

UNIVERSITY OF TORONTO



3 1761 01391402 3



Presented to
The Library
of the
University of Toronto
by

The Office of the Late
Dr. H.A. Cates



Digitized by the Internet Archive
in 2007 with funding from
Microsoft Corporation

FIVE GOOD PRACTICAL BOOKS

By JOSEPH V. WOODWORTH

These are practical shop books for all interested in accurate tool and die making, steel treatment, drop forging, die sinking, power presses and modern shop practice in the production of duplicate metal parts.

Dies: Their Construction and Use for Modern Working of Sheet Metals.

This is the only practical, authoritative book for the die maker and power press user. - - - - - Price **\$3.00.**

Hardening, Tempering, Annealing and Forging of Steel.

The most up-to-date book on steel treatment for the practical steel worker and the user of tempered steel cutting tools. - - - - - Price **\$2.50.**

American Toolmaking and Interchangeable Manufacturing.

A 20th century shop reference book on the very latest toolmaking practice, interchangeable manufacturing and machining of duplicate metal parts. - - - - - Price **\$4.00.**

Punches, Tools and Dies for Manufacturing in Presses.

A cyclopedia of die making practice, sheet metal formation in presses, and use of punches and dies. - - - - - Price **\$4.00.**

Drop Forging, Die Sinking and Machine Forming of Steel.

The only book published on these great branches of mechanical art and modern shop practice. A mine of practical information for the drop-forgers, die sinker and steel parts manufacturer. - - - - - Price **\$2.50.**

Power Presses: Their Feeds, Attachments and Safety Devices.

If interested in this book, send us your name and we will send a descriptive circular of it, on publication. (In preparation.)

 *Any of the above books sent prepaid on receipt of the price*

The Norman W. Henley Publishing Company

132 Nassau Street

NEW YORK

Drop Forging, Die Sinking and Machine Forming of Steel

MODERN SHOP PRACTICE, PROCESSES, METHODS,
MACHINES, TOOLS AND DETAILS

A Practical Treatise on

The Hot and Cold Machine-Forming of Steel and Iron into Finished Shapes: Together with Tools, Dies and Machinery Involved in the Manufacture of Duplicate Forgings and Interchangeable Hot and Cold Pressed Parts from Bar and Sheet Metal

Comprising

Die Sinking and Drop Forging Practice and Design for Modern Forging, Pressing and Stamping of Duplicate Parts . . . Die Sinking Methods, Processes, Machines and Tools . . . Drop Forging Dies: Their Design, Construction and Use in Drop Hammer and Forging Machine . . . Press Forming of Heavy Hot and Cold Stock in Dies . . . Drop Forging and Hardening Plants: Their Designs, Fundamental Conditions, and the Equipment Involved in Their Attainment . . . Steel and Iron: Their Treatment for Twisting, Reducing, Forging and Working in Drop Dies . . . Hot Pressed Steel and Iron Parts: Their Manufacture and Assembling into Finished Products . . . Drop Hammers: Their Development, Use, Weights, Foundations and Dies . . . Forging Machine, Steam Hammer, Bulldozer and Swaging Machine Methods and Processes . . . Machine Forging, with Examples of Modern Practice and Tools Involved.

By

JOSEPH V. WOODWORTH

Author of "*Dies: Their Construction and Use,*" etc.



CONTAINING 300 ILLUSTRATIONS

NEW YORK
THE NORMAN W. HENLEY PUBLISHING CO.
132 NASSAU STREET
1911

Copyrighted, 1911, by
The Norman W. Henley Publishing Co.



TEMg
W
574570
23.12.53

PREFACE

IN this work I have endeavored to produce a practical mechanical book, treating subjects comprehensively and thoroughly, which until now have been strangely ignored by writers and compilers of practical works on the mechanical arts. Although I searched carefully, I was unable to locate any work of value, published in any language, which treated practically and understandingly the arts of *Die-Sinking* and *Drop* and *Hydraulic Forging*. Only in the mechanical publications *American Machinist* and *Machinery* did I find articles and illustrations on the subjects which appeared to me to be of sufficient value to live; and I here acknowledge my great obligation to both these journals for the valuable matter which I secured from their columns and have now embodied in the contents of this volume.

I believe that the extensive development of the *Die-Sinking* art and the wide adaptation of *Machine-Forging* processes by all metal parts manufacturers, together with the meagerness of published information on the practise involved, make a work of this kind necessary, timely, and valuable.

The text of the treatise is concise; technical and ambiguous terms have been replaced by practical and familiar shop words; and all the illustrations and descriptions are plain and simple to understand. Thus, a thorough comprehension of the information and data contained in this treatise by the greatest number is assured.

The description of every subject and method involved has been boiled down to the simplest and fewest possible words; so that the "meat" of all may be arrived at and digested in the shortest time by the busy men of metals who will consult the pages following.

The hot and cold shaping, squeezing, forming, and bending of duplicate metal parts and high-speed steel cutting tools by forging in drop-dies, drop-hammers, steam-hammers, hydraulic presses, and forging-machines, are becoming more appreciated by the most advanced manufacturers and mechanics; but, until the publication of this work, to the average mechanic familiarity with the advanced shop practise, tools, and processes has been denied, because of the almost total lack of descriptive practical literature, and also the conservatism of manufacturers and experts in publishing their shop-practise and knowledge evolution. Therefore, to make possible among mechanics a broad and comprehensive knowledge of these arts I present this book, hoping it will find a valuable and permanent place in its field.

JOSEPH V. WOODWORTH.

BROOKLYN, N. Y.,
January, 1911.

CONTENTS

INTRODUCTORY.....Pages 7 to 10

CHAPTER I

DIE-SINKING AND DROP-FORGING PRACTISE AND DESIGN FOR MODERN FORGING, PRESSING, AND STAMPING OF DUPLICATE METAL PARTS

Drop-Forge Work—Materials for, and Life of, Drop-Forging Dies—Automobile Shop Drop-Forging Practise—Making a Die—Tools Employed in Making Dies—The Lead Casting or Proof—Staking Tools Used for Repairing Dies—Examples of Drop-Forging Dies—Trimming Dies—Heating Furnaces—Hardening Drop-Forging Dies—Die Practise for Accurate Forging—Method of Sinking a Drop-Forge Die—Micrometrical Forgings—Drop-Forging a Ratchet Drill Handle—Vanadium Forging Dies—Die-Sinking and Shop Practise in the Making of Cutting Tool-Holders for Machine Tools—Drop-Forgings on the Pacific Coast—Machining a Deep Forming Die—Dies for Finishing Bossed Levers—Sectional Dies—Materials Used for Dies—Principles of Drop-Forging and Stamping Large Parts—Removal of Fin Produced in Drop-Forging—Difference Between Treatment of Steel and Wrought Iron—Work with Holes Flanged Through It—Methods of Applying Impact or Pressure on Dies—Methods Used for Making Dies—Marking and Working Out Dies—Typing or Hubbing Process.

Pages 11 to 61

CHAPTER II

DIE-SINKING AND EMBOSsing PRACTISE METHODS, PROCESSES, MACHINES, AND TOOLS

Making Forces for Embossed Work—Properly Made Forces—Different Shaped Forces—Steel Forces for Flat Work—Copper and Brass Forces—Cutting the Impression in Die-Sinking—Riffles and Their Use—Drilling Out the Stock—Using the Breaking-Out Chisel—The Champney Die-Sinking Process—History and Evolution of the Process—Modeling, Casting, and Dropping—Driving Model Into the Die—Heating and Hardening of the Dies—Exactness of Size of Dies—Final Development of Champney Process—Die-Sinking Machines—Closed and Open Dies for Forgings—Value of Modern Machinery—Prevision and Supervision—Hob for Making Forging Dies.

Pages 62 to 93

CHAPTER III

DROP-FORGING DIES, THEIR DESIGN, CONSTRUCTION, AND USE IN
DROP-HAMMER, DROP-PRESS, AND FORGING-MACHINE

Combination Drop-Dies—Union Between Metal Parts—Die-Blocks and Impression-Blocks—Making Die to Resist Wear—Keying Wide-Seat Dies—First Principles in Holding-Dies—Bolt-Heading Dies—Forging-Press Dies for Making Hammers—Saving Unnecessary Movements—Making a Double-Faced Hammer—The Finishing of the Dies—Few Dies Needed for Forging-Press—Set of Tools for Forging a Fulcrum Bracket—Forging Dies for “Pin-Ends”—Forging Dies for Round and Square Upsetting—Drop-Forging Dies for Gun-Work—Unusual Job of Drop-Forging—Trimming Wrench Blanks in Dies—Trimming Cheap Hardware—A Slab-Truck for Forge-Shop—The Possibilities of Planing-Tools for Finishing Forgings—Work on Hand-Vise Forgings—Forging Under Steam-Hammer—Forging Large Pieces—Drop-Hammer Forging—Drop-Forging or Squeezing—Setting the Dies—Accurate Forgings—Forging High-Grade Steels—Effects of Alloying Materials—Hydraulic Press Gives Best Results—Heating Too Suddenly.
Pages 94 to 138

CHAPTER IV

DROP-FORGING AND HARDENING PLANTS:—DESIGNS, FUNDAMENTAL
CONDITIONS, AND EQUIPMENT INVOLVED IN THEIR ATTAINMENT

The Drop-Forge and Hardening Plant—Drop-Forge and Hardening Departments Under One Roof—Location of Die-Sinking Department—Board, Steam, Helve, Trip, and Drop Hammers—Plan of Modern Drop-Forge and Hardening Plant—Layout of Hardening Department—Advantages of Oil Fuel—Refitted Coal-Forges and Furnaces for Fuel-Oil—Arrangement of Piping—Finishing Department—Oil-Burning Forges and Heaters—Single and Double Opening Forge Furnaces—Top-Slot and End-Heating Forges—Installation of Forges—Burners—Brazing Furnaces—Heaters.....Pages 139 to 162

CHAPTER V

DROP-HAMMERS: THEIR DEVELOPMENT, WEIGHTS, FOUNDATIONS, AND
DIES

The Development of the Drop-Hammer—Counterbalanced Treadle—Compound Lever Device for Operating the Lifting or Head Mechanism—Jointed Swinghead Construction—Paper Pulleys

—Method of Fastening Board in Hammer—Foundations—Ratio of Base as Compared with Weight of Hammer—Foundations for Drop-Hammers—Drop-Hammer Effects—The Ambler Drop-Hammer—Securing Hammer-Heads—Hammer-Dies—Improved and Up-to-Date Drop-Hammer—Capacity of Steam-Hammers and Size of Work—Rules for Finding the Capacity of Steam-Hammers, and the Horse-Power Required for Operation—Development of Steam Drop-Hammers.

Pages 163 to 185

CHAPTER VI

STEEL AND IRON: TWISTING, REDUCING, AND FORGING—TREATMENT FOR WORKING IN MACHINE-FORGING

Action of Steel and Iron Under Different Degrees of Heat—Materials Used in Experiments—Fuel Stock in Tests—Practical Results of Experiments—Working Stock in Drop-Dies—Facilities for Reproduction of Drop-Dies—Spoiling Dies—The Dies and the Drop—Economy of Dies—Practical Effect of Working Iron—Effect of Drops on Stock—Working in Drop and Bending Machine—Improved Anvil Block.Pages 186 to 202

CHAPTER VII

PRESS AND HAMMER FORMING OF HEAVY HOT AND COLD BAR AND SHEET STOCK IN DIES, TOGETHER WITH MANUFACTURE AND ASSEMBLING OF FINISHED PRODUCTS FROM SUCH

Making a Wheelbarrow Wheel—Operations on Wheel—Making the Flanges—Pressed-Steel Gears—How Metal Wheels are Made—Wheel Tire Making—Steel Wheels—Early History of Chain-Making—A New Method of Making Weldless Chains—Dies for Weldless Chains—Modern Methods of Manufacturing Welded Chain—Former Method of Making Chain—Present Method of Making Welded Chain—The Link-Winder—The Link-Cutter—The Welding Machine—The Die—The Process of Welding.Pages 203 to 240

CHAPTER VIII

FORGING-MACHINE, STEAM-HAMMER, BULLDOZER, AND SWAGING-MACHINE METHODS AND PROCESSES

Handy Bulldozer Appurtenances—Tack and Tack-Dies—Tack-Making Tools and Their Action—A Rapid-Action Hydraulic Forging-Press—Tremendous Pressure of the Hydraulic Press—Operation of Process—Pressure for Small Work—Hot-Pressed

Nut-Machine—A Large Hydraulic Forging-Machine—Making Elevator Buckets with the Steam-Hammer—Locomotive Forgings made in Hydraulic Machine—A Job for the Heavy Swaging-Machine—Drop-Forging for the Ajax Forging-Machine—A Rock-Drill Used as a Steam-Hammer—Shear for Cutting Off Iron.....Pages 241 to 274

CHAPTER IX

MACHINE-FORGING, WITH EXAMPLES OF MODERN PRACTISE AND TOOLS INVOLVED

Machine-Forging — Manufacturing Connecting-Rods for Steam-Engines—Die for Turning Eye-Bolts—Forging with Dies in a Railroad Shop—The Advantage of Special Tools in Forging—Forging Without Special Tools—Ten Thousand Ton Press at the Dusseldorf Exhibition.....Pages 275 to 292

CHAPTER X

HYDRAULIC FORGING METHODS, AUTOGENOUS WELDING AND GENERAL SHOP PRACTISE

Hydraulic Forging—Description of Hydraulic Press—Examples of Production—Proper Practise for Hydraulic Forgings—Some Applications of Autogenous Welding—Heating Metal Before Welding—Fuel for Preheating—Welding Conclusions—Built-Up or Welded-Up Die Work—General Practise for Hardening Drop-Dies of Various Steels.....Pages 293 to 308

CHAPTER XI

HIGH-SPEED STEEL, DROP, AND HYDRAULIC FORGED CUTTING TOOLS, DROP-PRESS PRACTISE, AND HARDENING DROP-DIES

What is Good Judgment—High-Speed Steel and Tool-Holders—Combination Tool-Holders and Their Use—Economy in Use of Tool-Holders—Forging the High-Speed Steel-Cutting Points—The Drop-Press in Flat-Ware Operations—Foundations for Flat-Ware Drop-Presses—Holding Dies in Drop-Presses—Dies for Making Flat-Ware—Treatment and Use of Dies for Flat-Ware—Correct and Reliable Method for Hardening Drop-Hammer Dies Without Loss—More Losses in Winter-Time than in Summer—Temperature of Cooling Water—Have Plenty of Supply-Pipes for Water—Hardening the Die—Drawing the Temper—Cool the Die Thoroughly.....Pages 309 to 329

INTRODUCTORY

VERY little of value has been written on drop-forgings, die-sinking, the machine-forming of steel, and the shop practise involved, as it actually exists in the modern drop-forging shop. Here and there, a solitary die or device has been pictured and described, or a few sketches made of dies that may have been entirely imaginary, so far as can be learned from any evidence offered, and which are of such simple and elementary nature as to convey no adequate idea whatever of the magnitude and difficulty of the work to any one not familiar with it. This class of contributions covers the greater part of what has been published on a subject that has grown and developed from the hand-forging process of the hammer and anvil, to one of the most important branches of modern machine industry.

Hundreds of parts that were formerly cast from malleable iron, or hand-forged from bar stock, are now drop-forged, the extra cost being more than made up by the uniformity, strength, and reliability of the product; and no one has been quicker to realize this than the really live, up-to-date automobile manufacturer, to whom the mechanical world is indebted for so many other valuable mechanical developments.

The history of die-sinking and drop-forging goes back fifty years or more in New England. In the blacksmith-shops of the original "Yankee Toolmakers," a limited amount of work had been previously done in dies for as long a period, but only or chiefly in order to impart a "finish" to work which had been already hand-forged and nearly completed at the anvil. This practise was necessarily adopted in order to attain uniformity, in a number of similar forgings, economically. Such uniformity could only be produced on the anvil

with the common tools of the smith, at the sacrifice of much time and labor. Hence, long before the practise of *producing* forgings by drop-dies or machine forging, comparative interchangeability was eventually attained in anvil-made forgings by means of dies used in the power-hammer. The dies, even then, were often in sectional form, as they remain to-day when heavy forgings are required.

The making of drop-forging dies, together with the hardening process through which they are put and the methods of using them, is a trade by itself, though closely allied to tool and die making as understood in the big shops of to-day. Each branch of shop-work presents its individual problems, and a tool and die maker, though skilled in other lines, cannot go into a forging-shop and make dies without special instructions, training, and a knowledge of the practise involved.

In drop-forging die-work, as in other kinds of tool-work, there are various grades of accuracy and finish required. Some forgings must come from the hammer practically finished to size, while others are made large enough to allow considerable machining. Where only a few pieces of rough nature are required, little skill is needed in making or maintenance of the dies, but where small, accurate parts are to be made in large quantities, special tools for both hand and machine use are necessary, and trained, skilful diemakers are needed, as well as a careful selection of the steel used.

The employment of drop-forging and the production of hot and cold pressed parts of the nature referred to in the foregoing, are increasing constantly and rapidly. A large number of firms are now equipped with machinery used exclusively for this class of work, and they supply enormous numbers of forgings to manufacturers of metal-working machinery, automobiles, railroad-cars, car-parts, and innumerable users of metal parts.

Drop-forgings and pressed metal parts bear the same relation to the work of the blacksmith-shop that machine-molded castings bear to that of the foundry. In both cases, the skilled

mechanic and his labor are dispensed with. In each instance the finished product has the advantage of much greater accuracy and uniformity in shape and dimensions. The numbers turned from the dies, as from the molding machines, are often thirty to forty times as great as those which are produced by hand by skilled men. In both cases, too, the question of machining is often inseparable from that of the methods of production adopted, because accuracy of shape and uniformity of dimensions in forgings and castings alike are favorable to the most economical machining, since allowances which are either insufficient or excessive for the machines are equally undesirable and troublesome. The blacksmith working at the anvil, even with the help offered by templets and gages, is unable to produce two pieces—to say nothing of twenty intricate and elaborate pieces—absolutely alike, unless at an enormous expenditure of time. It is cheaper, therefore, and is the practise to leave plenty of surplus surface stock to insure that the work shall finish up all over when machined; otherwise the final finishing would occupy much time, even more than that required for the formative work of forging. But forgings which are dropped or machine finished—that is drop-forged—all come exactly alike from the dies; and interchangeability to the *desired degree* is attained in the initial process, without extra care or time spent on the part of the workman. Moreover, since the allowance, or surplus stock left, is small in amount and regular, pickling can be more usefully practised than when allowances are excessive.

The accuracy of forgings—machine and die produced—however, is further advantageous in the fact that a considerable amount of machining is often avoided altogether. The smooth, glossy, polished, and accurate surfaces left from the dies are often good enough for handles, levers, and numerous other parts. Or if they are required to be polished bright for good appearance, then a polished surface imparted by emery-wheel, buff, or tumbling barrel is sufficient, without any more machining in the lathe, shaper, or milling machine. Punched holes may be simply lapped, instead of being

drilled and reamed, the locations of the holes being fixed with accuracy by the dies.

The process of die-sinking relates to the engraving or sinking of the female or lower dies, such as are used for drop-forgings, hot and cold machine forging, swedging, and the press working of metals. The process of force-making relates to the engraving or raising of the male or upper dies used in producing the lower dies for the press-forming and machine-forging of duplicate parts of metal.

CHAPTER I

DIE-SINKING AND DROP-FORGING PRACTISE AND DESIGN FOR
MODERN FORGING, PRESSING, AND STAMPING OF DUPLICATE
METAL PARTS

DROP-FORGE WORK

Materials for, and Life of, Drop-Forging Dies

STEEL, cast into blocks, is not suitable for drop-forging dies, as flaws or blow-holes are likely to develop where least expected or desired; so, as a general rule, forged blocks of open-hearth crucible steel are used. These blocks are either purchased ready forged, in various sizes, from the steel manufacturers, or are forged in the shop where they are used—the former plan being the usual one.

A rough estimate as to the average life of a drop-forging die, used for medium-sized work on Bessemer steel, is given by a foreman of long experience, as about four thousand pieces. Some dies might be broken immediately when put in operation, while others might stand for a hundred thousand pieces or more.

Automobile Shop Drop-Forging Practise

The Figs. 1 to 22 and the data relating to them were obtained in the factory of Thomas B. Jeffery & Co., Kenosha, Wis. This company's drop-forging plant is far ahead of anything outside of the big concerns that make a specialty of drop-forgings, and consists of a well-lighted, finely equipped tool-room, used only for drop-forge die-work, a thoroughly up-to-date hardening plant, and a big building full of steam-hammers, punch-presses, heating furnaces, and every appliance necessary for first-class work.

The greater part of the drop-forgings made here are of Bessemer steel bar, though some of the more particular auto-

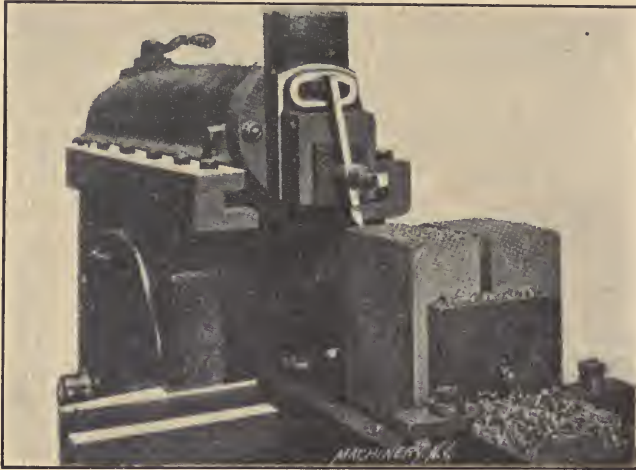

FIG. 1.—Planing a die-block on a shaper.

mobile fittings are made of special grades of tool-steel. All of the drop-forging dies are of the highest class, calling for

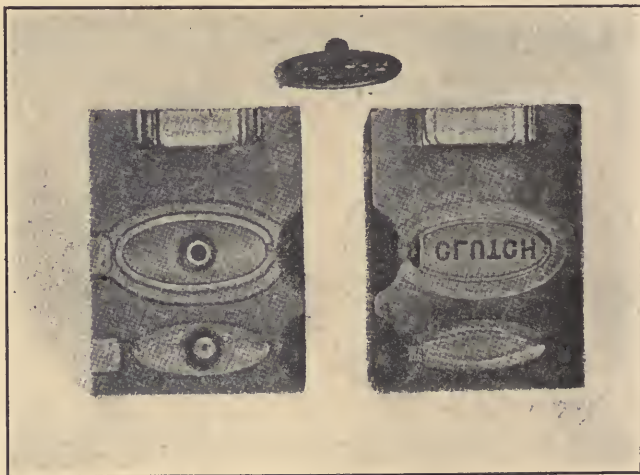

FIG. 2.—A pair of typical drop-forging dies and their work.

the best die-making skill, and necessitating a great deal of hand-work in addition to the most accurate machining.

Making a Die

In the original outlining of a set of drop-forging dies, the measurements for the forking cavities may be taken from a

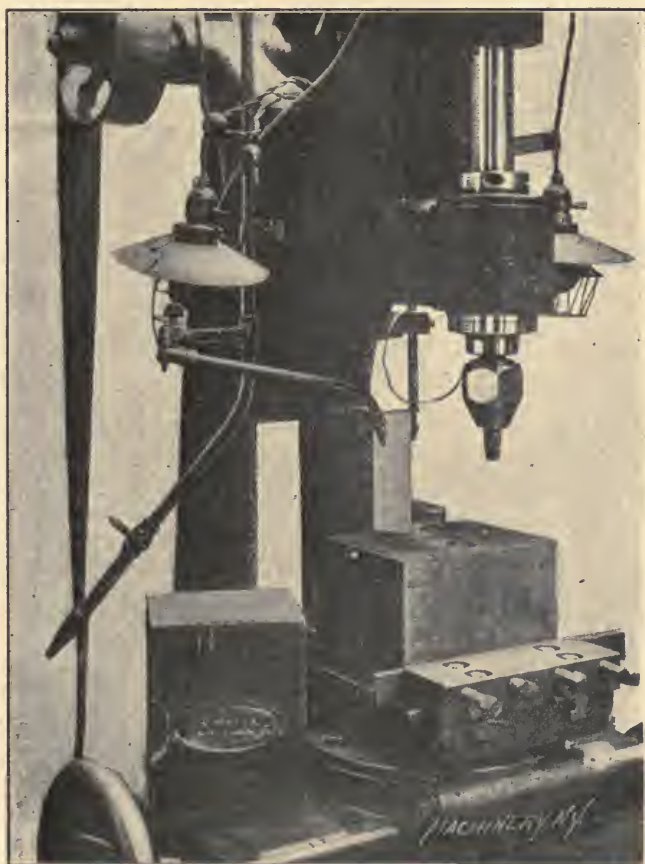

FIG. 3.—Profiling machine used in die-sinking.

blue-print supplied by the drafting-room, or they may be taken from a piece already made—possibly a forging or lead casting obtained from some former set of dies, or perhaps a

piece made up for a model. Sometimes a sheet-metal templet is made to assist in obtaining the desired shape of the die cavities, while in other cases only the outline scribed on the



FIG. 4.—Finishing die, Fig. 2, on the profiling machine, Fig. 3.

coppered surface, together with the necessary measurements, is needed. The size and outline of the forging to be made, as well as the accuracy required, govern the method of procedure.

The die-blocks, which, as already stated, are forged of open-hearth crucible steel, are first placed in a shaper and

carefully surfaced off to the required dimensions, as shown in Fig. 1. These blocks are always made oversize, so that enough of the surface can be machined off to insure good, sound metal to work on.

The outlines for the breaking down or roughing, the finishing, and sometimes the bending forms are then laid off on the coppered surface, and the cavities roughed out on the drill press or lathe, as the case may require, or on the profiling machine, as shown in Fig. 3. The same set of dies shown in



FIG. 5.—Special "Ball Vise" used in sinking drop-forging dies.

this figure is shown still further roughed out in Fig. 2. The shape of the forging to be made in this set of dies is shown at the top of Fig. 2, and it is a foot pedal for a clutch-lever. The channel for the fin, or "flash," which is formed in the finishing operation, is plainly shown in the middle cavities.

The letters C L U T C H, were first lightly stamped on the metal with special steel letters, to get the outline; then they were chiseled out, and finally finished by driving in the steel letters to smooth up the roughness caused by chiseling.

Fig. 4 shows the final cuts being taken on the breaking-

down part of this die, the rest of the work consisting of scraping, gouging, and chiseling.

Tools Employed in Making Dies

For the hand-work, the die is held in a special "ball vise" which is shown in Fig. 5. A vise of this type is the handiest device imaginable for heavy die-work. This illustration also shows the breaking-down part a little more clearly than the previous examples.

Fig. 6 shows a few of the tools, scrapers, and rifiers used in the finishing work. These are mostly made of old files,

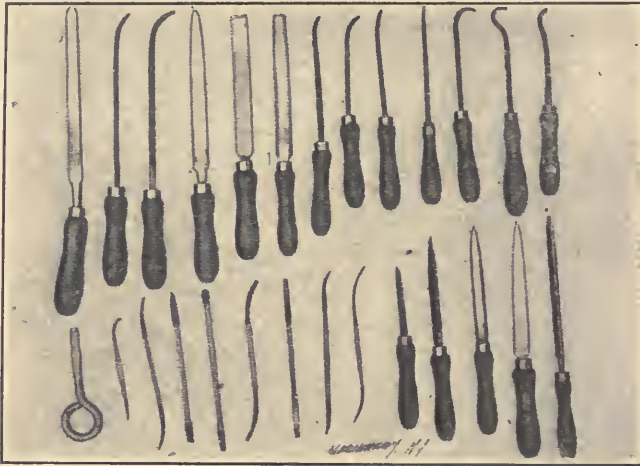

FIG. 6.—Scrapers, files, rifiers, etc., used by die-sinkers.

and are ground or bent to suit the needs of the particular cases.

In Fig. 7 are some of the milling tools that have been made especially for this work. Only twenty-four of them are shown, though several hundred of all shapes and sizes are in stock. Another set of special cutters is shown in Fig. 8. Two of these have a single inserted blade or "fly-cutter" held in place by a set screw, and are very useful tools for some kinds of work.

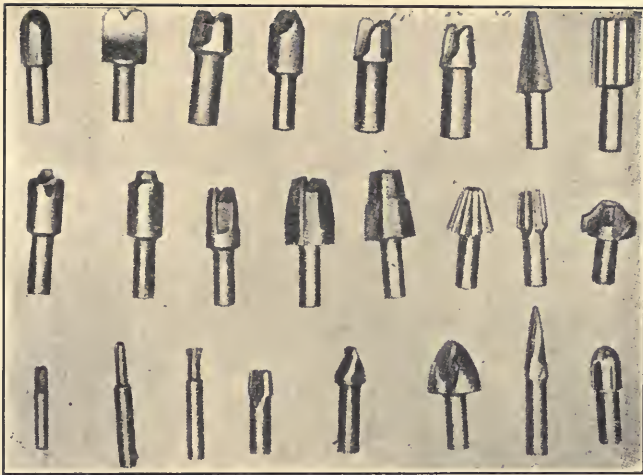

FIG. 7.—A few milling-tools used in die-sinking.

The tools shown in Fig. 9 are known as “types,” and are used in scraping out cylindrical cavities to size. These types are turned to the proper size, and when used are smeared with

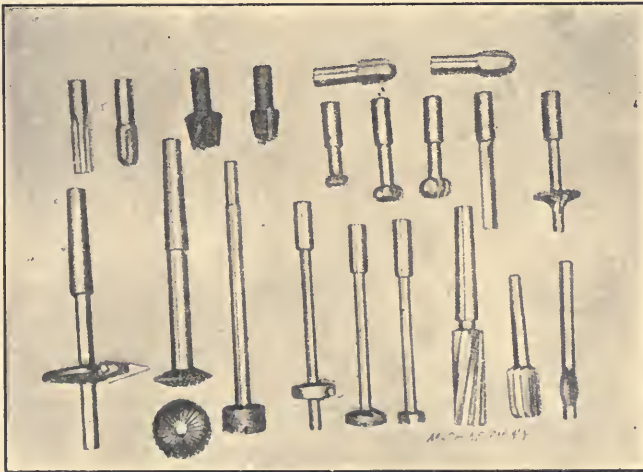

FIG. 8.—Milling-tools used in die-sinking, with example of fly-cutters.

red lead and rocked back and forth in the partly finished cavity. The metal is then scraped away wherever the lead shows. For cylindrical work, these types are indispensable tools.

The tools shown in Fig. 10 were made by one of the expert die-sinkers in the Jeffery shop. The tool shown at the right is used to scribe an outline from a forging. It consists of a hardened steel blade, with a point on one end, set into a flat steel block in such a way that it is free to move up and

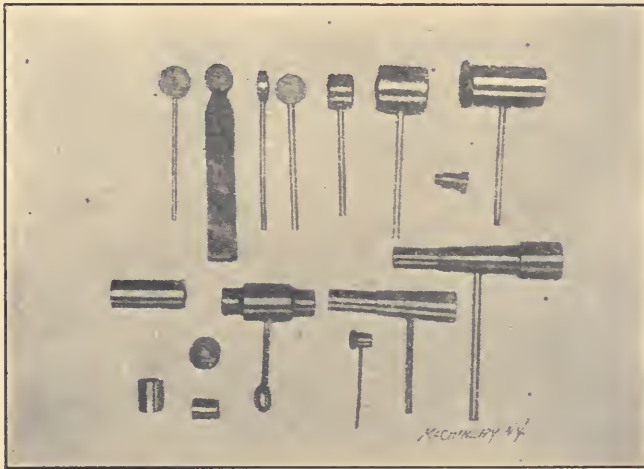

FIG. 9.—“Typing” tools used by die-sinkers to form circular cavities.

down to a limited extent. The rivet shown on the side is passed through a short slot in the blade. When in use, a flat spring on the top edge of the tool presses the point downward onto the coppered surface, causing a mark wherever moved. To use this tool, it is held on edge with the point down and the edge of the hardened blade in contact with the forging. The steel block keeps the blade perpendicular, and by keeping the edge of the blade in contact with the forging while scraping, a correct outline is obtained, which could not be done with an ordinary scribe on account of the working outline being considerably above the die face.

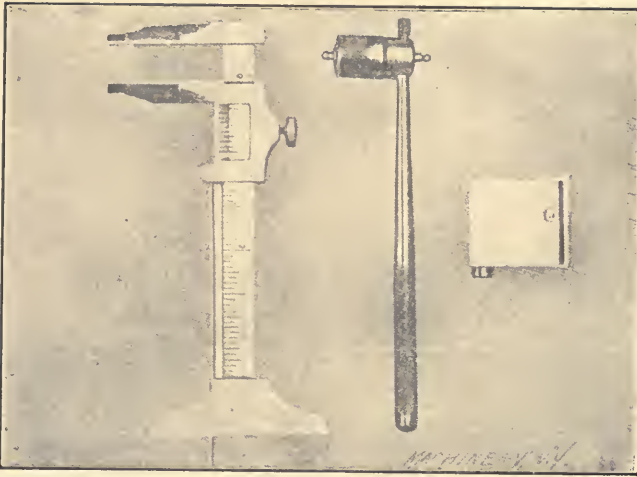

FIG. 10.—Vernier caliper-depth gage, inside micrometer and scribing-block.

The middle tool shown in Fig. 10 is a one-inch inside micrometer, which was made by the die-sinker because he could not buy one small enough for the purpose. The other



FIG. 11.—Samples of lead-castings or proofs from drop-forging dies for testing accuracy of outline.

tool is a regular stock caliper square, to which has been added a depth gage. The gage is made so that the rod projects the same distance that the caliper jaws are apart. The usefulness and convenience of this tool are at once apparent to a tool-maker.

The Lead Casting or Proof

After the mechanical work on a set of dies is done, a lead casting of the cavity is made and sent to the superintendent



FIG. 12.—Staking-tools used for repairing dies.

to be passed upon. If it is correct, the dies are hardened and sent to the forging-shop, but if it is off size or shape, or for any reason not satisfactory, suitable changes are made, and another lead impression taken and passed upon as before. Fig. 11 shows a number of these lead castings, which are kept in the tool-room for reference, and they often save considerable trouble when duplicating dies.

Staking-Tools Used for Repairing Dies

After a set of dies has been in use for some time, the dies are likely to develop cracks or drawing seams which cause

ridges and rough spots on the forgings. These cracks are closed up by hammering first on one side and then on the other with a hammer, and what are called "staking tools," which are simply special shaped, tempered steel punches made of chisel-steel stock. Some of these staking tools are shown in Fig. 12.

Examples of Drop-Forging Dies

One-half of a die set, showing the breaking-down and finishing forms, is illustrated in Fig. 13. In this illustration

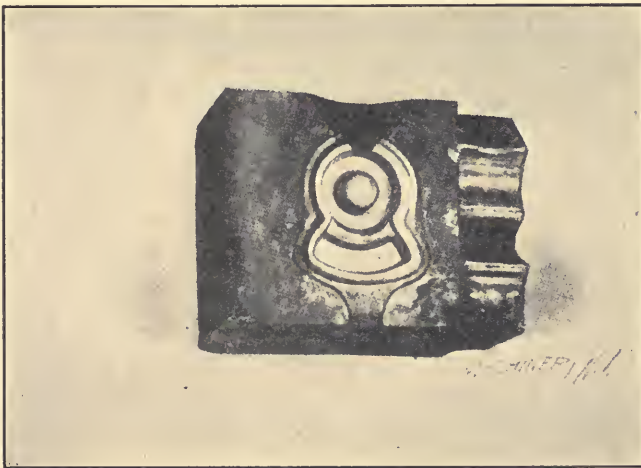

FIG. 13.—An example of drop-forging die, showing breaking-down die at the right.

the method of leaving a ridge around the finishing form and cutting a channel for the fin is very plainly shown. This method is followed in all of the drop-dies made at the Jeffery shops. Fig. 14 shows a more complicated die. In this, both edging and flatting breaking-down die forms are shown. In using this die, the hot bar from which the forging is being made, is alternately swung from one to the other form, it being held edgewise in one and flat in the other, and given a blow or two until sufficiently reduced for the finishing form,



FIG. 14.—Drop-forging die, showing both edging and flattening breaking-down dies.

after which it is cut off from the bar by a shear fastened to the hammer at one side of the die-block.

In Fig. 15 the roughing or breaking-down die is shown, and also a bending form, the bar being roughed into shape,



FIG. 15.—Drop-forging die, showing bending-form in front.

and then bent and finished. Of course, in these two last illustrations it is understood that the cuts show only one-half



FIG. 16.—Drop-forging die and bending-die for steering gear part.

of the set, the other half corresponding in shape to the one shown in such a way as to produce the desired shape. To

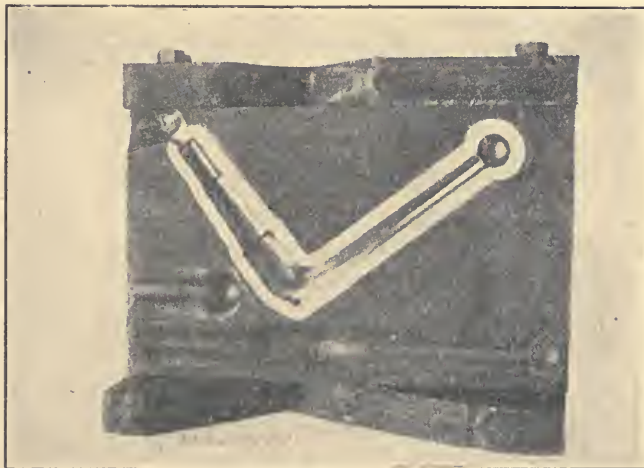

FIG. 17.—Forging die to die in Fig. 16.

better illustrate this for the benefit of those not familiar with the class of work, both halves of a set of dies are shown in Figs. 16 and 17. These show the complete forging and bending parts for this particular piece. The end of the finishing form also shows a place where one of the types illustrated in Fig. 9 was used when first working out the cavity.

Trimming Dies

Some of the forgings are of such shape that the fin or flash produced is easily ground or machined off, while others are

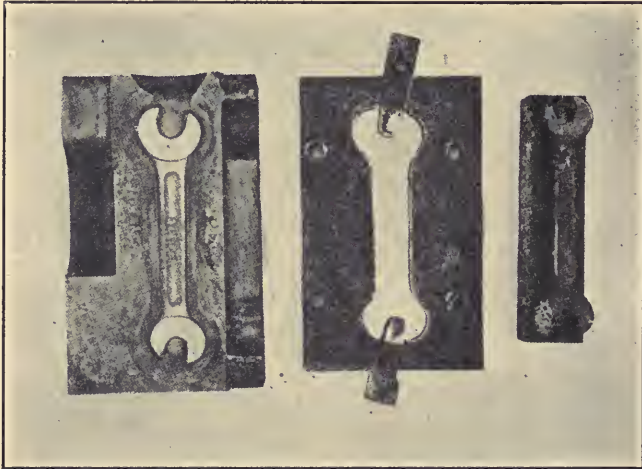

FIG. 18.—Drop-forging die for wrench and trimming-die for same.

put through a trimming-die. These trimming-dies are about the same as the trimming-dies used for other classes of work, and so need but little description. Fig. 18 shows a set of forging and trimming dies used for making automobile wrenches. The breaking-down form is very plainly shown, as is also the finishing cavity. The trimming-punch is at one side, while the trimming-die in the middle is shown made up of four separate parts. This is done because the die parts that shear out the wrench slots wear or break sooner than the rest of the die, and when made this way they are easily

replaced without necessitating a wholly new die, which would be the case if made solid.

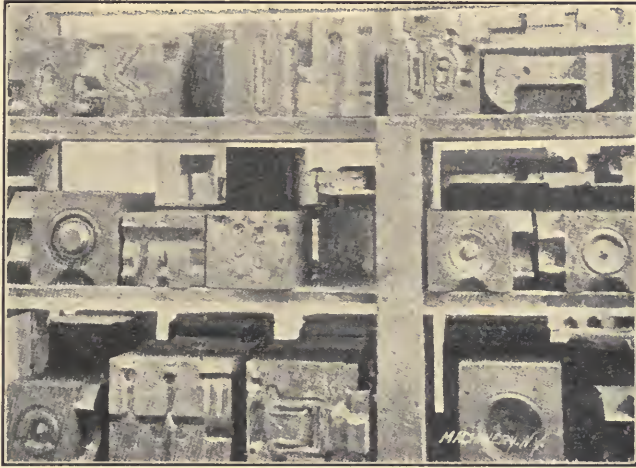

FIG. 19.—A few examples of drop-forging dies in storage

Fig. 19 shows a number of dies on the storage shelves, only one-half of each being shown, the other half of each set



FIG. 20.—Oil-heating furnaces and drop-hammer.

being back of the one visible. The trimming-dies which are in constant use are kept conveniently near the presses in the forge-room. Both trimming and forging dies are stored on heavy shelves close to where they are used, thus saving the unnecessary "toting" that is practised in so many shops.

Heating Furnaces

The heating furnaces in a forging-shop must be set near the hammers, and Fig. 20 shows how the oil furnaces are

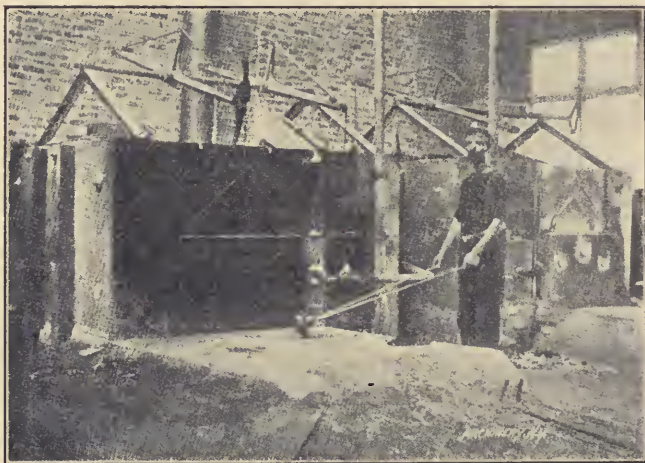

FIG. 21.—Brown & Sharpe heating and annealing furnaces

placed, so that little time is lost in getting the heated metal to the hammers. Fig. 21 is an illustration of two of the big Brown & Sharpe furnaces in the hardening-room. For small work several smaller furnaces are used, but those shown are used for large work, and are said to be the best obtainable.

Hardening Drop-Forging Dies

In hardening drop-dies only the face is hardened. The die is heated and placed face down in a tank of water on a sort of a spider support, and a stream of water pours upward onto it. Fig. 22 shows how this is done. In the illustration a

round piercing die is being hardened, so that the water appears to be boiling up through the center, which would not be the case were it a solid block like a forging die. Large special shaped tongs make the handling of the heavy steel blocks of the drop-forge dies comparatively easy.

Die Practise for Accurate Forging

The tendency of late years to turn out a better class of forgings than formerly is becoming general, I am glad to say,



FIG. 22.—Hardening the face of a drop-forging die.

and the adoption of machinery for this class of work is, I know, accountable more than anything else for the improvement; the desire to cut off work in the machine-shop being also a factor. Be that as it may, the dies for such nice and accurate work must first pass through the machine-shop. It is a pretty rough and scaly job that comes from dies that have not been properly fitted up to match accurately and with a smooth finish.

In the production of good work, the metal of which the dies are made is of the first importance. While gray iron answers the purpose for a time, such dies soon batter and

crush, and the scale from hot iron wears into the surface and causes rough work, unless they are overhauled frequently. Basic steel would be an improvement if the blow-holes could be eliminated, but it seems that few perfect castings are produced of this material. Tool-steel is very costly, but from my experience it fully pays for light dies where forgings are standard and got out in large numbers.

The plan I have followed to save steel answers the purpose very nicely, and only takes about one-third stock as ordinarily used. Fig. 23 shows the blank steel for the die-face,



FIG. 23.—Steel blank for die.

shaped for the purpose under a steam-hammer. Fig. 24 is a cast-iron die-holder, fitting and keyed into the anvil-block as in ordinary practise. A $\frac{7}{8}$ -inch steel pin is driven into the center deep enough to give it a good bearing—about $1\frac{1}{2}$ inches deep—with the top tapered and projecting about 1 inch to let into the steel face. This secures the steel face to its place and two keys driven, one from the back and the other from the front, complete the arrangement as shown in Fig. 25. The cast die-holder answers for all different shapes used, and does not have to be removed unless it is wanted in machining the dies.

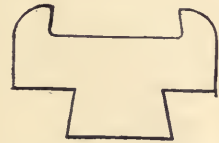

FIG. 24.—Cast-iron die-holder.

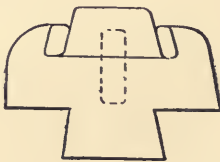

FIG. 25.—Die-holder and die assembled.

The shapes should be made $\frac{3}{4}$ inch large and the recesses as smooth as possible, and if sprayed with water when in use they give a nice finish to the forgings if the fuel is clean and free from sulfur.

Oil is very largely used now for heating forgings, and it certainly does nice work, and leaves the iron with a surface without holes or scarred places, besides making the iron easier to work and heating the piece uniformly. From

my experience with oil for heating and with steel dies for the hammer, I can say that there is no reason why forgings cannot be made which will require practically no machine-work and very little grinding and file-work to make them fit their respective places.

Method of Sinking a Drop-Forge Die

To sink a pair of forging dies for the breech or butt of a gun involves a great deal of hand-work and a considerable amount of care, if one is to do a good job. There were several pairs of such dies to sink at one time, and the purpose here is to show my readers how a scheme was devised to make the machine help some on the job.

The die-maker was too much of a Yankee to have a great desire for hard work, and if there was any ahead of him he was apt to work his gray matter overtime if necessary to get a scheme to avoid it. The one shown by the sketches in Fig. 26 did not eliminate all the hand-work, but it did help a lot.

A shows the piece which was to be forged—the well-known butt plate of a military rifle. The dies were what are termed “match face,” and are shown by *b* and *c*, *b* being the bottom and *c* the top die in the drop.

The plate was to be redropped—that is, forged, pickled to remove scale, and redropped at a heat so low that it would not scale, thus giving a surface which could be finished on the polishing wheel, and the edges only were machined.

The entire bottom of the first pair was chipped and filed, and when samples were secured the military inspector put his micrometer on them just as cheerfully as he did on a piece of machined work, and insisted that they come within two thousandths of the drawing at the two thickest points, they being the only places where he could apply his caliper. All argument was in vain; he must have some samples like the print, and to get them out of this pair of dies involved a lot of scraping and grinding on the tempered die, accompanied by lots of uncharitable remarks about the inspector.

Visions of the pairs of dies to follow haunted the die-

maker in the small hours of the night, and caused the making of the former plate *d* and cutter *e*, which solved the problem nicely.

The line *k* on *d* was filed as near to shape as possible, secured on the die *b* by the pin-holes shown, and a cut made

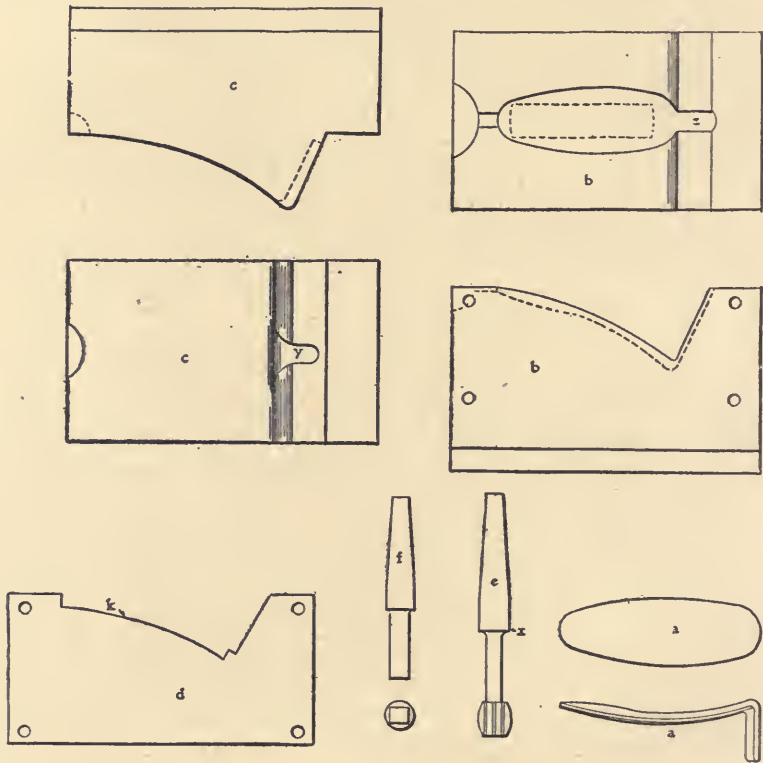

FIG. 26.—Die-sinking for butt plate of a military rifle.

with the cutter *e*; *x* acting as a former-pin, a strip of lead was then placed in the cut and the dies squeezed together, giving a form which could be measured with a micrometer, and by filing and cutting in this manner the die-maker was able to get a templet or former that corresponded exactly with the drawing. With this former and the cutter *e* the dies were quickly machined, as shown by the dotted lines on *b*, and an

accurate outline secured at every point where the inspector could apply his gage.

There were lots of chipping and filing left still, but the cut, exact as to form and depth, was a great help and gave assurance at the start that the die would be O. K. at the points where it could be measured, and a lot of time was saved on the job.

The cut y in c was easily machined, and the cutter f was made to machine z in b , the spindle being stopped and the machine used as a slotter, which did the job much better than it could be done with chisel and file, and in a fraction of the time.

The dies warped very little in tempering, and samples were secured which were quite satisfactory, though I doubt if the methods used to make them would prove profitable commercially.

Micrometrical Forgings

It may surprise my readers to learn that work is sometimes inspected in the smith-shop with a micrometer, the limit allowed for variation being only .002 inch, which is ordinarily considered fairly close for machine-work. This is a matter of common practise in some places, however, and is not considered anything out of the ordinary.

In the sketch, Fig. 27, a is a fair sample of a piece of work of this class. It is a punch used by boiler-makers for riveting holes in sheets. The only finish required on these punches when they come from the hammer is on the ends, the body being simply polished. They are forged in the ordinary cushion hammer, and to make a pair of dies for the job it is necessary to make a cutter or "cherry," sketch b , and a back rest and follower screw, c . The shank of the cutter is very light, and under ordinary circumstances it would be impossible to sink it in the die, but with the use of a back rest it is supported so that it cannot crawl sideways, and the follower screw holds it up to the work and prevents springing the shank. In this way the shank has nothing to do but to turn the cutter; it is not subjected to any side or bending strain,

and allows the use of a very delicate shank if care is used in feeding the cut. In tempering, care is taken to get a good temper the whole length of the shank, for if left soft it is very apt to twist off. As tempering is very apt to spring it, before it is used it is placed in the machine after drawing the temper and peened with a punch until it runs true.

In *f* is shown one-half of a pair of dies, which, of course, in

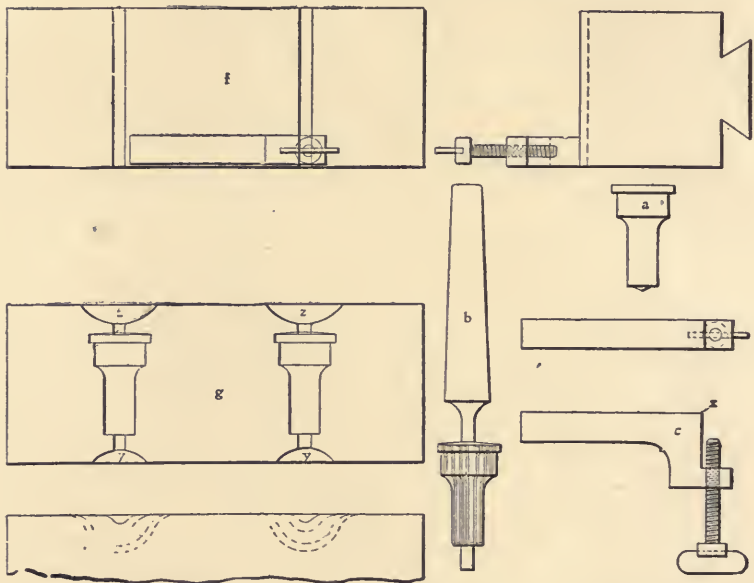

FIG. 27.—Micrometrical forgings and their making.

this class of work are always duplicates, and which, as a general thing, have two impressions. The first operation is to run a light cut with a routing tool across the face at the point where the impression is to be made, using care to cut the same depth in each die. They are then clamped securely together, face to face, and drilled and reamed, making the half hole as shown, the light cuts previously taken serving to guide the drill straight and insuring an equal depth in each half. One-half of the die is now clamped securely to the slide of a die-sinking machine and the back rest *c* is placed as shown, the corner

x being placed flush with the side of the half hole. An ordinary C-clamp is generally used to fasten the back rest.

The "cherry" is now placed in proper position in the machine, and it simply requires careful manipulation of the hand wheel of the machine and the follower screw to sink to half its diameter in the die. The shank of the cutter serves as a stop, and the half hole prevents cutting too deep.

As this is a roughing operation, the cutter is not forced entirely down at this time. This operation must of course be performed four times to make a pair of dies with two impressions. All of the impressions being roughed out, the dies are placed loosely on the platen of the machine and brought together on the "cherry," and an ordinary pattern-maker's clamp is used to force them together. At this time, if the cutter is very delicate, it is a good plan to turn the machine by hand, as it is apt to catch on the corners, and it is an easy matter to lose the cutter at this stage of the work. It is necessary to open the dies several times in this operation to free the cutter from the chips, as there is no place for them to work out. Thick, soft card-board is often used between the dies to prevent closing up too fast under the pressure of the clamp.

We now have a die as shown in *g*, the cuts γ and z being made for stock clearance. The cuts z should be carried as close to the impression as the strength of the dies will permit, as the stock which is drawn down at this point must run out into a sprue, and thickness here means waste of material. The corners of the sides of the impressions are now well rounded off with chisel and file, as shown by dotted lines in *g*, the ends of the impression being left square.

This done, the dies are ready to temper, and if badly warped in tempering they are frequently ground on a surface grinder, though it is not necessary to true up the entire surface. The dies are now clamped together and a lead cast is taken of the impression. If it measures too large, of course a little more may be ground off the faces, but if too small, a lead lap must be made and the impression ground out. We are now ready to place the dies in the hammer and begin forging.

The hammer-man knows by experience how far to place his red hot bar of tool-steel in the die to give stock enough to fill it. Of course if he takes too much, the surplus will force out through the hole in the end. To get a forging that exactly corresponds to the dies, it is necessary to hold the bar in place until the dies come together fair, it is of course being turned all the time by the hammer-man. It is impossible to get one of these forgings too small, but if the work is done by the piece it is sometimes taken from the hammer before it is down to size, and we have frequently seen a hammer-man called to account because his work was over the .002 limit which he was allowed. This gives an illustration of a case where an inspector uses a micrometer in the blacksmith-shop to good advantage.

Drop-Forging a Ratchet Drill Handle

Fig. 28 of the accompanying drawing is a shell and handle for a ratchet drill, and Fig. 29 shows the piece of stock from which it was made. The width of the bar of stock to be used was determined by the length of the shell, and the thickness was a trifle more than twice the thickness of one side. The length was determined by experimenting until the proper length was found.



FIG. 28.—Drop-forged shell and handle for ratchet drill.

Fig. 30 shows the first operation, which was done on a cushion hammer with a pair of dies shown in Fig. 31. The operation required considerable skill in the operator, but made a nice job if the piece was properly handled. The stock for an entire order was cut to length and each piece put through the first operation. The second operation, shown by Fig. 32, requires another handling.

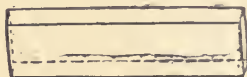

FIG. 29.—Stock for forging Fig. 28.

The dies for this operation are shown in Fig. 33. They were of cast iron and contained two splitting chisels and an expanding mandrel, as shown. *X*, in Fig. 33, is a steel stripping-plate to draw the forging from the mandrel after the forging blow is struck. Two blows with this pair of dies were necessary. The first one with the splitting chisels formed the piece as shown in Fig. 32, and the second one expanded, as shown in Fig. 34. The expanding mandrel was slightly larger than the forging was to finish, so that the mandrel used for the finishing operation would drop freely into place.



FIG. 30.—First operation on Fig. 28.

In the second drop was a pair of steel finishing dies that were duplicates, one of which is shown in Fig. 35. The amount of stock was calculated so nicely that very little fin was made and the

piece was not trimmed hot at all. The flash is shown surrounding the piece of work.



FIG. 31.—Dies for Fig. 30.

This job was designed by a boss blacksmith who has since joined the majority.

He was a fine old gentleman and a No. 1 mechanic, and the greatest crime he knew was to waste stock in performing a forging operation.

He came to grief one time, however, on this particular job, and wasted material for an entire lot. It was necessary that the iron should be first-class to stand the strain of splitting. Knowing this, he always made a few samples from each lot of iron to test it; but one time, for some unaccountable

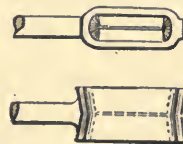

FIG. 32.—Second operation on Fig. 28.

reason, he failed to take this precaution, and of course this must be the particular time when the stock was poor.

He cut off the entire lot and drew down the handles, and

when he started the second operation nearly every one of them split at the end, and there was nothing to do but scrap the entire lot.

This confirms the generally understood fact that, however capable and competent a man may be, he at some time or other relaxes his vigilance a little, and it seems as though this happened in most cases when he should have been more alert than ever.

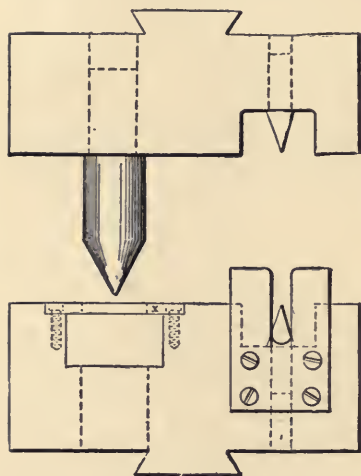

FIG. 33.—Dies for Fig. 32.

great in fact as to be in some instances very noteworthy. For example, in a ship-building yard on certain severe work, pneumatic hammer riveting dies, made of the best carbon steel obtainable and treated in approved manner, lasted only about ten hours each. The vibrations crystallized the shanks of the dies, the result being breakage at the junction of the shank and the die proper. When these carbon steel riveting dies were replaced by vanadium steel dies, their life was greatly extended, fourteen months service being reported by one concern using this alloy for its pneumatic riveter dies. In my opinion Vanadium steel is the best all around die steel and cutting-tool steel to-day.

Vanadium Forging Dies

The severity of the service on riveters and forging dies, boiler punches and other tools in similar cases, often makes the upkeep abnormally expensive, even when the best carbon steel is used. It is in such trying situations that certain alloy steels have shown marked superiority—a superiority so

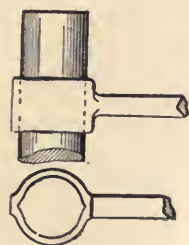

FIG. 34.—Expanding the shell.

Die-Sinking and Shop Practise in the Making of Cutting Tool-Holders for Machine Tools

In the manufacture of some drop-forged cutting-tool holders for machine tools, and similar shaped articles, the parts are case-hardened by being packed in large boxes with raw bone and charcoal, and heated in furnaces in the usual way. The method of handling the iron boxes is not however as common as it might be. These boxes are made with grooves or corrugations on each side, extending the entire length of the box, and a large iron fork, the prongs of which just fit these grooves, and which is swung from one traveling tackle, is used

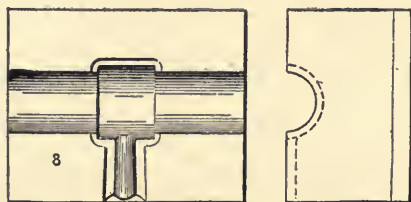

FIG. 35.—The steel finishing-dies.

to put the boxes into the furnace and to remove them when they are sufficiently heated. When the boxes are removed the contents are dumped into the cooling tank, which is fitted with a screen to keep the parts off the bottom and insure more even and thorough cooling, all of which is necessary to insure a uniform condition. The screen just referred to can be easily removed to clean the burnt bone out of the bottom of the tank.

The tool-holder set screws, which are made of tool-steel, are heated in special furnaces that heats only the points and drops them into the hardening bath as fast as the operator can feed them in. The burner of this type of furnace is the same as that used on a bicycle brazer, and, in fact, the furnace is principally made from the parts of an old brazing stand.

Naturally, in a shop depending so much on drop-forgings, the die-making department is one of the most important in

the works and is well equipped. This department is in charge of a man of long experience on this class of work. One of his remarks hits the drop-forging die problem squarely on the head, and it is that the great difficulty in drop-forge work is not so much in making the die, but in making the metal go into it, meaning, of course, that the breaking down, roughing or bending operations are really the most important and the most difficult to plan out properly. Almost any tool-maker can sink a finishing die from a model, but it takes brains and



FIG. 36.—View of drop-forgings as they appear when taken from dies.

experience to plan and work out the other parts of the die so that it will work satisfactorily without unnecessary waste of time and material. In planning dies or die parts of especially difficult shapes, plaster-of-Paris models are often used in order to find the best shape or position for the part to lie in; this is especially important in so planning a die as to get that great desideratum of the drop-forge shop—the finishing in one heat.

Fig. 36 shows a number of drop-forgings, including tool-holders, wrenches, drifts, and a C-clamp, with the flash still in place. These forgings are just as they come from the steam-hammer. A trimmed-off flash is shown on top of the large C-

clamp in the middle of the group. Fig. 37 shows a lot of lead proofs of dies for making various sizes of drop-forgings, from the smallest to the largest. The big C-clamp shown is 18 inches long, and the sizes of the other parts can be judged from it. For very large forgings, such as the C-clamp mentioned, cast-iron dies for roughing and forming are used. The piece is first broken down, bent, and rough-formed in these dies, and then reheated and refinished in the tool-steel finishing die. Fig. 38 shows a set of wooden patterns for a



FIG. 37.—Lead proofs of various parts which are to be drop-forged.

pair of cast-iron dies weighing 1,600 pounds, or 800 pounds apiece.

Many small pieces are forged in "pony dies," which are made of a shoe of tool-steel two or three inches thick, which is keyed into a heavy cast-iron or cast-steel block. These pony dies are very economical, as one set of shanks can be made to do duty for a large number of shoes. The shoes can all be located by dowel pins and keyed in with a taper key, in the same way that the shanks are keyed into the steam-hammer anvil and head.

For working out difficult dies on the profiler, the univer-

sal angle-plate or profiling-block, familiar to users of universal milling machines, is used. These blocks are made so that the top may be swung around in a complete circle, while the body can be tilted two ways, about 45 degrees, and clamped at any point on the base. These adjustments give almost any angle required in die-sinking, that cannot be obtained in the regular profiler vise.

The making of dies for the "Armstrong" boring tool, so that the metal would come out of the die, was quite a difficult

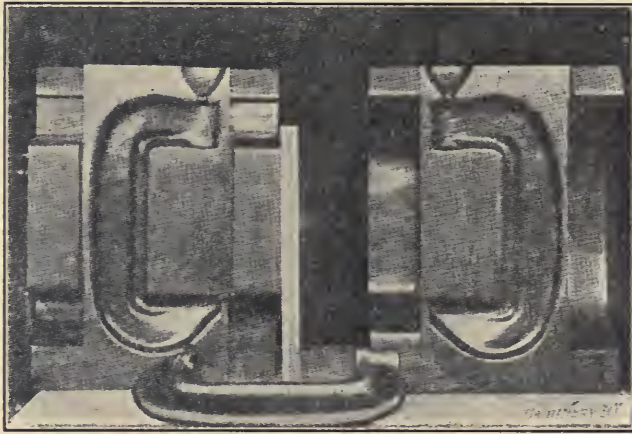

FIG. 38.—Wooden patterns for a pair of heavy cast-iron dies.

problem. This was one of the few cases where getting the metal *into* the die was not the most important thing. It was easy enough to make a die that would forge up the shape required, but owing to the peculiar shape of the boring tool the metal would be wedged in too tight to be easily removed. This problem was worked out by using plaster of Paris in the way previously referred to, and the die, as it was finally successfully made, is shown in Fig. 39. One of the boring-tool holders is shown lying on top of the die. The truck shown in this illustration is very useful, as it is just the height of the work benches and a heavy die can be easily pushed from one to the other.

Drop-Forgings on the Pacific Coast

The Pacific coast offers a good field for a well-equipped die-sinking and drop-forging establishment. At the present time (1910) the only plant of its kind is in the construction department at the Mare Island navy yard. In this depart-

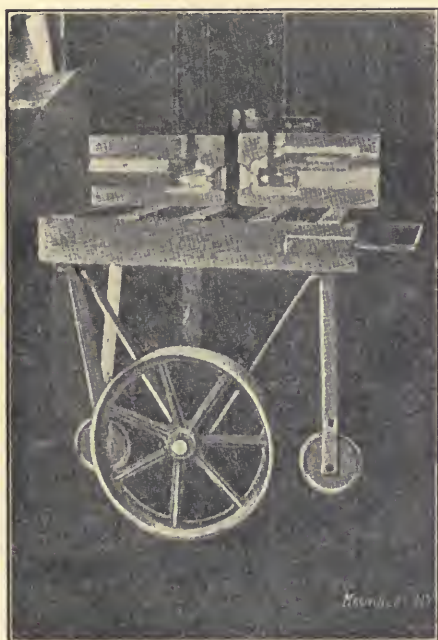

FIG. 39.—Dies in which a boring-tool shank is forged, and a convenient form of shop-truck.

ment there is sufficient work to keep four die-sinkers and one drop-forgers busy constantly. Their work has greatly reduced the manufacturing costs of forgings. The die and forge shops were put in operation in 1905. The die-room is located in the machine-shop, and the forge-room in an annex to the blacksmith-shop.

In the die-shop there are two die-sinking machines, two-lathes, two shapers, a drill-press, a die-slotting machine, a surface grinder, and the usual small tools and work benches.

In the drop-forge room there are: One 1200-pound hammer, one 2400-pound hammer, two trimming presses, one forging furnace and one furnace for tempering dies.

By standardizing ship-fittings and manufacturing them in quantities for stock to be used as needed, the cost of this class of work has been greatly reduced. Before the establishment of the drop-forge plant all such fittings were made as needed,

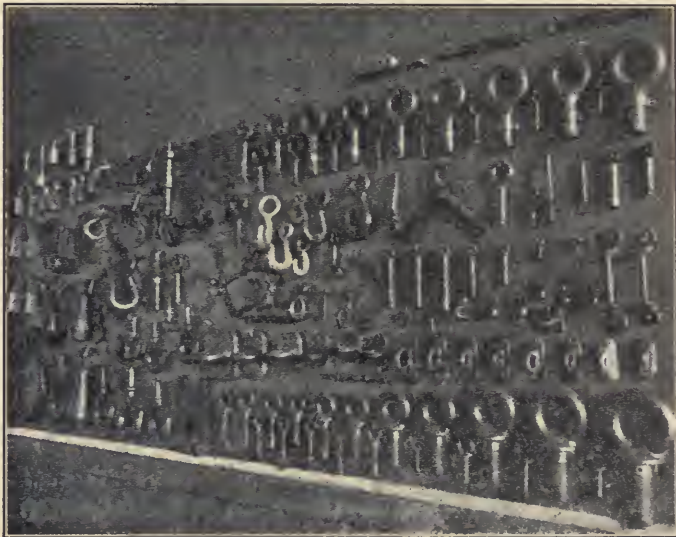

FIG. 40.—Drop-forged ship-fittings.

a few at a time, by hand in the blacksmith-shop. The cost was necessarily high; especially so as wages on the Pacific coast were high. By standardizing such fittings and manufacturing in quantities not only is the cost materially reduced, but also the delay of waiting is eliminated. In the case of urgent repairs to ships, delay in any part of the work is of great importance. The illustrations in Figs. 40 and 41 show the general class of fittings that are drop-forged.

High class die-steel is not used, as it is found that for the kind of fittings manufactured the lower-priced material answers equally well. There is not only much less cost of

material, but also of labor, owing to greater ease of working the softer material. The die material is purchased in open-hearth billets, 10 feet long, of the proper sizes, and is cut to required lengths for dies. For dies that will receive hard wear, steel of 0.60 per cent. carbon is used. For the general run of dies, steel 0.40 per cent. carbon is used. These classes of material cost, delivered at the Mare Island yard, about 3 cents per pound. This is less than half the cost of high-grade die-block steel. It is, of course, necessary to use cyanide in tempering these dies. The character of the dies used is shown in the illustrations, Fig. 41.

Dies for very accurate work are made from high-grade steel,



FIG. 41.—Specimen drop-forge dies for ship-fittings.

for the reason that this material stands up better under the hammer than does the open-hearth steel of 0.40 to 0.60 per cent. carbon content. For ordinary fittings, as shown in the illustrations Fig. 40, slight sinking of the impression makes practically no difference; the fittings are of such a type that absolutely accurate dimensions—within a few thousandths of an inch—are not required.

Careful observations were made of the dies after a thousand or more forgings had been made, and it was found that some of the impressions had sunk a maximum of 0.004 of an inch, but the majority showed no depression.

Machining a Deep Forming Die

The piece to be produced is shown in two views in Fig. 42. The only material fit for it was a good steel-casting or a drop-forging, and the steel-casting people said, "Not less than

ninety days, or four months after we receive the patterns," and the drop-forge people said, "A set of drop-dies for that will cost \$\$, and we are now four weeks behind in our die department."

Almost if not quite by accident a lot of drop-forgings like Fig. 43 were located; these were circular if looked at the other

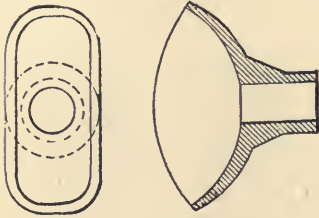

FIG. 42.—Forging to be made.

way. One of these forgings was bent or flattened to about the required shape by the blacksmith and compared with what was wanted, and as it nearly filled the bill it was decided to make a die and form them to shape, rather than wait for correct drop-forgings or steel-castings; and then

it was up to the shop to produce the goods.

At first it looked as though it would be a case of digging a cavity out of the solid steel, but the die-maker rebelled, as there was not much machine shaping of the die that could be done when made in the solid. Neither did he wish to make a "force" and heat up the die, put the two under the drop-hammer and hub the cavity to the proper shape. One reason being that their drop weighed only 190 pounds with a two-foot drop; besides that, it would involve quite an expense to hold and apply the "force." It finally occurred to the die-man that by taking two pieces and putting the two top faces of them together, boring a cavity in the face of the two pieces to a depth equal to one-half of the width of the required opening, then placing the two pieces face to face the other way, he would have a cavity of practically the required shape.

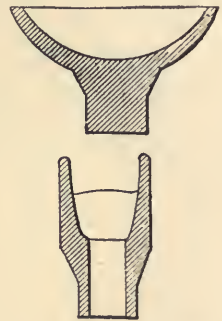

FIG. 43.—Forging commenced with.

Before doing the act in steel, he took a piece of pine in the wood lathe and turned it out to a nominal diameter, depth,

and shape, sawed the piece in two along line *AB*, Fig. 44, placed the two faces *C* and *D* together, and so had an ocular demonstration that his mental picture was correct.

He then got out the steel for the die and plunger, also a pattern for the holder, and had a casting made. After the die

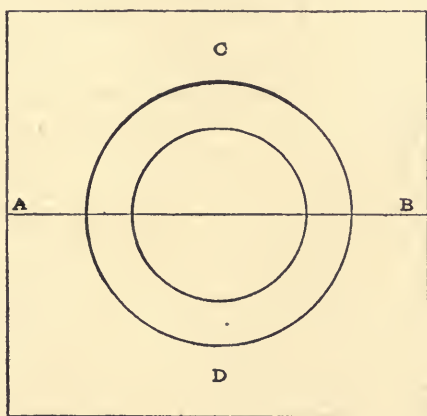

FIG. 44.—Method of die-making.

was bored out it almost looked like Fig. 44. The steel was next sawed in half at *AB*, Fig. 44, and in Fig. 45 as in the section, one-half only being shown. The two halves were next placed in the die-holder, centered up on the face-

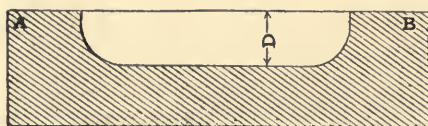

FIG. 45.—Cross-section of Fig. 44.

plate of the lathe, and the hole through the bottom was bored. This hole was the same shape and size as the outside of the forging.

The top face of the die was also concaved, as shown at *a*, Fig. 46, so that the forging would have a good seat, with the forging resting in the die and the upper former ready to do

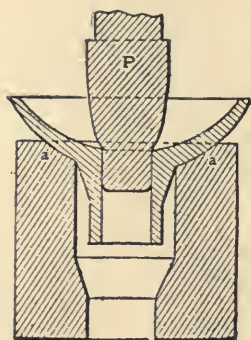

FIG. 46.—Die showing concaved face.

the forming. Fig. 46 is a cross-section on center line *C D*, Fig. 47. Fig. 49 is a corresponding section of the top former. The forging came solid, like Fig. 43, and was drilled as in Fig. 42 before being formed. The die-holder is strengthened by the two large bolts shown at Fig. 47. A positive knock-out, not shown, was used to clear the die.

As will be seen, the machine work on the die was lathe and shaper work, and that of the easiest kind.

Dies for Finishing Bossed Levers. Sectional Dies.

Dies of sectional form would include a boss only, on a lever, Figs. 50 and 51; the lever ends standing out beyond

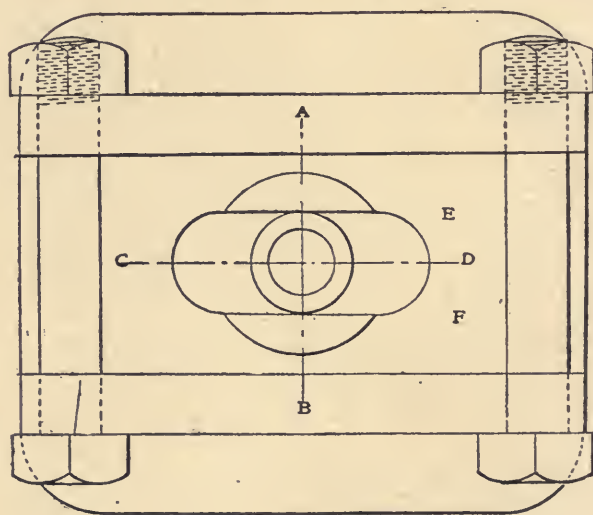

FIG. 47.—Plan of die-face.

the dies; or a die would be used to punch a hole, and correct a boss at the same time, Fig. 52. Lever ends, either forked

or solid, are suitable objects for finishing in this way. So are the ends of connecting-rods, Fig. 53, the eyes of tie-rods, and the bridles or loops of slide-valves. In the old practise, as to a large extent now, these were made of wrought iron, bent and welded.

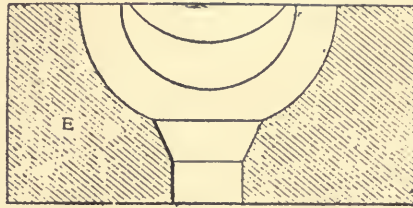

FIG. 48.—Section of complete die.

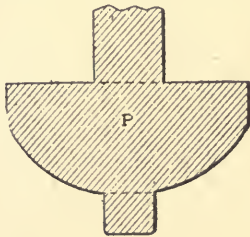
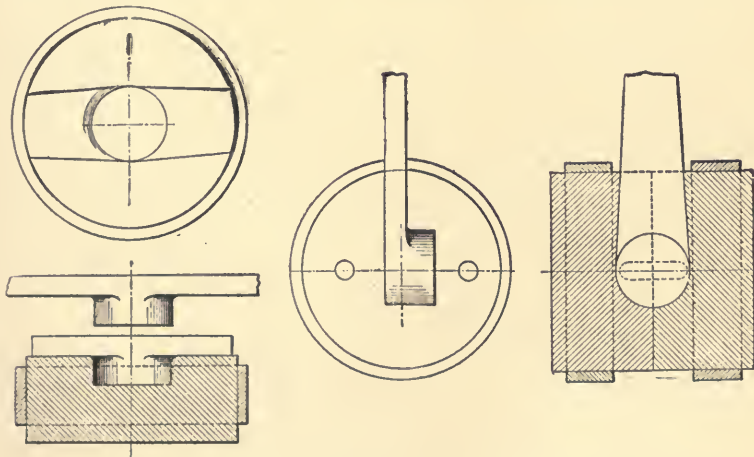

FIG. 49.—Section of upper former.

These operations were done at the anvil, and the correction and finish done at another heat in dies. These dies were and are made of cast iron from a pattern. Later, cast steel has often been used with a view either to increase the strength or to lessen the weight of the dies.

Even on the anvil, in little shops where there was not as yet a steam-hammer, the sledge was utilized in finishing the heads of bolts in dies. And on the anvil little devices were rigged up for finishing bosses and punching



FIGS. 50 and 51.—Sectional dies for bossed levers

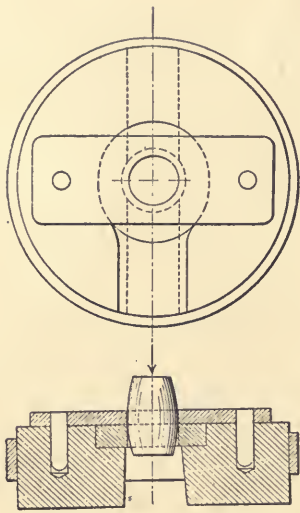

FIG. 52.—Correcting die.

holes, a type of which is the spring swedge, Fig. 54, the jaws of which were fashioned independently of aid from the machine-shop, by a process of typing or hubbing from a dummy or duplicate forging. Very many simple forms can be made, and are made still in this way, as a legitimate and suitable method. Light swedges are used on the anvil, just as the heavier ones are operated under the steam or drop hammer.

The sectional dies are used very extensively now in the blacksmith-shop for the purpose of final

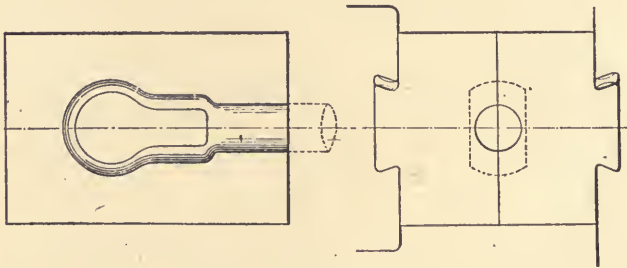

FIG. 53.—Finishing connecting-rod ends.

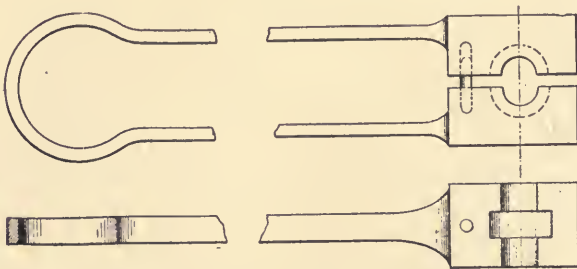

FIG. 54.—Spring wedge for forging.

correction and finishing only. But along with the use of these, there has grown the practise of drop-forging only, either

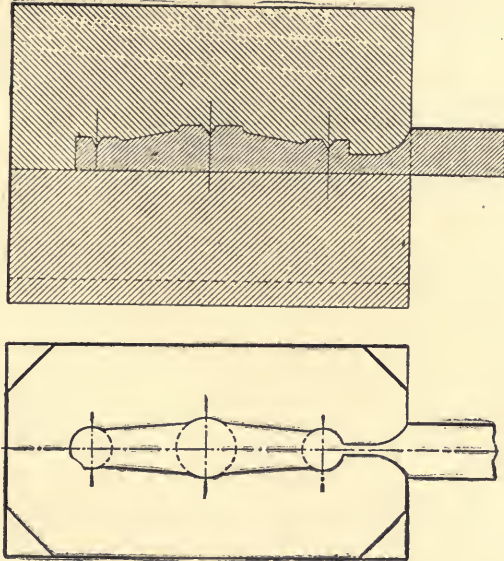

FIG. 55.—Example of forging-die, forming center holes in the bosses of the work.

as a sub-department of the shop or carried on in a distant shop. Generally, however, the merely finishing dies are used for the heavier forgings, and the regular dies for the smaller class of work, as shown in Figs. 55 to 59. To make the larger forgings entirely by forging operations would often require more heavier hammers and other appliances than most shops are equipped with, and the numbers wanted of the large forgings might not be sufficient to render heavier installation profitable. But a heavy forging may be finished in dies when it would not

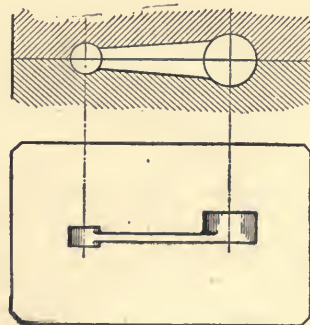

FIG. 56.—Dies for a lever with hubs at both ends.

be practicable to produce it entirely from a rude lump. Among work of this kind may be instanced large tie-rod eyes, large bossed levers, Fig. 50, rings, pillars, and such like.



FIG. 57.—Dies for forging an eye-bolt.

Some of these are too long to be embraced in a single die. A long two or three bossed lever, for instance, is then finished only on its bosses, and for an inch or two away from them. A pillar for hand-railing would have its bossed portions finished separately, and the body corrected by swaging at the anvil, or in other dies.

Materials Used for Dies

The number of similar castings required is often insufficient to justify a large outlay for cut-steel dies. But dies made in cast iron are not costly, and therefore they are frequently made when only half a dozen or a dozen of similar articles are required.

They may, of course, be kept for future use, and should be, when a job is likely to be repeated; but, apart from that, a very small number of forgings will pay the cost of cast dies.

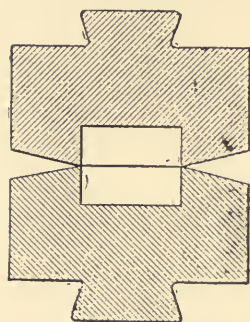

FIG. 59.—Dies provided with space for receiving the fin.

The growth of the drop-forging and stamping art has been gradual and natural. The mere fact of having cast dies lying by from previous jobs has been the cause of their utilization for pieces of work which might not otherwise have been thought to justify the expense of new dies. But being in stock, slight and unimportant changes in some dimensions in new jobs would often render the dies available. In this way the be-



FIG. 58.—Dies for finishing the eye-bolt.

ginnings of standardization arose. For as the dies began to accumulate, one pair or set was made to do duty for work for which it was not originally intended. Thus, the difference of half a ton or a ton of crane power was not allowed to involve the making of minute differences in the forged work for the cranes, but one standard set was used for both. So in the engine and pump work the same standard sets came into use for powers and sizes of mechanisms that were not dissimilar, and

when the difference of $\frac{1}{8}$ inch, or so, in dimensions could make no possible difference in the proper operation or strength of the forged parts or details.



FIG. 61.—
Forging
made
in dies
from a
bar.

*Principles of Drop-Forging and Stamping
Large Parts*

Comparatively few articles can be produced in one pair of dies, and those are chiefly circular forms, the diameters of which at different sections do not vary greatly. If they do vary, some preliminary operation or breaking down is necessary.

And if a portion of the article takes the form of an eye, or a boss, three or four successive operations may be necessary to produce the forging, as in the

eye-bolt produced in Figs. 57 and 58. The die-maker has then to settle how the work shall be done, whether in one or more pairs of dies, and whether under one hammer or two. As a rule, to which there are exceptions, it is desirable to do all work at a single heat. Then, if several operations are

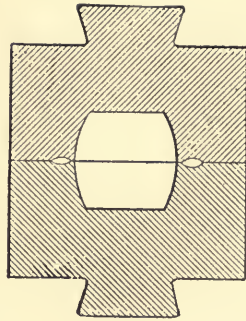

FIG. 60.—Dies with
space for receiving
the fin.

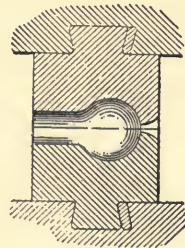

FIG. 62.—Die
for forming
the end of a
ball crank.

required they must be done either in one set of dies, or in separate dies. For small forgings it is easy to get three or four recesses in one pair of dies, for roughing down, for formation, and for cutting off or nicking for breaking off. In larger pieces it is necessary to have two hammers adjacent, so that the stamper can use them both without walking away from either. But a few hammers are made double headed, with two

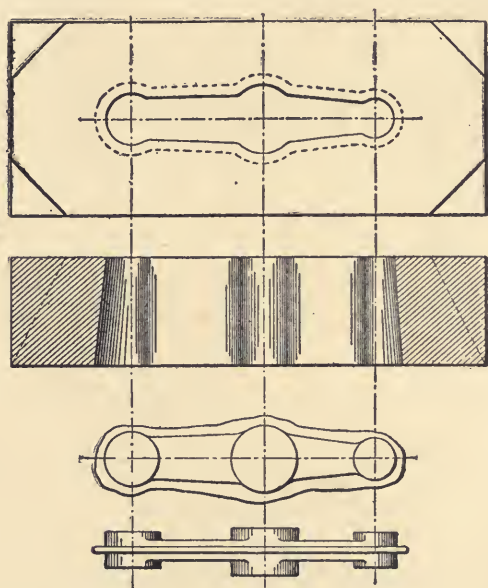

FIG. 63.—Stripping-die for removing fin and its work.

anvils, and tubs to facilitate such work. When two heats are necessary, then it may be convenient to perform the earlier operations on a large number of similar pieces, and then change the dies for the subsequent operation. This, perhaps, is more often done in the regular machine-shops than in the drop-forging shops, in which the work is divided between two adjacent hammers.

Though the smith working at the anvil endeavors to gage by a very rough metal estimation the amount of material which is required for a forging, in order to lessen the labor, the

drop-hammer man may be comparatively indifferent to that consideration. He will not, of course, have much excess of metal if it can be avoided, yet he is much in the same position as the anvil smith who has a steam or drop hammer available adjacent to his anvil. The power-hammer is often resorted to for roughing down an odd lump quickly, in place of taking a smaller section, which would require the alternative of upsetting, or of welding. The shapeless lump is simply roughed down rapidly in far less time than would be occupied in fullering on the anvil, or in performing the alternative operations of upsetting or welding. In this way, too, very many odds and ends, cropped from iron and steel bars, are utilized, which would otherwise go to swell the scrap-heap.

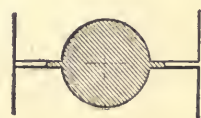

FIG. 64.

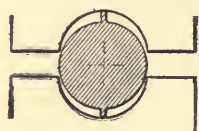

FIG. 65

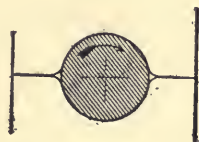

FIG. 66.

Showing how fin on round work is forged into bar by rotating it.

The case of hot stamping and drop-forging is analogous. Though forgings having considerable differences in cross-sectional areas, are, as a general rule, broken down in one or more operations, preliminary to finishing, yet a great deal of work is done without this step-by-step process. A cubical lump is taken and put into the dies and reduced. A large amount of the fin being squeezed out in the process, this is removed in an adjacent stripping-die, Fig. 61, and the forging put back and finished in the first, or in another, recess, followed sometimes by a final trimming. This heavy reduction is only possible in drop-dies, first, because the lump is raised to a high heat and the mechanical work done on it maintains the heat until the reduction is completed. At the anvil two or three heats would often be required to accomplish the same amount of work which is done in one heat in dies.

Removal of Fin Produced in Drop-Forging

The formation of fin, it will be noted, is peculiar to forgings; it does not occur in anvil-work. Sometimes dies are cut like Figs. 59 and 60 to receive fins. In Fig. 60 a wide and shallow groove is cut all around the recess to receive the fin. In Fig. 59 the faces are sloped away with the same object. Work which is of cylindrical form does not necessarily involve the formation of permanent fin, because it can be rotated, as the reduction is going on, and such excess of metal which is squeezed out laterally is removed at once when a partial rotation is given to the piece, as in Figs. 64 and 65. In Fig. 64 the fin is shown squeezed out; in Fig. 65 it is

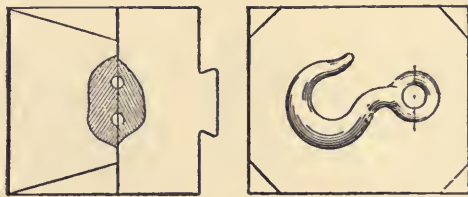

FIG. 67.—Dies for crane hook.

being driven into the forging again. Such being the case, Fig. 66 is the shape given to the circular dies in cases where the circular form is not hampered by the proximity of shapes which would interfere with rotation. When the work can be rotated, the result is a fine smooth, polished surface, which in many classes of work renders any subsequent machining unnecessary, or, if finish is essential, a little grinding may suffice. In some forgings a portion only, a stem or shank, can be so treated, the remainder consisting of an eye, or a flattened portion, or a square shape.

Difference Between Treatment of Steel and Wrought Iron

In the blacksmith-shop, wrought iron is still used as extensively as steel for small forgings. But many forms when made of wrought iron must not be forged from a solid lump,

because of the loss of strength which occurs across the grain. Large thin rings and curves of light section should always be bent. But if these are made of steel, no such reason as this exists, because steel has practically no difference in strength with or across the direction of rolling. The partial substitution of steel for wrought iron has therefore been favorable to

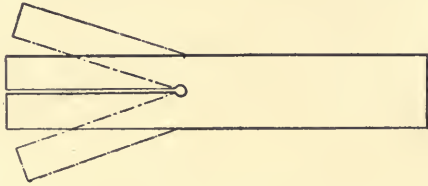

FIG. 68.—Bar from which Fig. 69 is made.

the development of drop-forging. Many jobs are now forged from a solid bar, or lump of steel, which were formerly made from wrought iron by bending and welding. Hence, while wrought iron is still extensively used for anvil-made forgings, steel is employed much more for drop-forgings. The crane hook, Fig. 67, when made of wrought iron, is always bent from bar before being finished in the dies. Made from steel, it is forged from a solid lump. For the forged end, Fig. 68, if made of wrought iron, a bar is slit and opened out, then bent over a form, and finished in dies. When made from steel, it may be forged from one solid piece. The flange, Fig. 64, is forged in steel from a solid chunk, handled by a porter bar temporarily.

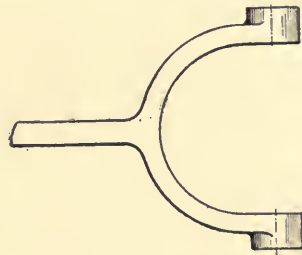

FIG. 69.—Fork lever.

Work with Holes Flanged Through It

The old method of punching holes is that shown in Fig. 52, in which the punch is guided by a plate doweled on the body of the die. This is suitable for large holes. Frequently, for small holes, the punch is separate and is driven through a

hole in the upper die, as in Fig. 70; in Fig. 71, a hole without its punch is shown. But punches are also often included solidly in the die, as in Fig. 74, half in top and half in

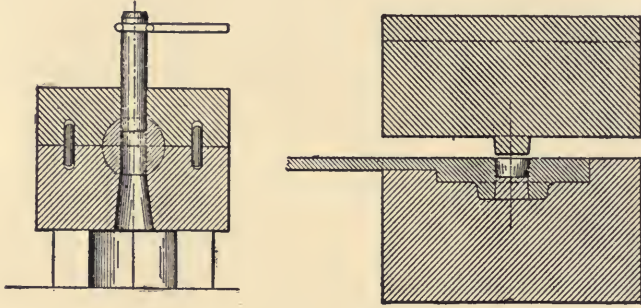

FIG. 70.—Punching small hole through work in dies.

bottom, and not quite meeting at the center. In a shallow boss the punch may be in one half of the die only, as for a forging like Fig. 72. The metal becomes squeezed into the boss and becomes improved through consolidation. Often,

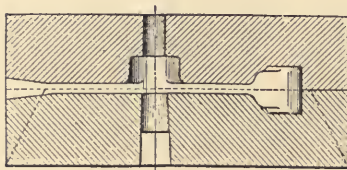

FIG. 71.—Punching holes through bosses.

when holes are left to be drilled, the centers are stamped by small conical projections in the dies which serve as accurate guides to the driller. Sometimes holes are punched only through a portion of the metal, Fig. 73,

when the central part has to be bored out subsequently, as indicated by the dotted lines.

Methods of Applying Impact or Pressure on Dies

Formerly all die work was done with hammer blows. As the demand grew for an extension of the system to heavier forgings, and to articles involving the bending of plates and sheets, the steam and drop hammers were not able to deal well



FIG. 72.—Holes punched by punches integral with die.

with these. The demand was met by the forging machines, which are actuated by hydraulic power or by gears, cranks, and toggle levers. These will easily deal with dies and articles several feet in length, many of which are too intricate to be

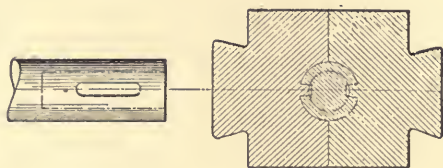

FIG. 73.—Semi-punching holes.

dealt with by hammers, even if their diameters did not set a limit to such treatment. They are practicable on the hydraulic presses, because two rams can be utilized, one acting in the vertical, the other in the horizontal position, so working at right angles with each other. This is utilized for bending,

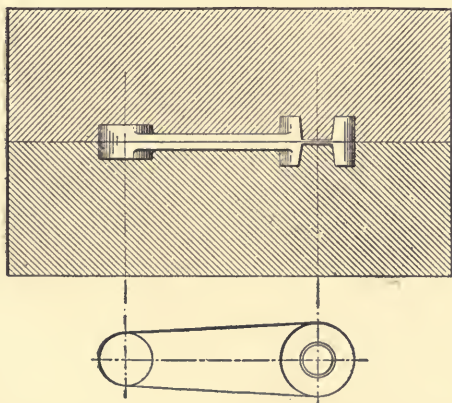

FIG. 74.—Construction of die for forging a hole through a boss

welding, and punching, for closing up joints, for dealing with undercut designs, and with hollow spaces formed by bending and welding or by forging. Typical of much work of this class is the die and punch used for forging the rings for uptakes of vertical boilers, Fig. 75, from a plain piece of steel plate. Fig. 76 shows the die for forging a crank by pressure.

A large amount of work of this kind is done in the railway-car shops.

Stamped forgings, or drop-forgings, thus diverge into two great groups, according as they are produced by hammer or by gradual pressure. Broadly, the first group includes articles of small and medium dimensions, the latter of a massive character, and all large work done in plates. This is now a generally accepted division, and one which harmonizes with the

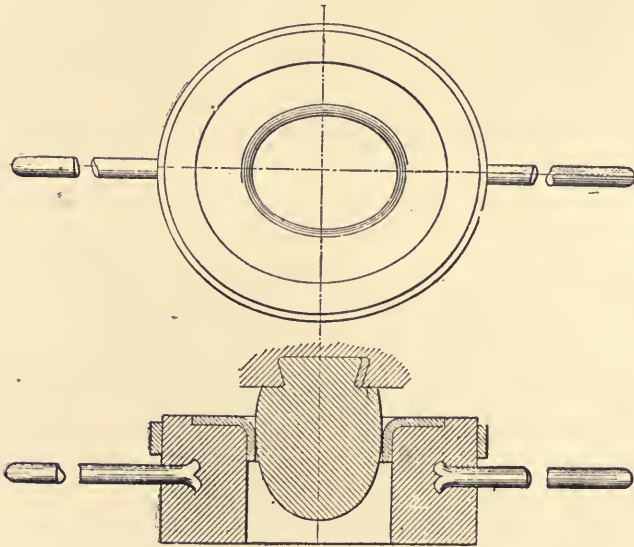

FIG. 75.—Die for forging and flanging man-hole seatings.

difference in hammer-blows delivered on comparatively small masses, and of pressure on thicker bodies. When mass is the condition present, slow pressure is more penetrating than impact, just as it is in large shafts and forgings. Moreover, the blows delivered from a very heavy hammer are destructive to dies, and if they are made massive enough to withstand these blows, then they are too heavy for convenient handling. Massive dies are, of course, required to resist pressure, but that is not nearly so destructive as the violent jarring action of the hammer.

Methods Used for Making Dies

The forces and dies used are as varied in their details and cost as the forgings themselves are. A great advantage of the forging machine dies is, that like machine molding, they are as readily adaptable to the demands for a very few identical articles, say ten or a dozen, as to hundreds or thousands. But the amount of work put into the dies, and the patterns and materials used for them have to bear a definite relation to the number of pieces required. Hence, we have at extremes, dies of cast iron made cheaply, and those of mild steel cut out with care and hardened. Except in name and function, the examples at each extreme have little in common. They are not made in the same way, and the periods of their service are much less in the first than in the second case.

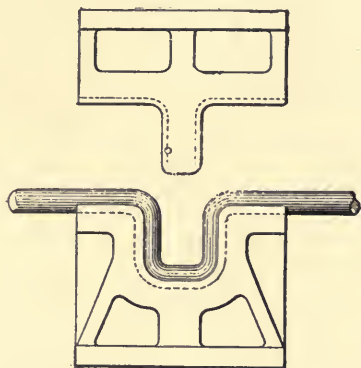

FIG. 76.—Die for forging-crank.

The cast dies are molded from suitable patterns. They may have to be cleaned up a little by the machinist, but no great amount of skill is required for this. As they are liable to fracture unless made massive, they are frequently encircled with bands of wrought iron, shrunk on, as in Fig. 52. They are, when small, lifted with circular tongs, Fig. 78, or by the hands, but larger dies have handles cast in for lifting them, Fig. 75. Or, alternatively, holes are cast for the insertion of rods for the same purpose. Some cast dies will endure long service, others fracture soon. Dies of cast steel are stronger, but are more liable to inaccuracy, because frequently they are not uniform in structure.

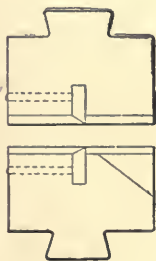

FIG. 77.
Cutters for nicking stock.

Marking and Working Out Dies

Dies of forged steel are marked out on their faces, and recessed by various machine tools, and by hand work. All the aids offered by machine and tools are utilized, as boring, slotting, milling, and shaping. But often very much of the work is left for the chisel and file to complete. There are several special machines designed wholly or chiefly for the use of die-sinkers, but much can be done by the ordinary tools in the shops. Templets are used to gage the progress of the work, including those of sheet metal for back sections, and those which represent the actual forgings, which have to be forged. These are made of lead, or tin, or a first sample forging is prepared. Contact is insured by the transference of red lead from the templet to the recesses which are being cut.

Typing or Hubbing Process

Reference has been made to the typing or hubbing process. It bears an essential resemblance to the operation of stamping

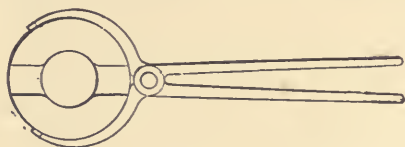

FIG. 78.—Tongs for holding dies.

medals and coins by a hard blow; only the operation is reversed, the die itself being produced by stamping it, while white hot, from a cold forging. It has the advantage of being cheaper than cutting dies, and in circular outlines is accurate enough, but it is not well suited for intricate shapes. The spring swedges are frequently made in this way. In obtaining circular shapes thus, the hub or type is rotated between each successive blow, so correcting any inaccuracies that might form. The edges are of necessity produced with a slight convexity, Fig. 66. But this is an advantage in producing circular forgings which are rotated in the dies. It is not

necessary to have complete circles in such a case, because metal squeezed out laterally, and what would soon form a fin, becomes obliterated by the next blow when the rotation into a new position takes place.

In one of the illustrations, Fig. 51, dowels are shown, which are inserted to serve as guides to secure the alignment of top and bottom dies. These are only used when the dies are not attached in any way to the anvil below and the hammer above, as is often the practise in heavy dies. But generally the dies are secured by dovetails and keys, as in Fig. 53. In some cases locating screws are used on the anvil for dies cut at the corners, like Fig. 67, and the dovetail is only on the top. The locating screws permit of making slight adjustments.

Forgings are often included wholly in their dies, especially in hydraulic forging-dies, and are knocked out by a knock-out device, or are pried out, or pushed out. Often a porter bar is used, generally the plain length of the bar from which the forgings are being made, as in Figs. 55 and 57. Then the forging is easily nicked by reducing the eye at the neck, as shown in Figs. 55 and 61; or a pair of cutters is fitted at the end of the dies, as in Fig. 77.

The contents of this chapter outline the methods of drop-forging in use, from which it is seen that the practise is divisible into three great groups: that done under hammers, and that in presses, and a further subdivision between the methods of the general shop and the drop-forgers who work for the trade.

CHAPTER II

DIE-SINKING AND EMBOSSING PRACTISE METHODS, PROCESSES, MACHINES, AND TOOLS

Making Forces for Embossed Work

THE process of die-sinking relates to the engraving or sinking of the female or lower dies, such as are used in the press-working of metals for jewelry, silverware, novelties, and forgings, and for producing raised lettering and ornamentation upon name-plates, tin boxes, pails, and similar work. The process of force-making relates to the making of the male or upper die to be used in connection with the lower die in stamping the metal.

With the exception of large shops where much embossed work is produced, there are few manufacturing concerns which employ die-sinkers, consequently embossing dies are usually sent out to a regular die-sinker, who engraves or sinks the lower die and returns it after hardening, his part being done.

Next, the force has to be made, and this cannot be done by the die-sinker in his little shop for two good reasons. First, in most cases he has no drop-press suitable to strike-up the force, and secondly, the force properly made should be struck up in the press in which the dies are to be worked. Consequently this work falls short of the die-sinker, and comes to the machinist or tool-maker in the shop using the die.

Properly Made Forces

Forces may properly be divided into two classes, those made of steel, and those made of copper. The easiest type of steel force to make is that which is termed a flat force, which should be used in cases where a flat back is wanted on the

embossed piece, or where extreme lightness is not desired. In such instances, a stronger piece is produced, but thicker stock must be used to make the work than it would be necessary to use where the regular style of force which follows the design of the die is used.

In cases where the design is fairly regular and not long and narrow in outline, the flat force is made by taking a piece of round tool-steel of about the same size of the largest dimensions of the outline of the design and about one-half longer. For example—a flat force for a design whose longest dimension is 2 inches, would require a piece of 2-inch round steel, 3 inches long. This piece of steel should be held in the chuck of a lathe and turned, egg shape or oval, on each end, and one end should be finished so that it is free from tool marks. Most of the drop-presses are fitted with a jack or “pick-up” die, such as is shown in Fig. 87, by means of which all except large forces are held. A flat block of hardened steel should be lined up central with this “pick-up” and firmly held there by means of the poppet screws on the press. The blank for the force should now be heated to a bright red and placed upon its finished end upon the lower die and then struck as hard as possible with the press; this will cause the force to embed itself in the “pick-up,” and it should now be rapidly struck enough times to spread it to the required size, then pried from the “pick-up,” hardened, and the temper drawn to a light straw color.

Different Shaped Forces

If a force is wanted which will carry the metal into the die and thus produce a thin light stamping, the same methods should be followed, except that in place of the block of hardened steel held on the bed of the press by the poppet screws, the lower die should be substituted, lined up and held as before. In making this style of force, care should be used to keep all scale from getting on the face of the die and spoiling the force. If the design of the die is deep, it may be necessary to use two or more heats, in which case the force should

be removed from the "pick-up" and reheated, then fitted into the lower die as rapidly as possible and at once struck. If done properly, it will lift with the pick-up and should now be struck until every detail of the die appears on the force.

When the shape of the outline is long and narrow, the steel blank should be of the diameter of the greatest width of the design, and about 1 inch longer than its length. The whole length of the piece should be finished smooth, as this piece, after heating, must be laid sideways on the die when striking it.

The reason for always leaving the most stock in the center of the force blank is that the center of the design is always the hardest to make "come up" sharp, consequently we leave the stock thickest there so as to help it all possible. Also a piece of this shape is easily "picked up," which would be almost impossible with a flat piece of steel.

Steel Forces for Flat Work

Steel forces for flat work, such as nameplates, tin-can work, etc., require very careful work, and while they can be made by the method already described, it is not the very best way, for the reason that the steel being struck into the die while hot shrinks upon cooling, and results in a force which will not fit the die as it should. This shrinkage is noticeable on all hot-struck forces, but matters little where there is any depth to the die. One method of overcoming this trouble is to strike the force in the die, after it has been brought up enough, every few minutes until the force has entirely cooled, but where the impressions in the die are so very shallow, like the letters on a name-plate, the corresponding letters on the force are very apt to be obliterated during this process, and so make the force useless.

By far the best way to make such forces is to start with a plain piece of steel whose face is the exact shape of the outline of the name-plate, and this should be beveled off toward the back of the piece about 10 degrees. The thickness of this

piece should be from 1 to 10 inches, according to the size of the name-plate.

This piece should now be given a thin coat of solder on its face, and then it should be carefully placed face down upon the die it is to fit, taking care that the outline of the force matches up with the design of the die. After placing both die and force under the drop-hammer it should be struck one solid blow, and only one. In doing this part of the work it is not necessary to fasten the force to the hammer of the press, but the die should be fastened to the press bed in the ordinary way. This being done, the force should be taken from



FIG. 79.—Embossed Police-shield before and after trimming.

the die, and it will be observed that the imprint of every letter of the die shows clearly upon the solder coating of the force, which must now be held in the vise while the solder and steel around the letters should be removed with small chisels until



FIG. 80.—Embossed badge before and after trimming.

only the letters are left standing. The force should now be fitted into the die and struck again, after which the solder on the tops of the letters may be filed off, leaving still a good impression on the steel force. The chipping process should be repeated and then struck again, until the background

has been sufficiently taken away. The back of the force may now be dovetailed so as to be keyed into the press, as the pick-up cannot be used with this method of force-making. In

some shops, forces are held to the head of the press by means of screws, but this is not good practise, as the constant shock and vibration of the press in operation tends to loosen them or snap them in two.

The chipping out of the forces can be greatly helped by using punches of various shapes; especially are these useful in driving down stock in the centers of the letters and other places hard to chip out.

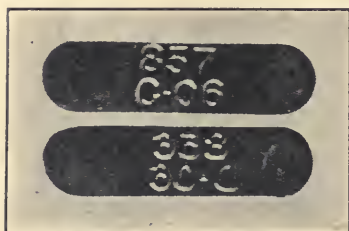

FIG. 81.—Embossed number plates.

Copper and Brass Forces

Copper forces do not require nearly as much care to make as steel forces, as they are always struck in the press. While it is often necessary to strike copper forces hot, they

can many times be made cold, which way is to be preferred, as the copper is much harder when struck cold, consequently the force lasts longer when in use. The stock for a copper force does not need to be round as it “comes up” when struck very easily. Copper forces are always held in the pick-up, and have the advantage that they may be struck into the die at any time while in use, and thus sharpen up the details of the design as they become worn.

In the absence of copper, brass is sometimes used for small forces, but it cannot be struck hot like copper, and it splits easily if struck too hard, and for these reasons is undesirable, though it can be used in an emergency.



FIG. 82.—Emblem and blank.

In the illustrations of embossed work, Figs. 79 to 86, some have been trimmed and some not. Figs. 79 and 80 illustrate german silver stampings for badges; Fig. 81 shows

a thin copper label struck up with a copper force; Fig. 82 is a copper ornament struck with a flat force, as will be seen in the reverse side illustration; Figs. 83 and 84 show examples

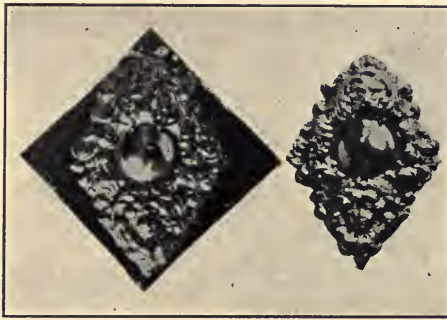

FIG. 83.—Embossed belt buckle in sheet-metal.

of stamped belt buckles; Fig. 85 is a name-plate of brass, made with a force which was made by the chipping process, as described, and Fig. 86 shows a heavy aluminum label made with a copper force. In the illustrations two cuts of each piece are shown, face and reverse views. Fig. 87 shows one style of pick-up die.

*Cutting the Impression in
Die-Sinking*

In the shop, employers judge of men's work by the amount they see, and, when all there is in sight to show what the die-sinker has been doing for several hours is a dotted line on a steel block, the employer is apt to have misgiving. Let him remember that "work well begun is half done." An old mover of houses once said: "When I've got a building well loaded on my rollers I allow that I've got the biggest part of the job done." When the profile of an impression is marked on the block of steel a good beginning has been made. The lines show

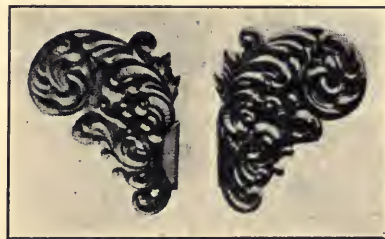

FIG. 84.—Embossed buckle.

what stock on the surface is to be removed; they do not show the depth to which they are to be cut away, nor the shape of the bottom. These are sometimes gaged, as the work progresses directly from the model; a better way is to



FIG. 85.—Embossed stamping.

mark off a side view on the side of the die, as it is very convenient to have it there in setting the drills to the right depth.

To illustrate the fundamental principles, these dies are supposed to be sunk with very simple tools, but not altogether with the simplest. It is fairly to be supposed that any place that requires dies has so simple a machine as a drill-press, at least.



FIG. 86.—Embossed stamping.

The simplest tools are those which a Frenchman proposed to use in 1861, when die-sinkers were in demand. He was an expert steel-stamp cutter whose experience had been exclusively on hand-work.

In applying for work at sinking dies he claimed, as a special inducement to give him employment, that he did not require any tools except a cold chisel and hammer. It was suggested to him that this accomplishment cut no figure when drill-presses

were abundantly provided and could displace stock more economically.

“No! no!” he exclaimed, giving his arm a swing as if to strike the blow of a Hercules. “I am strong. I cut a little place deep enough, then I set my chisel back just as much as I can cut, and I cut that chip to the bottom of the hole; then I take another chip; I am not lazy; then I take another—all just so deep—by and by, after a little while, I have the stock all cut out.”

The Frenchman’s theory was correct, perhaps, although our mechanics would probably cut channels through with a

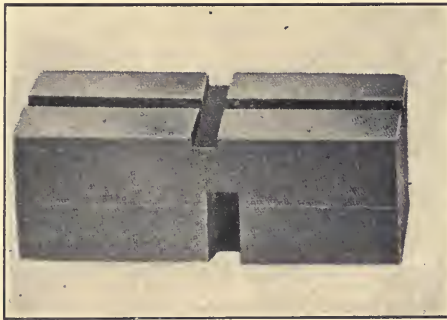

FIG. 87.—Force-holder.

cape chisel, and get rid of half the stock by breaking between the caping, provided they had to “knock a hole into that ere block with a chisel.” He made a first-class die-sinker, but he got bravely over his partiality for manual labor after experimenting with and experiencing the benefits of machinery.

Although most of the stock is to be drilled out, it will be necessary to do some chipping. A few stout bull chisels may be required for heavy cutting. A dozen or more chisels should be provided of various sizes and shapes. After becoming accustomed to them it will be found that it is very handy to use finishing chisels made of about $\frac{3}{8}$ -inch octagon steel, 7 or 8 inches long, tapered from about $2\frac{1}{2}$ to $\frac{1}{4}$ -inch for the size of the head, and from about an inch from that place tapered down to within half an inch of the point where it should

be little less than the size of the cut to which it widens at that point. They are conveniently kept in a tin can on the bench, points up. Some folks are so inherently mathematical that the rule of three dominates all their logic. They insist that if an inch chisel should be 8 inches long, then a quarter-inch chisel should be one-quarter as long—4 into 8 two times—hence a quarter-inch chisel should be two inches long. File cutters' chisels are short, but in die-sinking more free-hand work is advisable. If Fig. 90 is not a very good representation of the chisel described, do not lay all the blame upon the engraver.

“Breaking-through chisels” for bursting out the honey-comb left by the drill are stronger. They may be made of $\frac{5}{8}$ -



FIG. 88.



FIG. 89.



FIG. 90.

Die Sinkers' chisels.

inch octagon steel thinned down back from the point from an inch and a half to two inches, to a little less than the size of the drill which they are to follow. A very good shape is shown in Figs. 88 and 89. The use of these chisels in plowing furrows through the stalactic remains after drilling is apparent.

Before proceeding any farther it may be advisable to make trial templets, 1,2,3,4,5, shown in Fig. 91. Templets for trial are sometimes preferred made without the overhanging ends which are here shown, and are designed to rest on the surface of the block, to indicate the proper depth. When they are made without these ends the depth is indicated by a mark drawn across, or notches filed in the edges of the templets.

Adjustable depth-gages are also indispensable in die-sinking; they are made in a variety of forms, according to the taste or notion of the workman.

Riffles and Their Use

Some die-sinkers provide themselves with peculiar shaped pieces to fit into the places in the dies which they want to smooth up. On those they cut teeth, and as they are provided with shanks for handles they can be used for smoothing, like files.

These tools are called "riffles," and to-day may be purchased all ready finished in a variety of shapes and sizes, both smooth and coarse cut. Other die-sinkers do this class of work with scrapers. To get a purchase to brace against in scraping, they use a rod which they support with the left hand. They thus avoid injury which the bracing of the scraper might inflict upon the edges of the die. The edges are sometimes protected for this purpose by interposition of a strip of copper or zinc.

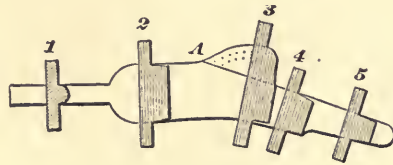

FIG. 91.—Trial templets.



FIGS. 92 and 93.—
Drilling die.

The stock which is to be removed from the impression to correspond with the depth templet (1) Fig. 91, is semi-circular. It could be bored out either on a drill-press or in a lathe. In this case that is not the best way. It is better to drill it out, as shown by Figs. 92 and 93. We therefore lay out a central line lengthwise through this part of the die, and draw two series of lines across it in an angle of 60 degrees, which intersect each other and the central line at distances which are a little greater than the size of drill which we decide to use.

The points of the intersection are then punched, for they are all the centers of the holes which are to be drilled. The drill is set as near as may be to the proper depth marked on

the side of the die, and a stop on the drill-press is adjusted to gage it. The lost motion should be taken up out of the drill-spindle. Ordinary care must be exercised not to drill too deep and to keep within limits, sideways, as any excess in any direction will necessitate planing off the dies.

Drilling Out the Stock

The form of the impression at the end of the large part, gaged by templet (2) suggests that if the die was strapped on the face-plate of a lathe in the proper position, the impression might easily be formed with a turning tool, or that it might be readily made on the drill-press with a boring tool like a counterbore or end milling cutter; and the half round shape of the other and smaller end of the impression suggests that the same means might be adopted to sink that also, and there being so much of this kind of work to do on the dies, it would be economical to make a lathe job of it, and so they might be sent to the lathe. The proposition is very tempting, and under favorable circumstances might be accepted, but really it is not any more difficult to make these parts of the die by drilling and chipping than it would be if their form were not so well adapted to be made by boring or turning, and the trouble of making arrangements for doing it in the lathe or special tools for boring it in the drill press might not be compensated for by increased facility or perfection. We will therefore lay it out and drill it as we did the first part. We will lay out and drill at this time all of the die which is to be sunk to a uniform depth. Afterward we will lay out a row of holes at the proper distance from the edge of the rounded part of the die which is to be sunk to templet (3). This rounded part starts in at *A* and runs to the dotted line shown through the templet, and setting the drill to the depth near *A* it can be kept at that depth at an equal distance from the profile line around to the dotted line, and then a new series of holes of a different depth from these, but uniform with each other, can be drilled on a parallel line with these, and so on until this section, which has a bottom of unequal depth, has been duly drilled.

Using the Breaking-Out Chisel

The work of the breaking out chisel is now in order, and the labor of five minutes at this stage of the proceedings makes a better show than at any other time. The honeycomb is quickly knocked out and a ragged-looking hole appears. Giving the edges a skelp all around reduces the profile to smoothness and prepares the way for the really good work on the die to commence. This consists in cutting the upper part exactly to the profile, as delineated on the surface; in following down from the surface outline at the exact angle which has been determined upon for the draft in getting the bottom of the proper shape, and in getting the corners, where the sides meet the bottom, into true and regular form. These things are all really difficult to do with a chisel, while with a cutting tool—a revolving cutter—they are done with but little trouble, as they are largely governed by the shape of the tools employed.

If the chisel is not properly used an excessive amount of time will be required to finish up with the scraper. It is astonishing how fast a mechanic improves in close chipping by practise, but it need not be, when we reflect that a good deal of ornamental designs and engraving is done by foreign workmen, mostly with tools which they impel with light hammers.

Good sharp chisels can only be kept sharp by having them made of the best material, so they will stand to be left hard enough not to lose their edge by battenning. To do close chipping requires an edge that is keen, and that will remain so—one that will not sink away from its grip, but will carry the chip clear through.

In finishing up the lower corners, some die-sinkers make use of sets, which are shaped so that one side of the working end rests on the flat bottom of the die, and the other rises up at the proper angle to give the right inclination to the side. These tools should not be used to such an extent as to cause unequal tension in the die by driving stock down with aught to have been cut away.

“Roughing tools” are useful in bottoming; they are made on a matrix which is simply a mass of square points. By driving the hot roughing tool down on this the end is formed, as though it was a dozen chisel edges crossed with another dozen chisel edges. It is afterward hardened. By driving it down and moving it about it stamps fine checks, and these are easily rubbed away with file or scraper, leaving a smooth surface.

When the dies are nearly completed, ready for the final finishing, arrangements are made by which a lead cast be taken when the dies are clamped together, as they are to go. If the edges as shown by the lead cast do not correspond they must be altered in the dies until they perfectly match.

The Champney Die-Sinking Process

Many of us know what die-sinking is and what it costs; we are all familiar with the clean, light shop, with its planers and shapers and drilling machines and its rows of die-sinking machines, all beautiful tools; and its row of clean, bright, intelligent workmen sitting in a north light, industriously and with concentrated attention slowly sinking the shape of some piece of work down into the solid metal of a steel block, with their queer shaped files and delicate chisels; most of us have looked at a finished job of die-sinking—an absolutely perfect fit for the irregular surfaces of the piece which it is to make, and have secretly wondered at the skill of the workman who could do such a job. Some of us have seen a marvelously constructed pantagraph tracing its thousands of cuts in a coin-die, guided by a large model which its mechanism reproduces in reversed miniature in the block of steel to be used in the coining press, and we have also admired and wondered at this beautifully exact piece of high grade mechanism, and of course we know a lot about die-sinking; we know what machines must be used, what class of workmen—really artists the good die-sinkers must be—what grades of steel, and above all what days and weeks of patient labor must be used to make a finished die. We know it to-day, just as we knew it twenty years ago; die-sinking by the old-established methods can be seen

in almost every good establishment in the metal manufacturing trade; the use of the drop-hammer and the power press, mechanical or hydraulic, in metal manufacturing, the old, slow, skilful, well-established methods; and yet George F. Champney, engineer, found out thirty-five years ago how he could make any die for any purpose, from the heaviest forging die to be used under the most ponderous drop, to the finest medallion or coining die, in one instant—in the very briefest fraction of a second, with the simple, almost rude tools shown in these engravings; and not only found out how to sink dies perfect in shape and surface, but far superior in quality and endurance to any dies made by any other method.

History and Evolution of the Process

Fifteen years ago a gentleman, knowing that another was as one of the Athenians, who held that day lost in which they learn no new thing said: "There is a man in Bridgeport, Conn., who has a hammer with a 50-foot drop; he takes a cast-iron force any shape he wants, and fastens it on the bottom of this 50-foot fall hammer, and he puts a block of red hot steel on the anvil of that hammer with the force on the hammer, and just drops the hammer with the force on the bottom of it right down into the steel at one spat, and it makes a perfect die in the steel and don't hurt the cast-iron force at all—doesn't even mark it—you could not tell by the looks of the cast-iron force that it ever had been near a piece of steel, much less been driven bodily into the solid metal, so as to produce its exact and perfect reverse in the block, and make a perfect block in which to produce its own shape."

The other man said to this gentleman that it did not seem possible such things could be; that he should think the cast-iron image or force would be crushed to atoms, and the hot steel block on the anvil would spread out, so that the result of the 50-foot drop of the hammer would be a couple of ruins—a ruined force and a ruined die-block, instead of an instantaneously made, absolutely perfect die, and an uninjured force.

To this his informant replied that he himself would have

thought the same thing, but that what did result was a perfect die, exactly reproducing in reverse every detail of the piece put on the bottom of the hammer.

The seeker after new things went to Bridgeport and asked at E. P. Bullard's machine tool works if there was a man in Bridgeport who was making a drop-die by dropping a big hammer 50 feet, with the force on the bottom of the hammer, into a block of hot steel, and making a perfect die at one blow. This question was met with a smile and the reply, "Not that we ever heard of." I said: "You would be likely to know if such a thing was being done?"

"Very likely indeed," was the reply. A search in the directory disclosed the name of "The Patent Die Co.," 88 Cannon Street, and at 88 Cannon Street Mr. Champney was found, and with a drop of 52 feet, and a lot of die-sinkers, and a vast number of the most beautiful specimens of the dies conceivable, and an order-book full of orders from such firms as the Gorham Company.

Thirty-five years ago the idea struck Mr. Champney that at a suitable velocity a cast-iron medal, or even a gold or silver coin, could be driven bodily into a block of hot steel, so as to produce a perfect die in which its own shape could be duplicated by use of the coining press. Experiments convinced him of the truth of his theory. He went to Europe with this invention, and remained abroad for ten or twelve years, in close connection, for a part of the time, with the Russian Mint, where he made dies which gave from 30 to 70,000 impressions, as against 6,200 impressions for the life of any die there made by the ordinary methods for the same piece, and was decorated by the Emperor with the order of Stanislaus for his invention. After these years in Europe, Mr. Champney returned to America, and proceeded to perfect his methods so as to make them applicable to dies of all sizes; his previous work had been for coining purposes and medals only. He started to work in Bridgeport, where he made many dies for leading firms of silversmiths and metal workers all over the United States.

His original idea was simplicity itself—given a model for a piece of work to be produced in dies, the simplest method possible is, of course, to drive that model into a block of steel, so as to leave its perfect image in the soft block; then take the model out of the die and harden the die, and there it is. As is usual, between the happy thought and its happy realization, lay a waste of dreary desert years, the story of which Mr. Champney will not have printed. The old story, no doubt, of shining moments of success, buried in speedily following failures; partial gains which could not be made entire and complete, and total disasters which could not conquer Champney's faith in his theories; finally, in Bridgeport there came to be a small establishment doing good work, patronized by the best manufacturers in the country, and possibly the nucleus of a large and prosperous business for the closing years of Mr. Champney's life.

Modeling, Casting, and Dropping

The method practised at the Bridgeport shops in the beginning, which was fifteen years ago, in producing a hardened steel die from model, was this: The model, a bit of wax shaped to the designer's fancy, and mounted on a block of wood, a medal, a coin, a plaster cast of any object, a natural leaf from a tree, anything in short from which a plaster cast could be taken, could have a die made from it which was not an approximate reversed copy, but was absolutely perfect in its reproduction; every line, every elevation, and every depression of the model were made in thousands of duplications from the dies, which were mechanically copied from the models by Champney's processes.

First, if the article was not suitable for use as a pattern to be molded in sand, a plaster cast for use as a pattern was taken from it, and in this plaster cast, as a mold, a second plaster cast was made which was a duplicate in form of the article to be reproduced. Next, this last cast was molded in fine Troy foundry sand, the same as any piece of fine iron casting. This sand mold was faced by smoking and printing the pattern

back in the mold until the surface of the finely divided carbon facing, deposited by the smoking process, gave an absolutely perfect mold of the model. Then this mold was poured with Barnum & Richardson's car-wheel iron—just a good, strong foundry iron, nothing secret or special about it. Mr. Champney made the molds himself, and he also poured them, melting his iron in plumbago crucibles, and with a coke fire in the furnace shown in Fig. 94. New crucibles are to be seen standing on top of the brickwork of the furnace, and one



FIG. 94.—Forge where dies were heated.

which has been used is standing on the floor by its side. The furnace was a plain, iron-banded, brick-work affair, with an ordinary grate of square bars, loose fire-brick doors, and an ash-pit, all of the most common construction. At the beginning of this Mr. Champney was neither a die-sinker, nor an iron molder, nor a steel temperer. But he became all three, and his iron molding came very near perfection. He showed at that time a cast in gray iron of a large medallion which was absolutely perfect, and appeared to have been carefully and beautifully finished all over, but had really never been touched since leaving the sand; another, a "waster," not good enough

for Mr. Champney's requirement, is reproduced in Fig. 97. A steel die had been made from it, but it did not bear anywhere the smallest mark of service. The quality of Champney's good founding may be guessed from the appearance of the surface of Fig. 97, photographed from the "waster" mentioned. The force, or cast-iron reproduction of the model was made with an added base, about $\frac{1}{8}$ of an inch thick, as shown in Fig. 97, which is full size; this base is faced on the bottom so as to lie flat and firm against the bottom of the

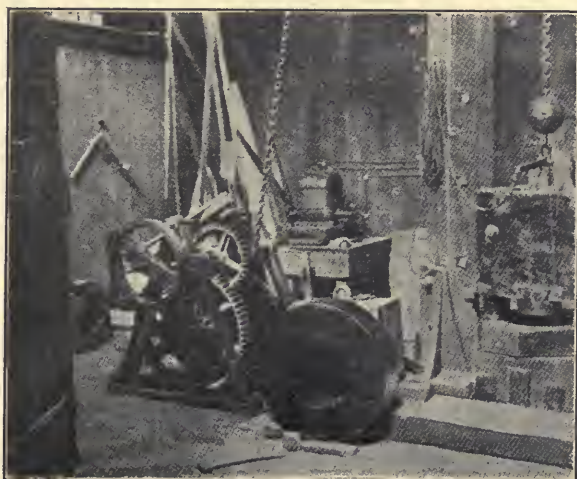

FIG. 95.—Drop-hammer for sinking-dies.

hammer where it is secured, but by means not shown, while the hammer was lifted and fell to make the impression in the die, or was driven at the Bridgeport Patent Steel Die Company's shops.

Driving Model into the Die

The block of steel into which the model was to be driven was not hollowed out or shaped in anyway so as to partially conform to the general outline of the "force." On the contrary, the face of the die-block was roughly crowned both ways in the shaper, so as to have a clean metal surface, without scale

or cinder; the crowning varied with the size of the block. It was quite high, perhaps $\frac{1}{2}$ inch in a block about 6 inches long by $3\frac{1}{2}$ inches wide. The dies were made about the common practise for thickness. After the force or model had been "driven" into the hot steel, the metal of the dies was raised up in a high border all around the base of the force, just as it would be if the force had been dropped into a mass of very wet clay, and this raised edge lay up tight against the edge of the base of force. The extreme lift of the hammer, 52 feet,



FIG. 96.—The die-sinkers.

was used only for the largest work; various drops of the hammer were used, according to the size of the die. The largest die made at that time by Mr. Champney, of which he could find a record, measured 12 inches by 10 inches for the top opening of the die, and was 8 inches deep from the finished surface of the die to the bottom, and the finished die weighed 212 pounds.

The hammer used by Mr. Champney weighed 1,500 pounds, and had an extension which could be keyed to its top, which weighed 1,000 pounds, thus making the greatest hammer weight available—2,500 pounds. With 50 feet of drop the

final velocity of the hammer would be considerably over 50 feet per second. This was reduced somewhat by the V-uprights which guided the hammer in its fall, so that the extreme velocity attainable was estimated at 50 feet per second. The hammer was lifted by a power-driven winch shown in Fig. 95; a portion of the hammer is also shown. The dimensions of the hammer-room did not permit placing the camera so as to take a single picture including all of both. The lift-



FIG. 97.—Specimen of work done.

ing chain was attached to the top of the hammer, and was released by the hand-line, seen coiled on the left upright of the hammer-guides.

These uprights are of wood, having cast-iron V-guides bolted to their inner faces. The bottom of the hammer had the usual dovetail and key for holding dies.

It was, of course, essential that the die-block should be perfectly confined sideways.

The steel used was "die steel," made by Farist, in Bridgeport. Any suitable steel might have been used, as there was nothing special about the steel.

Mr. Champney said the die-blocks were heated to "white" heat before being placed on the anvil for a "drive." The actual degrees of heat was not given. The heating was done in the furnace shown, as was also the heating for tempering.

After the driven block was cold it was planed in an ordinary shaper (the only machine tool in the place) and planed flat on the top down to the proper height, and was then passed to the die-sinkers, Fig. 96, who did what was needed in the way of finishing and "matting" to the working surfaces of the dies. If the force was absolutely perfect then the die need not have been touched by the die-sinkers, and was not.

A head of Rubens, from celluloid impression made in a Champney die, the surface of which was never touched by a hand tool, was of an absolutely perfect finish, as were a medallion head of Ariadne in copper, and a smaller medallion, also in copper. Both the head of Rubens, which was driven from a casting made from a plaster cast of a Brussels medallion, and the copper medals mentioned were of the most perfect surface conceivable, and all were struck in dies which had never been touched by a hand tool. But very many dies were made in the Bridgeport shops from models in wax, which were by no means perfect in detail; the petals of the flowers represented wanted sharpening at the edges, matted surfaces were left plain, and delicate lines were omitted entirely, to be put in by hand after the die was driven. As might be guessed, the very smallest and faintest marks on the original were reproduced with absolute fidelity in the Champney dies, and a die struck from a \$5 gold piece, with "Champney" in sunk letters, was absolutely faultless in every detail under the microscope, and the die of the "Head of Rubens" had a perfect polish in every detail.

Heating and Hardening of the Dies

The heating and driving of the dies under the hammer, and the hardening and tempering were all done by Mr. Champney himself. The heating for all purposes was done in the natural draught Lehigh coal furnace shown in Fig. 94, just as it appeared after a large die had been taken from it to

go to the hardening tub shown in Fig. 98. This tub was simply a barrel cut down to make the ends of a die holding grating at the sides, and notched still lower at the right for an overflow.

Two barrels on an overhead platform were filled with water from the small vertical supply pipe, and a much larger stream was piped from these barrels down to the hardening tub (cut down from a larger barrel) below. This large pipe had an upward bent open in the tub, something like 2 inches or 3 inches below a grating made of small wires crossing two bent round rods hooked over the sides of the barrel, all as shown in Fig. 21. The supply stream was small, and the barrels overhead were ample reservoirs.

Pure water only was used. The round wire rods were perhaps an inch or two below the water-line established by the overflow at the right. The flow in the large delivery pipe was regulated by the hand valve.

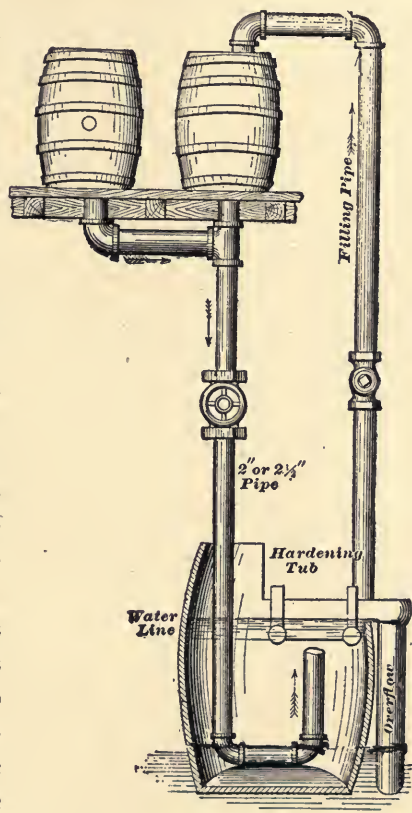

FIG. 98.—Hardening appliances.

In heating the die the face was not allowed to come in direct contact with the fire; bent pieces of sheet-iron were wired on the die so as to cover the sides, and an iron tray, considerably larger than the face of the die, was provided and filled with powdered charcoal or bone charcoal, as may be thought best. This tray was then put in the fire, and then the

die, having its sides and edges clothed with sheet-iron as described, was laid face down on the tray of charcoal; coal was added around the die, and the furnace door closed until the die was hot; then the die and tray were taken out, turned right side up, and the tray was then, and not until then, removed from the face of the die, thus keeping the die at all times full of the red hot charcoal or bone-dust. The die was put bottom down on the grating in the hardening tub; the stream was turned on against the bottom of the die until it was cooled about half way up, the hot charcoal still filling the cavity of the die, and perfectly protecting it from the air; the die was turned face down on the grating and the full stream of water turned on so as to rush up into the inside of the die and cool it as quickly as possible; the die was returned to the furnace immediately and drawn rapidly, after hardening; both heating and cooling were done as rapidly as possible. As an illustration of the value of a large stream of water delivered close to the face of the die, Mr. Champney said, that a die was brought to him from the Russell & Erwin Factory, New Britain, for half of a metal door-knob, an expensive piece of die-sinking, which they had tried three times to harden, and believed would not harden at all; this die Mr. Champney hardened so that no file in his place would touch it, at the first attempt, by the methods described. The Russell & Erwin shops had a tempering tub piped with an up-stream, but the nozzle was 18 inches or so below the grating which the die laid on, and hence the hardening stream was too much diffused, in Mr. Champney's opinion, to be effective.

Exactness of Size of Dies

The exactness of size of dies made by the Bridgeport shops was wonderful. One set made for exhibition from half of a common ball peen machinist's hammer cut in two in the middle lengthwise, was as perfect in everything as can be imagined. But Mr. Champney believed he could make dies considerably larger or smaller than the force, and could also make the die-disk crown more than the mode; thus he said he could

make the die driven from a gold piece $\frac{1}{8}$ or so larger or smaller in diameter than the model which drove the die, and could also raise or lower the center of the die at will, so as to increase or diminish the weight of the coin struck in the dies. He did not explain the means by which he could do this, but said the result was certain and as he wished, invariable, and he added that he had never lost or cracked a die in hardening.

Final Development of Champney Process

The full details of the Champney process have been secured since the foregoing was written, and were for a long time kept secret, and even to those who had a general idea of it the entire process was not very clear. However, I publish here the final development of the die-sinking practise:

If, for example, a die for striking up a deep hollow-ware bowl was to be made, Mr. Champney's plan was to first make a model of plaster of Paris. From this model a casting was made of the finest and closest grained iron obtainable, with a large amount of metal left behind the model for strength. The sand was then cleaned from the casting without removing the hard scale, which is an important feature of this process, and it was then keyed to the hammer of the high drop. This high drop was rightly named, for although it was of the usual drop-press design, the ways are eighty feet high, the lower parts of iron and the upper of wood, faced the whole length with steel. The hammer itself is of cast iron and weighs 3,200 pounds. It is about two feet square and three feet long, and is raised by a windlass operated by hand. A pull on the rope attached to the release-lever allows the huge weight to drop, and on the way a latch is fitted to catch the hammer on the rebound, for a double blow is fatal to the die.

To the base of this great drop-press, which was necessarily very heavy, is fitted a cast-iron ring, which is 3 feet in diameter and 10 inches thick. The opening in the center of this ring is square and large enough to take any ordinary size of die-blank. After keying the cast-iron hub (or type) into the hammer of the drop and raising it to a height judged by the

operator to be sufficient, the die-blank δ , which has been heated to a bright red, is placed within the square opening in the ring at the base of the press, and shims S placed around it so as to completely fill the space between the blank and the inside edge of the ring. The heavy hammer is then released, driving the hub with its facing of hard scale into the red-hot die-blank. As the displaced steel could not go sideways on account of the shims, it had to go upward and helped to bring the resulting impression up to shape. After being struck, the die was annealed and the scale removed by pickling; then enough was planed from the face to leave the die the proper depth, and by means of scrapers and rifflers the impression was smoothed and finished as in the ordinary methods of die-sinking. Next the die was "shanked" to the press in which it was to be used, and after hardening and polishing it was ready for use.

Die-Sinking Machines

One of the essential elements of a machine for sinking dies by cutting the stock out from the impression seems to be a slide-bed with two lateral movements at right angles to each other, and another is a revolving spindle perpendicular to the bed, with facilities for graduating the distance between the two. Other movements of nearly equal importance are sometimes incorporated with the machine. All are modified and adjusted for the purpose proposed, and every adjustment provided which will conduce to their proper employment. The gratifying result of the whole combination is a machine which is not duly appreciated, but which is constantly developing unlooked-for possibilities and capabilities. It is like a trade of which those who have worked at it the longest, and learned it the best, will say: "We are always finding out some new thing about it."

Die-sinking machines, as now made, are intended to be used, whenever occasion requires, as copying machines. They are so arranged that a model die may be fixed on the bed which carries the die to be formed, and hence these two dies will be moved in concert, holding at all times the same position

relative to each other. A place is provided in the head which carries the spindle for the insertion of a "guide-pin" which will hold a like relative position of the spindle, and thus if the "guide-pin" is kept in contact with the model die and made to follow all its depressions and outlines, a cutter fixed within the spindle and corresponding in shape and size to the guide-pin will remove from the other die whatever material is brought in its way, and produce on it an impression which will correspond to the model in every way and point touched by the guide-pin. The correspondence of the pin and cutter in shape and size is important, so that the shape shall be proper for the work. If there is any variation in their size, there will be a uniform but not a proportional difference of size in the impressions of the model and the made die.

As the arrangement of motions in this machine is such that it can present an object to the grubbing of a rotating cutter in every direction, horizontally as well as downways, and as the cutter will mill away and remove any stock so presented, it is evident that with properly constructed cutters it can produce work of any shape or contour, or of any sharpness of angle, except such inside angles as are consequent upon its horizontal motions. The acuteness of these, if produced by rotating cutter, is limited by the radius of the circle of the cutter, but if it is necessary or becomes expedient to cut such angles with the machine rather than to dress them out by the hand, a chisel may be substituted for the mill, and the stock from any corner may be removed with a light planing or splining cut, which does not strain the screws more than their ordinary employment. This application was especially provided for on the original "Index" of the universal milling-machine; the spindle and ball and socket connecting with a stout lever by which endwise motion could be obtained.

The quality of work which the die-sinking machine is intended to do requires that it should be made with such accuracy that will fashion work with undeviating precision. It is in fact so well made that with well-ground cutters the bottoming cut leaves a surface as smooth as though it had been

stoned. Parties have fitted the three actuating screws with micrometrical indices by which its actuating motions in any direction may be gaged and stated very minutely, and have so balanced its movable parts as to render it delicately sensitive to the touch. With these nice appointments, determinations, and susceptibilities, it is competent to as fine performance as the copying machine, noted in London almost one hundred and twenty years ago for its work in copying medallions, which must have had similar capacity of motion, and have substituted a fixed graver for a revolving cutter to have secured its finest effects.

These remarks about the die-sinking machines are not intended for those who know of it, but for those who know it not. It is a prompting of business instinct to seize upon the advantages to be derived from the employment of machinery as soon as they are shown to exist, with the same avidity and for the same reason that specks of gold are picked up whenever they can be found. So was the world's mass of gold gathered, and so individual wealth is accumulated.

Closed and Open Dies for Forgings

In most shops where drop-forging dies are used it will pay to use closed dies on some forgings, even when with good contrivance most of the work can be done with open dies. The difference between a closed die and an open die is this: In a closed die the stock cannot escape, but the overplus, or whatever is taken into the dies more than enough to fill them, is thrown out as a fin, and is removed afterward by trimming in a punch-press or with a chisel, or by grinding, but in open dies the stock is worked sideways successively until it is brought to the proper size and shape, and the overplus stock, if any, is worked out at the ends, and simply requires to be cut or broken off. It will be observed then that the open dies only require to have bottoms of the impressions made to the right profile because these only impress the form upon the stock, but in closed dies the impression must be correct on all sides, because the stock fills the die and the shape of all sides

is impressed upon it. As there is very little strain upon open dies they can be made of cast iron often with great advantage, and take the proper form from the mold, but closed dies have to sustain an enormous strain and therefore have to be worked out from solid metal.

It is advisable in many cases, and especially when unskilled labor is employed at the drop-hammer, to use closed dies when the extra cost of dies, the cost of trimming, and the expense of extra waste of stock does not make the full cost of the forgings greater than it would be if made with open dies.

For some work which can be dropped or forged either way, it may be made with one or two blows with closed dies, while it would require more than twice as many to make it with open dies, and yet it may be cheaper to use the open dies on account of saving of stock, for being struck repeatedly first on this side and then on the edge, the extra stock is forced out at the end and being left on the bar goes into the next piece instead of being trimmed off as a fin, which would be necessary if it had been made in a closed die. The cost of trimming is also saved by the use of the open die. The cost of forging is to be reckoned from the bar to the piece delivered as a complete forging, and as it includes everything expended to produce it, the cost of all dies, trimming as well as forging, must enter into the account.

Value of Modern Machinery

In the majority of shops where drops are employed it would pay to have a die-sinking machine, not only that the cost of the dies is cheapened by its use, but also because dies can be made with it which could not very well be produced without it by mechanics not skilled in the specialty of cutting out accurate impressions in steel. This increased facility of making trimming as well as drop dies induces a greater use of the drop and utilization of the advantages it affords of producing uniformity. Pieces so perfected are cheaper than hand-forgings, and not only in first cost, but also in saving much of

the labor which would have to be spent on them if they were so shaped.

Some men seem to judge of the value of a machine according to the amount of time they can keep it running. They don't want to buy a tool they cannot keep constantly employed. That is not the criterion to go by. Tools are not to be valued in proportion to the amount of time which they must be employed to do the work, but to the amount of time which they can remain unemployed and still do the work. A manufacturer would hardly think it wise to put a large portion of his working capital into a machine that would be only used two weeks out of fifty-two in a year, and yet thousands of small capitalists have invested millions of dollars with ample profits in just such machines. Where are the machines? Standing outdoors in the fence corners all over the world. Agriculture machines? Yes; farmers find that it pays them to have tools to do their work when the field is ripe for the harvest, and to do it quick, and then let the tool remain idle until it can show its worth again, and manufacturers can learn the same lesson.

It may be observed that the die-sinking machine is not of the kind which is improved by standing outdoors in the fence corners; the best care is none too good for it, nor are the most intelligent and careful men too good to have charge of them.

Circumstances are of frequent occurrence which illustrate the benefits which may result from the ability to make uniform forgings. One instance of many like it was where a large number of machines had been manufactured and sent out by reputable parties. It was an old standard machine, but they had made some slight improvement in it, and as is often the way with slight improvements, this one was found to have spoiled the machine, for the "slight" alteration in one part had caused a great alteration in another part. Various plans were devised to remedy the defect, but all involved too much trouble, until at last it was discovered that a single forging, if made of a peculiar shape, would answer the purpose, but the

shape was so intricate and difficult to make by hand that it would not have been thought feasible to make it if it had not been pointed out that drop-dies could be cut with which the pieces could be made with uniformity at a moderate expense. This plan being adapted and the pieces sent out the defect was remedied, and the expense of returning the machines for repairs was avoided. This is simply the old story of the advantage of *interchangeable parts*; this version of it is only to show that the benefits of the system were obtained because the means were right at hand to secure them at once.

Prevision and Supervision

This suggests an illustration of that old story, the value of prevision and supervision. It may seem exaggerated, but it is a cold fact. Some men were once grouped together in a manufacturing company who had struck a business bonanza—a mine of wealth. The golden sands had run so freely that it hadn't been necessary for them to know anything about the real economies of manufacturing, and, of course, when they felt inspired to practise something of the kind in the name of "business," they saved at the spigot and slopped over at the open head of the barrel. Without bothering their heads much about the matter they carelessly classed the cost of supervision and of tool-making together, and both as unprofitable expenditure, or as one of them put it: "As a standing expense; like the brick walls of the shop."

One day it happened that a man came along whose eyes set so far back in his head that whatever he saw affected his brain. He looked a little into the way those men did business, and finally told them that they were not paying out enough for tools and superintendence, and he could prove it. They took an uncanny faith in this man, told him to go ahead, paid him the fee of a trust lawyer to manage the mechanical department of their business, and he permeated the whole establishment with his presence, as the sunlight floods the entire planetary system. He put thousands of dollars worth of tools into the tool-room, and set to work six

times the number of tool-makers they had employed before. In short, he modernized to the last extremity. The latest and best tools and methods he would have, and he did have.

What was the result of this headlong expenditure? It is that the average cost of the product of the establishment is reduced to about a third of what it was when he assumed control; the demand for the machines they make has kept up with his improvements; the output has increased in propor-

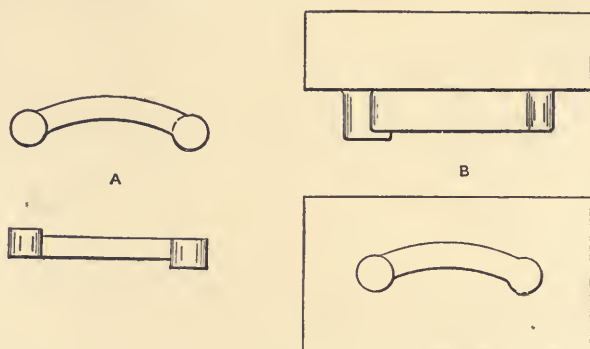

FIG. 99.—Forging and dies.

tion; more men are employed; the average of their wages is higher than ever; every one is satisfied, and prosperity abounds.

Hob for Forging Dies

In Fig. 99, a forging, of which a great number were to be made, is shown at *A*. As dies for making this forging, it being produced in great quantities, had to be renewed quite frequently, the making of the forging dies in the usual manner became quite expensive. In the shop where these pieces were manufactured, however, the expense of making new dies was greatly reduced by making a hob, such as shown at *B* in the cut. This hob was made of tool-steel and hardened, and had a projection of exactly the same shape as the piece to be forged. Die and punch are shown at *B*.

The block for the forging die, in which the shape of the piece to be made was to be formed, was placed, together with

the hob, in correct relationship in a hydraulic press, and the hob forced into the die-block the required depth by hydraulic pressure. By forcing the hob into the die-block, the metal displaced was thrown up around the side of the hob. This surplus metal was removed, and the die hardened. By making the dies in this manner, it was possible to renew the dies at a fraction of the cost of the dies made in the ordinary way. For irregular shaped forgings it would sometimes be necessary to make two hobs—one for the top and one for the bottom die.

CHAPTER III

DROP-FORGING DIES, THEIR DESIGN, CONSTRUCTION, AND USE
IN DROP-HAMMER, DROP-PRESS, AND FORGING-MACHINE

Combination Drop-Dies

WHEN a drop-die is fastened into place where it is to be used, it becomes a part of the piece into which it is fastened. The more firmly it is bedded, the more solid it will become, and hence the better it will fulfil its duties. The union of several pieces is intended to make substantially one sole, solid piece. If it is a lower die fixed in the drop-bed, it becomes a portion of the anvil, and if it is a top die fixed in the hammer-head, it becomes a portion of the hammer.

It is exceedingly difficult to unite two pieces of iron together, without welding, so that they will be, as to the effect of impact, as solid as one piece.

If you take the blacksmith's hammer in your right hand, and let it fall on the anvil, it will rebound; if, to prevent this, you stiffen your muscles, and exert your will, and bring it down with all your force, straining against a rebound, you will only induce a stronger reaction. If now you take the flatter in your left hand and let it rest on the peen of the hammer while you let the hammer fall, the hammer will strike flat and dead, without rising at all from the anvil. The flatter and hammer, together, are not as heavy as the sledge, but if you let the sledge fall, face down, upon the anvil it will rebound. You take the hammer again in your right hand, and place your left hand on the peen, where you held the flatter, and now let it fall. Do you stop all the rebound? No, it rises slightly from the anvil, and the tingling of your palm tells what occurred at the union of the hammer and the hand. You

are familiar with the facts; every one who has worked in the shop has made the experiments. I mention them only to direct attention to the absolute necessity of making union between two pieces of metal as compact and unyielding as possible, in order to secure the full effect at the impact of the force due to the blow. Much of it may be dissipated in open joints.

Union Between Metal Parts

These phenomena convey the suggestion that a falling compound weight, made up of two components, one above the other, in contact, but not connected, strikes first with the momentum of the lower part, and, second, with the momentum of the upper part, subject to a deduction for interference of the reaction of the first from the place of impact, which the momentum of the upper part must meet and overcome before it can be delivered at the same place. When the two parts are connected this interference will be proportionately less as the connections are more firm and compact. No union, short of welding, can be much more intimate than that of a flatter resting on the ball peen of a hammer, and yet we know that the break in the continuity of the substance, which occurs so slightly between these two pieces, makes a break in the continuity of the momentum of the flatter and the rebound of the hammer—otherwise this combination would rebound at one time like the sledge.

When a die is set in a hammer it transmits as much of the momentum of the hammer to the object which is struck, as overcomes the interfering reaction of the die, and if the die is small, in proportion to the weight of the hammer, there will be less of this interference to overcome than if large.

If it be desired to strike a blow with a drop-hammer that shall not rebound, it is only necessary to arrange a loose weight on and above the hammer, or to have the hammer in two disunited parts, of which two parts in the lower one alone has connection with the uptake and upholds. The greatest effect of impact, in proportion to the power required for lift-

ing the combined weight, will be given when the weight of the upper part exceeds that of the lower.

Considerable disappointment is sometimes experienced when it is found that adding to the weight of the dies does not proportionately add to the effect of the blow. The remedy is in adding to the weight of the hammer, but relief may sometimes be obtained by getting the dovetailing of the tenon to perfectly match that of the die-seat and fit the keys, so that they will draw the die up, as tight as possible, against the hammer.

But whatever the facts of the case may be in regard to the best method of fastening dies, for the purpose of getting the fullest and best possible results of the blow, it is well to remember that all things in drop-work have to give way before expediency. If it is expedient to fasten dies in a drop-hammer in a certain way, for any special reason, whether by that means the full effect of the blow is secured or not, that is the way to fasten them; and if, when thus fastened, the effect of the blow of a certain sized hammer is not sufficient to accomplish the desired object, then a larger hammer may be used. The principle of drop-forging is not persuasion, it is compulsion; it requires the furnishing of power, potent enough to overcome every interference and drive the reluctant stock into the dies, where it forces it to assume the form of the impression.

Die-Blocks and Impression-Blocks

It is not always necessary to use a piece of steel for a die which is large enough to make a die-block with a tenon of the size which the bed of the drop requires. The die proper, or the steel-block into which the impression is cut, may often be economically made of a much smaller pattern and held in a die-block, as well as have it all solid in one piece. The impression-block can be let into a wrought-iron or steel die-block by drilling and chiseling out a recess in the block, or by planing out enough to receive it, or it may have a block of cast iron around it.

When the steel is used as an impression-block, it is thus employed because its wearing qualities are demanded, and the requisite strength is partially supplied by the material of the block on which it is set.

There has always been a claim in regard to railroad-rails that they have two general functions: one to support strain, and one to endure wear; and as it seemed useless to be obliged to renew the whole rail—whose cost augmented with its weight—simply because it failed, in its less massive function, by wearing out, efforts have continually been made to separate these functions, and as the growing tendency of rails is to increase in weight, this consideration has the same tendency to increase in weight.

In some of these efforts, the scheme has been to make separate parts, to be permanently laid, for upbearing strength, while other parts, intended for wear, were made as light as was consistent with the purpose, and could be easily removed and replaced with similar parts. Other plans crossed the problem, and had the rail made double-headed, so that either side could be used for wear, while the opposite side always contributed its quota of strength.

Making Die to Resist Wear

Ingenuity in different branches suggests similar expedients; the replacing of the worn part of a rail is parallel to the making of the impression part of a drop-forging die of steel, to resist wear only, and hence making it no longer than will suffice for this purpose, leaving it to derive support to resist stress from the bed in which it sets. The double-headed rail finds its counterpart in a mode of making flat-faced dies which have a square cross-section, so as to use each of the four flat faces to sink impressions in. After the impression which has been cut in one side is worn out, another impression can be cut on either of the other sides, each side serving in turn for a face. If the drop has a dovetailed die-seat in the hammer or bed, packing is made of the necessary form, or the keys are modified to suit. Dies with straight sides cannot be drawn

up against the seat with keys, nor is there anything but friction to hold them firm in the seat. The time when dies shift in the drop, whether they are dovetailed or straight, is at that instant succeeding the impact, when the reaction takes place between the die and its bedding, the reaction which tingles the palm of the hand on the peen of the hammer.

The same objection lies against these four-faced dies that is raised against double-headed rails, which is, that while one side is used for a bed, and the other for a face, the bed-side gets so bruised that it is not fit for a face, and the face gets so cut and worn that it is not fit for a bed. If the impression be deep, however, it is much less trouble to redress the bruised sides than to plane away the whole worn impression to obtain, on that one side, a new face.

This plan works better on hammers which are wide between the uprights than on those which are narrow, as the strength of the cheeks—which they much need to resist the excessive strain of keying—is not so much impaired by removing the stock to get the extra width of the die-seat.

Keying Wide-Seat Dies

In the wide die-seats it is often very convenient to key in an open blocking-die alongside the finishing-die. These dies are only as wide as the stock is likely to spread in them when worked, and are often the scant profile of the finished forging as their use is for shaping the stock sideways so that it will drop into the finish imprint. Their durability is not the same as that of the finishing-dies, and therefore it is an advantage to have them separate therefrom, in order that the wearing-out, or failure of one, may not necessitate the renewal of both. It is the general rule that a pair of blocking-dies will outlast several pairs of finishing-dies.

It is very convenient to have keyed into the die-seat, along with the dies, some kind of cutting-off tool, to cut off pieces which are made from the bar, after all the work has been done on them which it is desirable to do before they are detached. These tools are liable to accident and require frequent sharp-

ening or renewal, and simple arrangements are easily made for doing it readily.

Places which have been blocked out and are detached from the bar, as they do not require the impression to go clear across the dies, may be dropped in steel impression blocks, or comparatively small dies which for support are placed in die-blocks of ample strength to resist breaking-strain. The wrought-iron or steel die-block, used for this purpose, has a recess cut into it which is of the shape and size of the die-patterns it is to receive. In order that this die-pattern or impression-block may derive any substantial and trustworthy support from the die-block in which it is embedded, it must fit it with absolutely perfect grip on all sides which are liable to be stressed. If it is not so encompassed it is liable to yield to the pressure, which forces it open beyond the limits of its elastic recovery and then cracks will soon make their appearance. Frequently the latitude, commonly described as loose-fit, will suffice to permit the die to spread beneath the force of the blow enough to crack it. The recess in which the die is held should take it in nearly to its full depth. The die-block should be of sufficient mass to absorb in itself the slight rebound of the die, and it should have no compromise with skill and economy in the matter of its being well-fitted and drawn by a dovetailed tenon to its solid bed.

First Principles in Holding-Dies

In the matter of holding-dies, it is a good thing once in a while to get back to first principles. Some of the old trip-hammer men around Worcester, Milbury, Sutton, and other places in the New England States, in the early part of the last century, used to make, instead of a slot or groove, a mortise or recess in their hammer-heads in which to hold the upper dies. These mortises were perhaps an inch deep, a quarter of an inch smaller at the bottom than at the top, and the dies were made to fit them loosely, and wedged in as tight as the hammer struck upon them. They were removed by striking them, first on one end, and then on the other; a very few blows sufficed

to loosen them. As long as a man runs his own hammer exclusively he could keep his small stock of dies in pretty decent fitting, but when the hammer was of general use, the dies soon became of no use, and would drop out, sometimes, when the hammer was running; so for such hammers, grooves were cut and keys used in Lowell, Waltham, and Saco, where trip-hammers were employed at making cotton-mill spindles and other machinery, work which is hard on dies, and requires that they shall accurately match and restrain their position. They soon came into universal use in scythe and gun shops, which were the principal places where the trip-hammers were used. Small trip-hammer heads are liable to split in driving keys, and when gains or slots were first used they were cut shallow, the tenons of the dies were short, and the keys narrow. The mortise is stronger than a slot, for it holds like a band on all sides. It appears to be the best way to fasten impression dies into the die-blocks.

Bolt Heading Dies

Whenever wrought iron, mild steel, or tool-steel is used in quantities as special or standard forgings, there the designer and fitter of forge-dies and formers finds employment, and usually at increased wages over those of the ordinary machinist and tool-maker.

It sometimes happens that the simplest looking piece is really the hardest to get a perfect-working former for, as many have found to their vexation. Bolt-heading dies are perhaps the simplest and best understood, but, as with everything else, there are certain things which if overlooked in preparing them in the machine-shop, often hinder their proper working. The common mistake with these dies is in planing the dies separately. They should be clamped on the planer or shaper, and planed in pairs and the halves numbered. With the two dies planed at the one time, even if the dies do come out of the chuck a little out of square, both dies will be nearer alike and fit better than if machined separately. What has to be looked for in either case, however, is that the end be square

with the sides. The two dies, if planed together, do not have to be perfectly true on the sides or bearing surfaces. They will come together, as they should, but of course the ends should meet squarely, or shimming will be required, and this should be avoided if at all possible.

When the dies have been planed on their four outside surfaces, the working surfaces are ready for attention. The pieces should be clamped end to end, so that the cut is taken lengthwise, and after the surfaces are finished and before removal from the chuck a V-channel should be cut for the guide for the center of the drill in the middle of the two faces. After the dies are taken from the chuck, if the ends do not come square and even, make them so, and they are then ready to be clamped together and drilled. The clamps should have two holes drilled for compression-bolts, just far enough apart to give $\frac{1}{8}$ inch clearance for the dies to enter easily. The dies should be mated on a surface plate, and the two ends that match the best brought together. A $\frac{3}{8}$ -inch piece of sheet-iron should be placed between the dies. This makes the hole slightly oblong and compresses the iron when the dies come together for heading the bolt. Otherwise the iron would slip through the dies when they operate. The drills should be the same size as the iron; but for neat, accurate work, a reamer should be used for finishing, as a twist drill sometimes makes a very rough hole. When reamed to the proper size, and before removing from the clamps, the piece should be marked 1 and 2 on one end and 3 and 4 on the other end for the guidance of the machine operator. To keep the dies steady when drilling, a cross clamp also should be provided to bolt the dies to the drill table. If left free to move with the drill the hole is apt to run-crooked. The dies are then ready to have all the sharp edges removed with a coarse file. The quality of the work and also the amount produced depends a great deal on how the dies are finished. If they pinch the iron on the corners of the dies more than at the middle of each semicircle they will not do one-third of the work. To get this bearing the corners should be filed round-

ing. The sharp wire edges should be removed also from the ends and made slightly countersunk. The dies should be made of tool-steel, and in hardening heat to a low cherry-red and cool in oil. The temper need not be drawn.

The heating-blocks are the next to receive attention. After all the surfaces are planed true, and to size as near that of the gripping dies as possible, they are ready to be hardened. They should be heated to a cherry-red and dipped in water and not drawn, as they should have very hard working surfaces.

The headers give more trouble than either the dies or the blocks, for they are hard to hold in the lathe and the working surface on them has to be finished, as any rough surfaces make a bad job on the head of the bolt, and the working-life of the header is cut down.

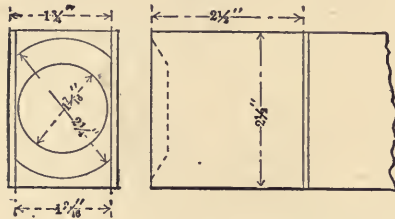

FIG. 100.—Header for 1-inch bolt.

The header generally used is $1\frac{3}{4} \times 2 \times 12$ inches.

The rule for the heading end of these headers is one and one-half times the diameter, with $\frac{1}{16}$ inch added for the thickness, and of course $2\frac{1}{2}$ inches wide or wider if wanted. For illustration we will take a 1-inch bolt; this would give a header as per Fig. 100, both ends alike. The rule for recessing the ends is: $\frac{1}{8}$ inch less than the width of the header for the inside circle, $\frac{1}{4}$ inch more than the distance across the corners for the outside circle, and one-quarter the diameter of the iron for depth of recess. For 1-inch bolts the dimensions of the header would be $1\frac{7}{8}$ inches for inside circle, and $\frac{1}{4}$ inch for depth.

For finishing the recess a couple of flat files, shaped on the end to the profile of the recess and used to scrape the rough surface after turning, will be found very handy; they should be ground true to size and made very hard. They can be made to clamp in the tool-post, but they are more handy and quicker used as hand tools. After the headers are scraped out

clean, finish them with a piece of fine emery cloth, so that the surface shows no tool marks of any kind. They are then ready to have the wire edges filed off and especially across the center, as the inside circle does not take out all the stock from the sides. File this surplus off even with the base of the circle and polish smooth. It is then ready to harden and should be given an oil dip at a low heat. Let me impress on the reader how that the rougher and harder the headers are made the less work they will do and the more they will crack in use; so don't let some "smart Aleck" bolt-maker talk you into making them like flint.

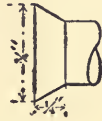

FIG. 101.
—Head bolt.

Countersunk head bolts are practically the same as square head, except that the head is made in the gripping dies and no header-blocks are required. The header is of the same dimensions as that previously described, with one end flat. The rule for countersunk heads is: Half the diameter of the iron for depth of head, and one and a half times for the large diameter of the head. Taking, for example, a 1/2-inch counter-sunk head bolt, the dimensions would be as per Fig. 101.

This same rule applies to button-head bolts. Cone-head bolts and rivets are made the reverse way from countersunk head bolts; that is, the head is formed in the header instead of in the blocks. The rule is: The diameter of the iron for the small circle, one and a half times this for the large circle, half the size of the iron with 1/8 inch added for the depth as per Fig. 102. Rivet dies for structural, boiler, and car work need more care than any other class of dies, for the reason that mild steel

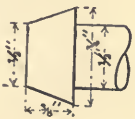

FIG. 102.—
Cone head bolt.

is now used to a great extent in this class of work, and the dies and headers have to stand great strains. Both dies next the head should be slightly countersunk and rounded nicely with a fine file.

Care should be taken to have plenty of stock on the sides of the headers, as they are under great strain in doing the

work. If the header is not wide enough to have $\frac{1}{4}$ -inch stock outside the recess— $\frac{3}{8}$ -inch would be better—have the header upset. The rivet produced is shown by Fig. 103. This gives practically the same rule for these heads as for the cone heads, except that the depth is $\frac{1}{16}$ inch less than the diameter of the iron.

It is a very common mistake for a machinist to drill both ends of a pair of dies the same and make both ends of a header the same, but this should never be done, unless you want four pairs of dies and four headers for the same size of bolts. Where both ends are made the same, they can't be repaired when worn out until both ends are gone, and that hangs them up and puts the machine out on that size until they can be fixed up; but if you have, say $\frac{1}{2}$ inch on one end and $\frac{5}{8}$ inch on the other, and two pairs of each, when a pair needs repairing you still have a pair in reserve, and the headers the same.

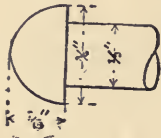

FIG. 103.—
Rivet head.

Forging-Press Dies for Making Hammers

The advantage of forging hammers and similar tools so as to preserve uniform shapes and density of metal was recognized before the advent of the forging-press, but this has helped matters a great deal, and its good points have been utilized by many firms. It is rapid and can handle a large variety of work, the cost of the work depending largely on the dies used, as they directly affect the time taken for a man to handle the different pieces.

I will endeavor to show their proper construction in as simple a way as possible, and begin on the simpler forms first.

Saving Unnecessary Movements

The main object in the dies should be to do as much as possible and concentrate them in rotation, so that each operation will follow the other without the workman having to lose time by doing unnecessary traveling from end to end of the press. This takes time and the steel gets cold, making it

harder on the dies and press, and very often hard on a man's patience.

First comes the shear blades which are of peculiar shape, as they are designed for nothing but hot shearing, and must cut the bar as square as possible, otherwise the steel buckles in squaring the face of the hammer, and requires extra work.

In Fig. 104, *B* shows the bottom blade with the guide to keep the top blade from overlapping, but still giving a tight contact for good work. *A* shows the top blade and on its sharpness and proper set depends the squareness of the cut and length of the piece, for when dull it "slides" the piece in shearing, and causes variations in weight, and as every piece should be of the same size, an extra $\frac{1}{8}$ inch will count up to quite a large amount in a day's run. The punch, punch-block and stripper come next, and the adjustable gages on the punch-block for locating the eye of different size hammers.

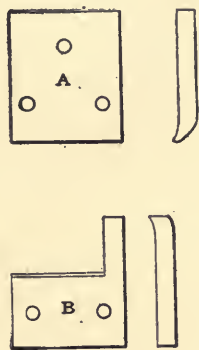

FIG. 104.—
Bottom blade.

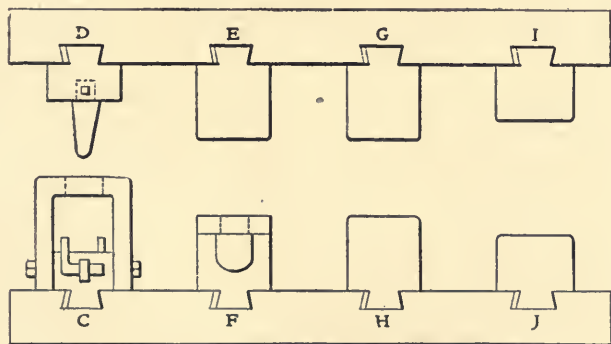

FIG. 105.—Complete outfit.

In Fig. 105, *C* shows the gages attached to block. The front and back is practically the same. The stripper is shown over it, and the punch-holder with the punch used. Where more than one press is in the shop the punch-holders should all be

made the same, so both punches and holders are interchangeable for any machine.

Making a Double-Faced Hammer

Suppose we want to make a double-faced hammer, like *N*, Fig. 9. This requires top and bottom drift dies *E* and *F*, Fig. 105, smoothing dies *G* and *H*, both top and bottom being the same in this case, and be sure that the working surfaces be rounded nicely to avoid cutting the hot steel.

The breaking-down dies, *I* and *J*, are the same as dies *G* and *H*, except having $\frac{1}{4}$ inch more space between them for

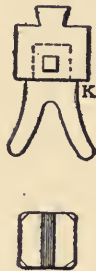

FIG. 106.

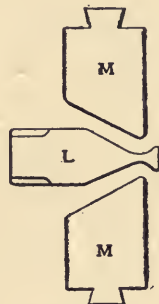

FIG. 107.



FIG. 108.

Making a double-faced hammer.

the edges of the hammer. • The surfacing-die is merely a broad flat top used to keep the hammers of one length before punching, and should be made short enough to take in the largest hammer made. The difference in size and length of hammers is made up by different thicknesses of iron-plates laid on the bottom die-table.

These dies will make from six to ten sizes of hammers, by making them for the largest size first and putting $\frac{1}{8}$ inch liners under the dies for each smaller size hammer made. All dies shown are in place on the press for each operation in Fig. 108.

The Finishing of the Dies

Great care is required that the dies should be finished as smooth and true as possible, as any tool-marks will work into

the hot steel, and if not true they will not only leave high and low places on the work, but get the tool out of square. These marks sometimes cause hammers to crack in hardening. All working faces of dies should be hardened.

In making a cross or straight peen hammer the dies *M M* leave the peen in the shape shown at *L*, Fig. 107, and the surplus is nipped off by the hot shears first shown.

For economy and saving of machine-work, a great many of these dies can be made with a cast-iron base, saving two-thirds cost of die in both steel and machinists' work, after the first set is made. But

great care must be taken to have the casting of the toughest possible mixture, otherwise it is liable to crush and get out of true. The sides are also liable to fracture where the gib of the steel face is keyed on. I think on the whole it is better to make these foundation-blocks of low-grade steel. They should be put together with keys and dovetails, using large fillits

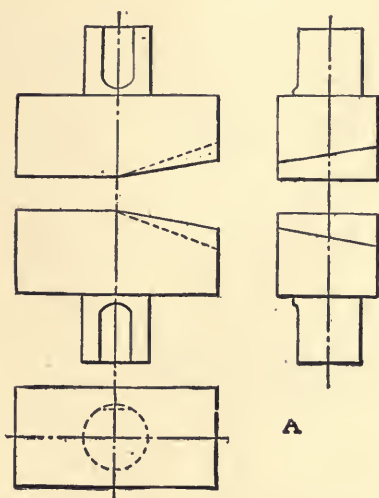

FIG. 109.—Breaking-down dies.

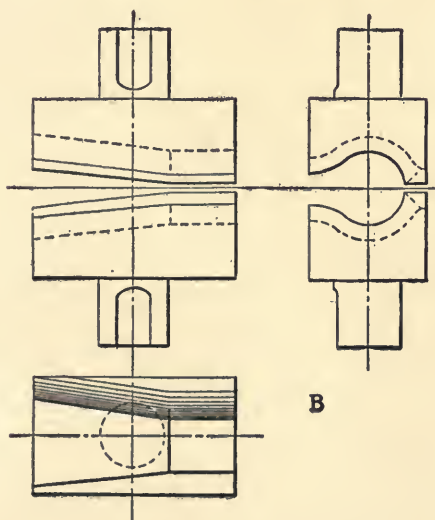

FIG. 110.—Formers for eye.

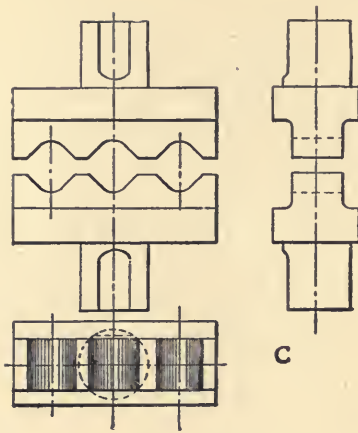

FIG. 111.—Swaging dies.

to strengthen the sides. The steel faces should be at least one-third the height of the finished die. When made too thin, they soon get soft, wear out of shape, and buckle, for they are constantly subjected to great heat and strains while in use.

Few Dies Needed for Forging-Press

It would seem at first glance that the variety of work on a forging-machine press would require a very large number of dies, but such is not the case. For with the addition of subblocks a great many dies can be used for different purposes, and even without them it must be remembered that a latitude of $1\frac{1}{2}$ inches

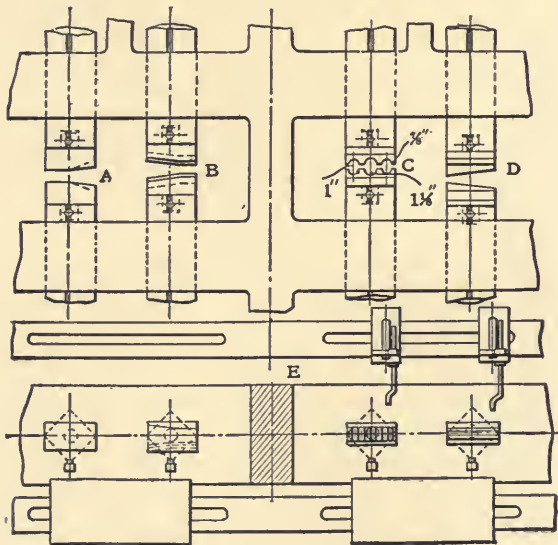

FIG. 112.—Arrangement of dies.

is possible. In tool-work we seldom forge a piece over 3 inches square, and one set of dies will answer for from 10 to 15 different size articles, as $\frac{1}{16}$ inch taken off or put on the hammer makes quite a difference in the weight, and often the only variation will be in the length, which makes several pounds difference in the weight.

We will take for example a single and double-faced spall-

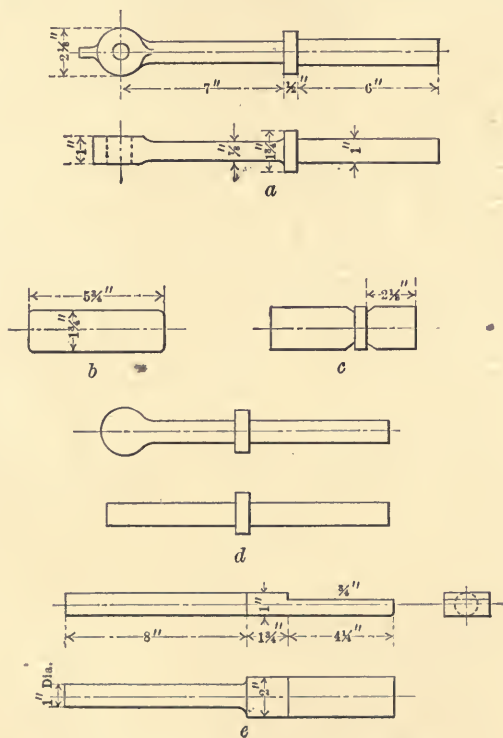

FIG. 113.—Forging-machine jobs.

ing-hammer and an ordinary stone sledge. One set of dies will make all of these tools, the only difference being in the bevels and the pinching-dies for the cutting ends. The straight sides are all the same, for no upsetting-dies are used on these hammers, as the beveling-dies to break down the edges on the stone sledges take their place. A certain amount of stock must be added to both hammers, as they kick back

unless pinched down, so as to leave about $\frac{3}{4}$ inch to be sheared off. The shear-blades should be sharp for this, as when they are dull they drag, and this fin must be ground off.

Most of the dies for this job are similar to those shown in Fig. 105.

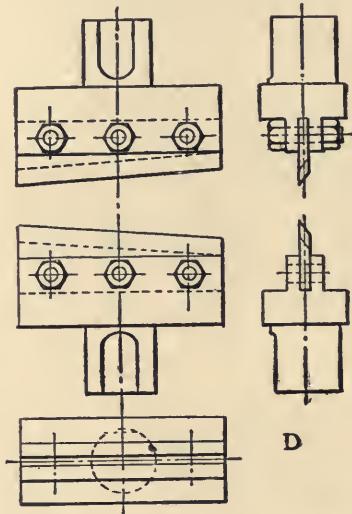

FIG. 114.—Machine dies.

Set of Tools for Forging a Fulcrum Bracket

During recent years much progress has been made in forging and in smith-work generally. The old and more tedious methods are dying out, as forging-machines and appliances are adapted to the work. Among these the swaging-machine deserves particular attention, and on straight work it is really a labor-saving device in every sense of the word. I

wish to illustrate a set of tools used in the machine for making a fulcrum-bracket in connection with railway-brake gear. These tools, however, are not confined to this particular job. As will be seen, the job is admirably suited for the swaging-machine; to drop-forge it would be a waste of time and material. Fig. 109 shows a set of breaking-down dies, Fig. 110 a set of formers for shaping the eye, Fig. 111 an ordinary set of $\frac{7}{8}$, 1, and $1\frac{1}{8}$ inch swaging-dies, Fig. 115 a set of cutters the construction of which will be readily understood from the sketches. Fig. 112 shows the arrangement of these dies in the machine and the method of securing in place. The stroke of the upper rams is $\frac{3}{4}$ inch, and they make 600 working-strokes per minute.

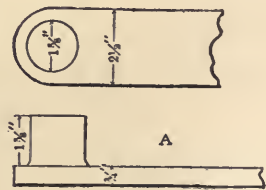

FIG. 115.—Pin-end.

All the lower rams are adjustable and can be instantly raised or lowered at the will of the operator. At the side of the machine is a hot circular saw.

The blank shown at *b* is cut off at the shears to the required length, very little being allowed for scrap. It is then brought to a working-heat in a suitable furnace, which should hold at least six pieces and is fed into cutters *D* where, by means of the gage shown, first one side of the collar is formed and then the other, as seen in Fig.

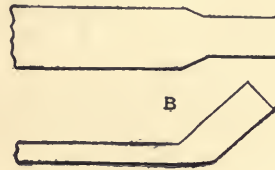

FIG. 116.—
Squeezed iron.

111. In the same heat the short end is rapidly broken down between the dies *A* and swaged to the required diameter by first passing it through the $1\frac{1}{8}$ -inch swage and the 1-inch in Fig. 111. The operation is finished by trimming the end to length in the hot saw, and all others are treated in like manner.

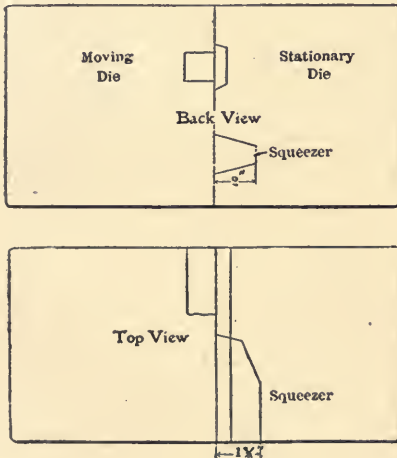

FIG. 117.—Pin-end die.

collar, and this is neatly finished off there until the eye is correct in distance from the collar, when it is again released and the bit formed on the end sawn off.

It should be understood that these operations must be

For the second operation, the other end is properly heated and rapidly broken down under dies, Fig. 109, and appears more or less like *d*, Fig. 113; the enlargement for the eye is then formed by passing it through the dies, Fig. 111, and the flat of dies, Fig. 109, several times. The swaging-dies, Fig. 111, are then opened to receive the round part between the eye and collar,

rapidly performed, two heats being required to finish the piece. It will be noticed that dies, Figs. 109, 110, and 114, are so set as to produce the finished size without any adjustment.

The piece at *e*, Fig. 113, is another forging produced on this machine at such a price and with such a finish as to give perfect satisfaction all around.

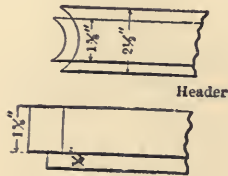

FIG. 118.—
The header.

Forging Dies for "Pin-Ends"

One of the jobs set down as impossible to be done on the forging-machine was the forking of "pin-ends" for switch work, but it was found by a little experimenting that they could be made very nicely and rapidly, so that what formerly cost 18 cents each could be made for 2 cents each by the new process. The pin-end is shown at *A*, Fig. 115, and the dies at Fig. 117. Fig. 116 shows the iron as it comes from the squeezer, enlarged the small way of the iron and bent to a sharp angle, so that the header will force it into the dies. The bending is done by the operator as the dies squeeze the iron, he forcing his end up to form the bend. The squeezing and bending is the first operation, and the piece is reheated for the

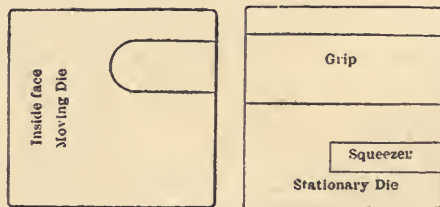

FIG. 119.—Squeezing die.

finishing upset, and should be very hot to do a good job. The moving-die in the pin-recess should be given plenty of taper and should be very smooth, so that the iron will slide into the recess without any trouble when the header strikes it. Any sharp corners should be carefully filed off, or they cut the

iron and the job looks bad when finished. The header should be tool-steel. The inside corner which comes next the bar should be given a $\frac{1}{8}$ -inch rounding to form a fillit. It should be given an oil-dip at a low heat.

It is sometimes necessary that a job requires so much extra stock that to upset it would require going over it many times, and would make the job so expensive

that it would be cheaper to do it by hand. Such an obstacle was encountered in making a pair of dies for "head- rods" on switch-work. We tried upsetting the stock, but found that the outer end would waste away before we could get the desired amount of stock, as we had to heat them four times, and the job, when completed, was very unsatisfactory. We decided to weld on a piece to gain the desired stock, and so cut the heats down and at the same time the expense also. The bar being $\frac{3}{4} \times 2\frac{1}{2}$ inches, we took a piece $1\frac{1}{2} \times 2\frac{1}{2} \times 5$

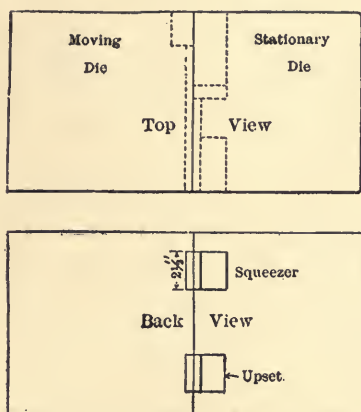

FIG. 120.—The die construction.

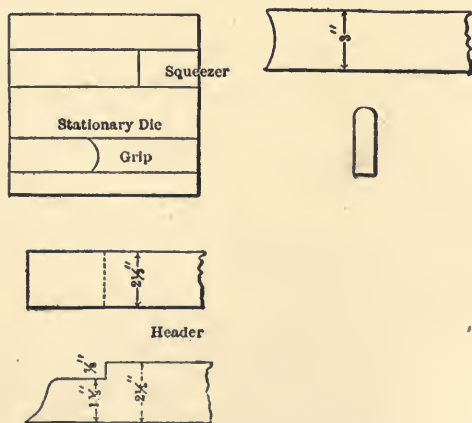

FIG. 121.—The die construction.

inches and laid it on the bar, heated it to a fair welding heat and upset in the machine, the dies being so arranged as to round the back of the "dab" next the operator. The construction of the dies, header, and punch is given in Figs. 120 to 123.

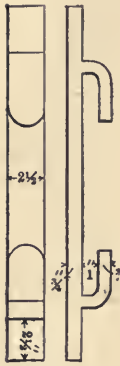

FIG. 122.—
The die
construction.

In this operation there need be no heat at the portion next to the operator, as this part is punched out, but the part next the plunger should be a nice soft "snowball," as they express it. *B*, Fig. 123, showing the position of the iron as the plunger upsets it, will make the meaning clear and also show the "dab" as it comes from the furnace. The operation consists in placing the "dab," or piece, about $\frac{1}{2}$ inch farther back than its final position, then placing it carefully in the furnace (should be an oil-furnace), and when a good soft heat is reached the "dab" will be stuck and the bar can be handled easily. Get it into the upper portion of the dies and let the machine squeeze it; then drop to the lower recess and upset it. This leaves the

end ready for punching.

The arrangement of dies for punching the slot is practically the same as previously shown. Of course the finish of the dies, the clearance, the grips, and the matching of them plays

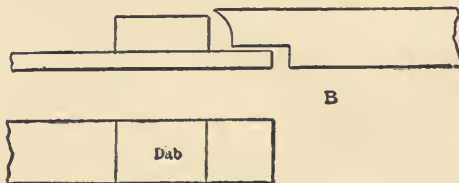

FIG. 123.—The die construction.

an important part. If the workmanship of the little details be neglected by the machinist, an expensive failure is apt to result.

I have one more die to show which is entirely out of the ordinary line of work done on these machines, and does a very

neat and quick job. This is an eye-forming die for round, square, or flat iron. The one shown here at Fig. 125 is for 1 inch round, as shown at *A*, Fig. 126. There is no header required, as it has no work to do in this case. It is necessary to have a $1\frac{5}{8}$ inch pin made to squeeze the eye over on the final operation, and there has to be a plug screwed in the moving die marked *X*, as this is a bender, and projects into the stationary die. When they are closed the blank is bent like *B*, Fig. 126, this being the first operation. The eye is closed down just enough to hold the $1\frac{5}{8}$ -inch steel-pin, and placed at an angle in the top recess of the die, so that the

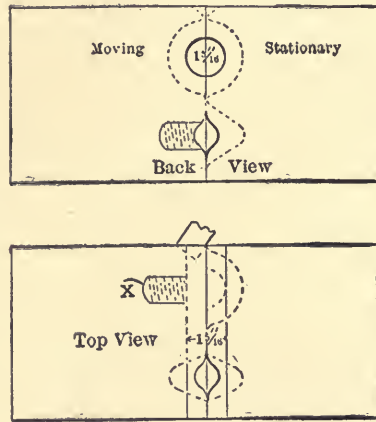

FIG. 124.—The die.

end of the iron is slightly above the top of the moving die. It is then ready to be squeezed to place, and if it doesn't form the eye as it should and the end is not tucked to place, it should be squeezed a couple of times more and each time held straighter until it comes right, when the pin is knocked out and the eye finished. The pin should be tapered at both ends

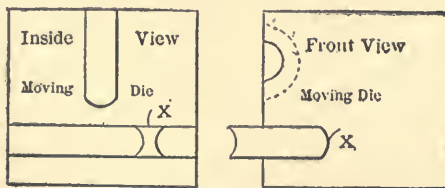

FIG. 125.—Eye-forming die.

and be about $3\frac{1}{2}$ inches long. There should be several of these, as one gets hot and has to be cooled off. All channels and recesses in these dies should have lots of clearance, or they will give trouble. They should be scraped as smooth as it is

possible to get them. Care should be taken also that they are just slightly larger than the finished eye. If too big the eye will not be good, and if too small they reduce the sides of the iron, and this is really worse than being too large. A good plan is to use an eye just the right size, made by a blacksmith, and fit the dies to this pattern, having them so that the eye works in the dies loose. No grip is used, as the bender on the first operation prevents the iron from slipping.

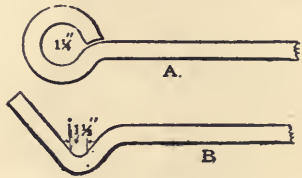

FIG. 126.—
One-inch eye rod.

*Forging Dies for Round and
Square Upsetting*

Working-dies of this type for forging-machines should generally be made of cast basic steel, as this material is easily worked and can be depended upon to last. I prefer it to tool-steel, as the latter often cracks and peels off with little use. The tool-steel also often has hard spots almost impossible to machine. Cast iron is used quite extensively for these dies, and to illustrate the difference be-

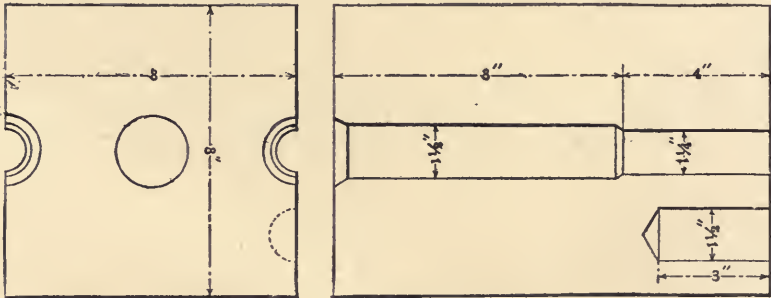

FIG. 127.—Upsetting die.

tween the two metals for this purpose, one pair of cast-iron dies for truss-rods lasted about three days and then had to be worked over, while the basic steel on the same work ran six months and was still in good condition.

Perhaps the simplest dies for these machines are the truss-rod dies mentioned above. They should be planed in pairs

and perfectly square. The dimensions of course vary, but 8 x 8 x 12 inches is very good and will generally meet all requirements, except in very long upsets, and in this case the dies should be as long as the machine will take. A hole should be cored through the center to pass a rod through to handle them with. The sketch, Fig. 128, gives the general dimensions for $1\frac{1}{4}$ -inch rods upset to $1\frac{1}{2}$ inches, as used in bridge

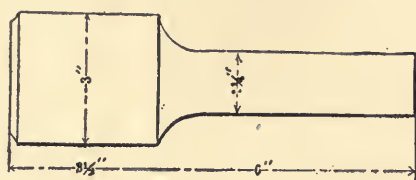

FIG. 128.—Upset rod.

and car work, the upset being 6 inches long. A V to guide the drill should be planed in the center of each face before removal from the planer to serve as a guide for the point. In boring these dies sheet-iron strips, $\frac{3}{8}$ inch thick, are placed in the joint before the $1\frac{1}{4}$ -inch hole is bored; this provides for the grip of the iron. The strips should be removed before counterboring for the upset, as, if this is overlooked, the upset

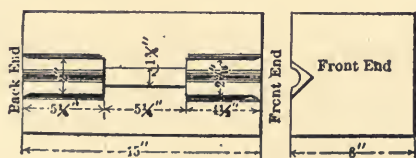

FIG. 129.—Upsetting die.

will be oblong and shy of stock on two sides, and full on the top and bottom. It will be noticed that there is a $1\frac{1}{2}$ -inch counterbore 3 inches deep below the grip in the back portion of the die. This practically doubles the working capacity, or life, of the dies. The plunger, in upsetting the iron, wears the outer portion of the dies quite rapidly and the end of the rod is left too large. This causes trouble when the work goes to

the threader, as the end won't enter the threading dies. The counterbore is to work this enlarged end down to the right size and answers the purpose nicely. It should be put in every pair of dies.

Drop-Forging Dies for Gun-Work

I had at one time a number of duplicate sets of drop-forging dies to sink by the piece, and when the men on the job learned the price I took them for, they smiled and said that I would not make day pay. There was not only day pay, but the limit of piece-work pay reached, and some time to loaf to make things balance.

The piece to be forged was part of a rifle which figured extensively in our settlement with Spain. It consisted of magazine plate, trigger-strap, and lower tang combined in one piece, and was like Fig. 131, at *A*, as near as I can remember it. The first operation was to make the usual zinc templet, first drawing the finish-lines and then adding

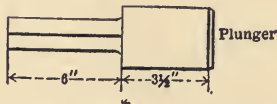

UPSETTING ROUND TO SQUARE.

FIG. 130.

finish and draft, as will be understood by all die-sinkers. Next a piece of tool steel was got out, $\frac{1}{8}$ inch thick, and the size of the face of the finishing-dies, which I believe was about 8 x 12. The blocking-dies, which in this case were steel also, were about 12 x 12, but by working from one side and end the difference in size did not matter. After squaring the plate nicely, four holes were drilled in the corners, as shown, care being taken to see that they went through square, so that the plate would reverse without being out of square on the die.

The zinc templet was then clamped on the plate in the required position and marked around, and the plate was drilled and filed out to the form of the templet, as shown in *B*. Two small templets, *C* and *D*, were then made the shape of the inside of the trigger-strap, with projections, as shown, to fit in the large templet, and with the locating marks put on. These

pieces were held in position with solder and were taken out or changed as desired. The templets were then heated, the edges were rubbed with cyanide and dipped in oil, giving them temper enough to resist the stem of the cutter, whatever pressure might be put on it.

I had now a nice profiling former, and after making some cutters like *E*, Fig. 131, of $\frac{1}{4}$ -inch drill-rod, I was ready for business. The templet finished, it was carefully set to one side and end of a die and clamped, and the four corner holes

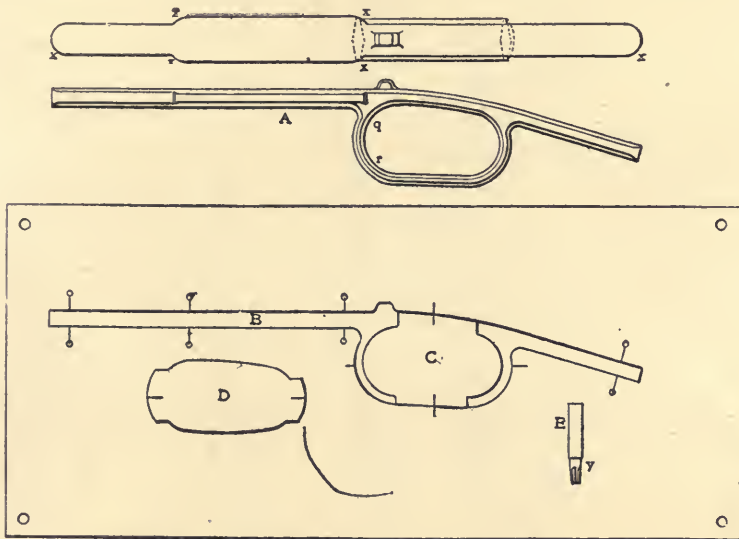

FIG. 131.—Magazine plate and die.

were drilled and reamed to a depth sufficient to hold a pin securely, and then reversed on the mate-die and the holes drilled and reamed, always working from edges, which would coincide when the dies were face to face, and always reversing the templet. Pins were next fitted to the holes, the outline was scratched on the dies through the templet and traced with tracing chisels, and the impression was roughed out with the usual two-lipped cutter. The templet was then put on, the end cutter *E* was put in, and the last trip around was made with the hole full of oil and the fastest speed of the machine.

The lines *O* were put on for stop-marks and the shank *y* of the cutter served as a former pin on the templet. As the impression was of different depths, cutters had to be made with a length of taper corresponding to each depth. The only chipping was at the circle *x* and from *q* to *R*, the trigger-strap being wider than the tang. The cutter worked so nicely that it was only necessary to file where there was chipping. After cutting out for stock clearance and putting in the sprue cut,

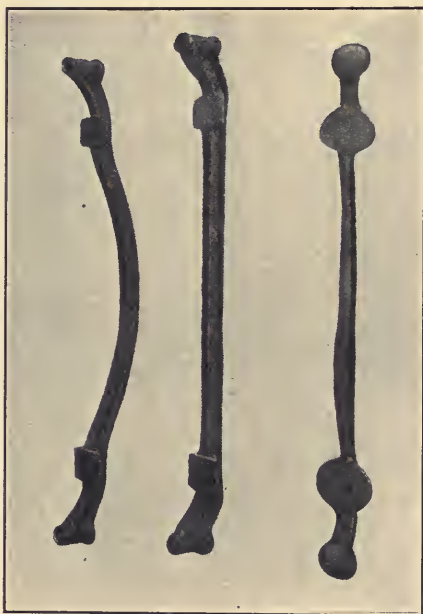

FIG. 132.—The axle in three stages.

the dies were “flashed” and a cast was taken to prove the chipping only, the match being perfect every time.

I will say here that there were six pairs of finishing-dies and six blocking-dies, making twenty-four impressions, and the balance on the first of the month was very satisfactory.

Unusual Job of Drop-Forging

The forging in question is that of an automobile axle, which from its length makes it an unusually difficult piece to

forge; so much so that automobile manufacturers have preferred to use bronze castings or welded axles, rather than attempt the task of forging the axle out of a solid bar. Special interest is also attached to this job, as there have been many attempts to forge these axles, experiments having been conducted by some of the leading manufacturers of the country, which have resulted in costly failures. The job is all the more remarkable in that the axles are being made in a small shop, with the tools available.

In Fig. 132, to the left, is shown the completed axle, drilled and reamed and fitted ready to be assembled. In the

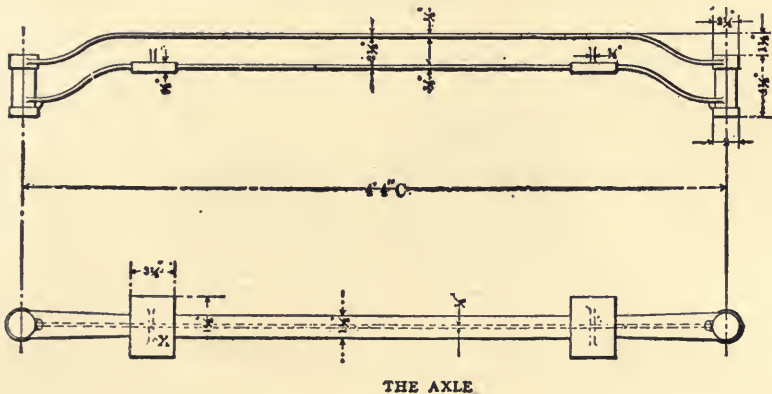

FIG. 133.—Forging dimensions.

center is shown a finished forging, before it receives the final bending. The axle leaves the forge-shop in this condition, owing to the fact that for different automobiles, different bends are required, the axles being otherwise identical. Fig. 133 gives the general dimensions of the forging.

The forging is made of "Clipper" steel and is of stock $2\frac{1}{2}$ inches square and cut to length, each piece weighing about 44 pounds. The heating is done in a coke fire, great care being exercised to secure a uniform heat.

The breaking-down dies are shown in Fig. 134, and present no unusual features. The stock is struck into the die at the *left* until the two balls have appeared, when it is struck in

the dies at the *right*, to form the pad at *X*, Fig. 133. These dies are cast iron, used just as they came from the sand, without even being touched with a file.

The breaking down is done under a 4,000-pound steam-hammer of the usual type. As a part of this breaking-down, the forging is taken to a 1,000-pound drop-hammer near by, and at the same heat the middle part of the axle, just inside the pad, is broken down and roughed to size. There are no gages or stops of any kind on the breaking-down dies for locating this pad, this being done entirely by the judgment of the operator.

The broken-down axle is shown at the left in Fig. 132, the breaking-down operation being of course the same for each



FIG. 134.—The breaking-down and finishing dies.

end. The bend at the ends is done by a helper and sledge, as the axle lies on the anvil of the drop-hammer after the breaking-down is complete. This operation is also left to the judgment of the operator, and while it is a crude way to describe, is really very quickly done and also very accurately done.

The finishing-dies, Fig. 134 at the right, are of steel, and present nothing unusual. The iron band shown shrunk in place is to hold in position an addition to the die that was found desirable, as it proved more satisfactory to make these dies take in as much of the axle as possible. In this operation the pad is inserted in the lower die, and if necessary the sledge is used to bring the extreme end over the die in its proper place. Great care must be used when heating the stock during this operation, the heating requiring more time than the work of forging.

The first stroke of the hammer, when the forging is in the finishing-dies, is a light one, and is more for the purpose of settling the forging into place. After both ends have been finished the axle is drawn to size in the center, the distance between the ends being gaged. It is possible to maintain a limit of error of $\frac{3}{16}$ inch in the forging, as shown in the center of Fig. 133. The bending at the factory is done in a screw-press with cast-iron dies, stops being provided to catch the pads at the ends.

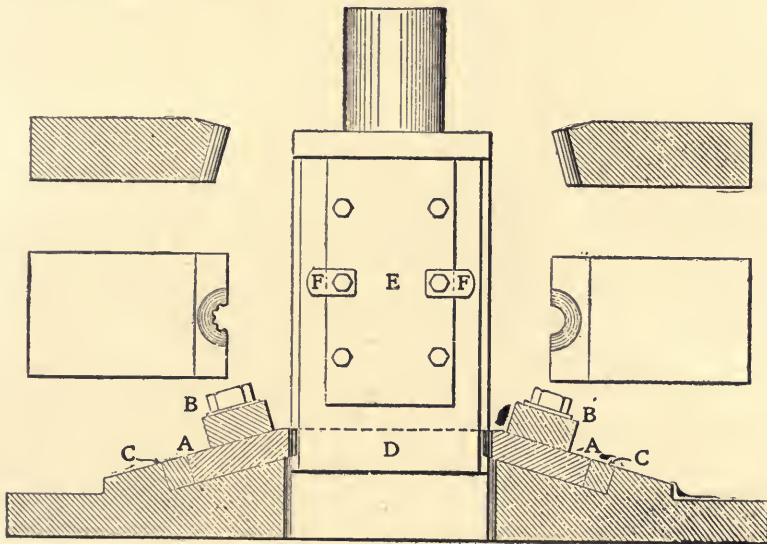

FIG. 135.—French trimming die.

Throughout this job the personal equation enters in very largely, without which it would be impossible to do the job at all. The operator was a colored man who worked with one helper. The dies have been excellently designed, there being but about 8 pounds of scrap left during the operations, the finished forgings weighing about 36 pounds. The flow of the metal is almost perfect, and the axles are knocked out very rapidly. The entire operation is a most happy combination of drop-forging, drawing, and hand-work.

The axles were the only forged axles shown at the auto-

mobile show in Chicago, in 1907, and attracted considerable attention. They are being forged by the Bates Forge Company, of Indianapolis.

Trimming Wrench Blanks in Dies

Having several thousand wrench-hammers to round up and straighten on the back, it was found necessary to find some method speedier and cheaper than milling. The hammers, being forged, had the usual fin, and this had to be gotten off. The arrangement shown is what was used. Fig. 135 shows a section of bed and cutters, and an elevation of the

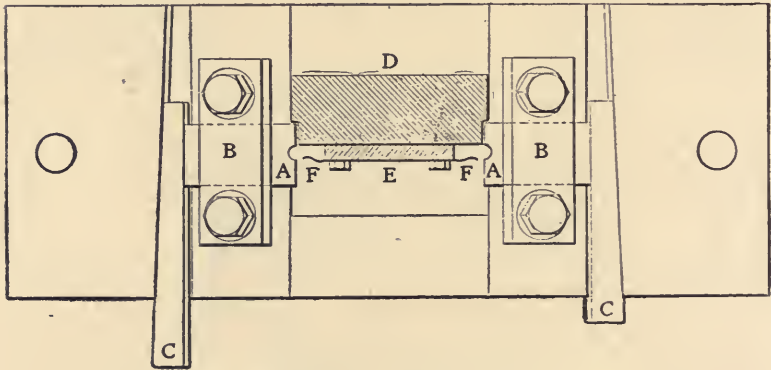

FIG. 136.—Plan of die.

punch or slide. The bed has the inclined grooves to receive the cutters *AA*, which are held in place by the clamps *BB*. Adjustment is obtained with the wedges *CC*. The punch *D* has the hardened steel-piece *E* secured by cap screws. Spring clips, *FF*, held by one of the screws on each side, hold the work when it is placed in position. Fig. 135, at upper left and right, shows sections and plans of the cutters. The serrated cutters are used to take a roughing cut, after which the work is passed through three times with the plain cutters, the last cut being set to take not more than .0015 inch, at a cutting speed of 11.66 feet per minute. This speed seems slow in face of the fact that the corrugating was done at a speed of 29.16 feet per minute.

I can see no reason why this should be so. I know, as a matter of fact, that we could get satisfactory results at what would seem only a moderate cutting speed.

The cutters require clearance of $2\frac{1}{2}$ degrees. It is not absolutely necessary to set the cutters at an angle as shown, but it makes them easier to grind and keep in order. The best results were obtained with a very slight top rake on the cutters, not more than the concavity that a four-inch wheel would grind. Too much rake is worse than none.

We used several grades of steel for cutters and found very little difference when properly hardened. I got the best results

by heating in gas and hardening in water at 78 to 80 degrees F. and finishing the cooling in vaseline, without drawing, using plenty of cyanide. Do not depend upon the cyanide

to do the hardening, but heat your steel as hot as the quality of steel will stand without damage.

I trust the reader will pardon me if I digress and ride a pet hobby a lap or two, but the subject of hardening and tempering this class of tools is one which should receive more attention. I find that the average blacksmith does not appreciate what is required of a tool of this sort. He always knows just what you want, and usually does just what you don't want. He will concoct solutions, with all the gravity and mystery of a "voodoo" doctor, when pure water will do better. Solutions without



FIG. 137.—
Wrench before
trimming.



2



FIG. 138.—
Wrench after
trimming.

proper heating of the steel are deceiving; they only case-harden. A tool for heavy duty must be hardened through. If the right degree of hardness can be obtained without drawing, so much the better. This is not so hard to do as it seems. Clean water at the right temperature, a good heat in charcoal



FIG. 139.—Belt punch.

or gas, time enough in the water to secure sufficient hardness, then a quick transfer to a heavy bodied oil to finish cooling.

To get back to the wrench job: lubrication is a feature that must not be overlooked. I used a heavy solution of vegetable-oil, soft soap and water—5 pounds of soap to the gallon of water. This did better work than the oil, the supply being at about 15 pounds pressure, through $\frac{1}{8}$ -inch nozzles attached to a supply pipe.

Trimming Cheap Hardware

In the manufacture of the cheaper grades of hardware, malleable-iron is largely used instead of steel-castings or

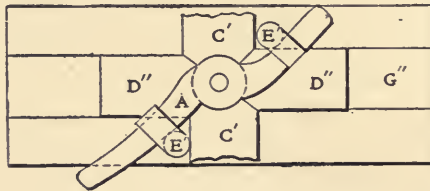

FIG. 140.—Plan of die for trimming A, Fig. 139.

forgings. The low price at which the articles are sold will not allow any expensive work, such as milling, to be done on them. They are usually just drilled and put together. In the better grades of this class of hardware, such as belt-punches, etc., making the joint at A, Fig. 139, is the principal expense,

and the die shown in Figs. 140 and 141 was designed to trim the joint, which can thus be done neatly and cheaply.

In making the belt-punch, the rivet-hole is first drilled and then counterbored a little more than half-way through. The part to be trimmed is then put on *B*, the stem of the die, Fig. 141, which just fits the counterbored joint. It is then swung under the head of the strippers *E*, which also act as

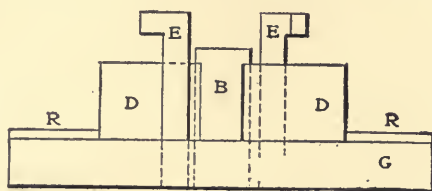

FIG. 141.—Die for trimming *A*, Fig. 139.

stops. The part to be trimmed must be counterbored to such a depth that it will rest upon the stem *B* and also upon dies *D*. Fig. 140 shows the top of the die, and *C'* shows the position of the punch when the dies are set up. In making the die, the parts, *D'*, which are the cutting parts of the die, are doweled and screwed to the base *G*, meeting at the center to allow the hole to be bored the size of the stem *B*. They are then cut away to the required shape.

The punch, Fig. 142, of which *F* is the holder and *H* the stem which fits the press, is made the same way as the die. The ribs *R* are put on the die-base and punch-holder to prevent the die springing away from the work. The hole in the die should be tapered slightly larger toward the back thus allowing it to strip easily.

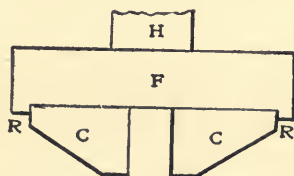

FIG. 142.—Trimming punch.

A Slab-Truck for Forge-Shop

The cut, Fig. 143, herewith illustrates a slab-truck that is made to handle both the hot and cold billets around a forge-shop. It is made up entirely of iron, hence there is no danger

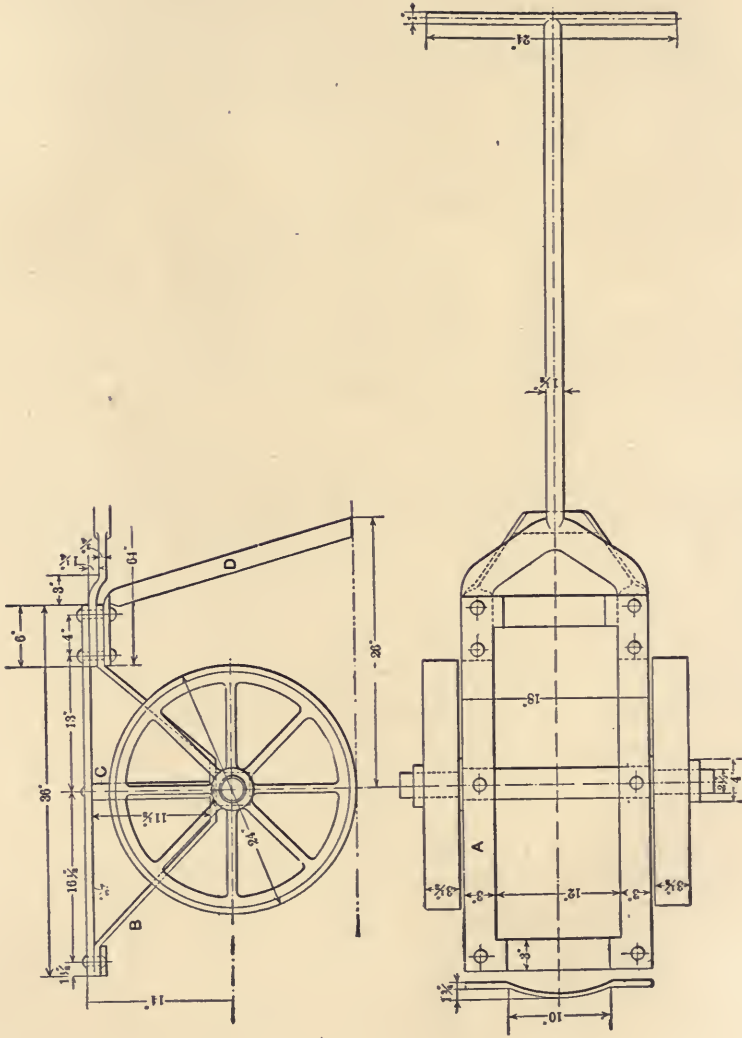

FIG. 143.—Slab-truck for the forge-shop.

of destruction when handling billets at a white heat. The height has been designed to conform to that of the furnace-door and to top of the bottom die on the steam-hammers in use. A heavy hot slab may be pulled from the furnace and wheeled over to the anvil of the steam-hammer with greatest ease. The construction is very simple and inexpensive. The axle is made of 3 x 3-inch wrought iron, and the two wheels are 24 inches in diameter, $3\frac{1}{2}$ -inch thread, and made of cast iron. The slab rest *A* is made of 3 x $\frac{3}{4}$ -inch wrought iron, supported by the 3 x $\frac{3}{4}$ -inch braces *B*, with a piece of 1 inch wrought-iron pipe *C* acting as a strut. The whole is bolted down through the axle by a $\frac{7}{8}$ -inch bolt passing through the pipe, and each end riveted over. The support *D* is of $\frac{3}{4}$ x 2-inch wrought iron made in *U*-shapes, and is very rigid. The

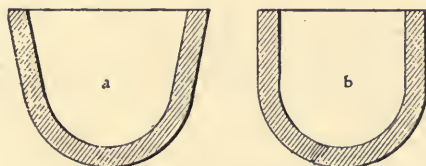

FIG. 144.—Hand-vice handle before and after “closing.”

handle is of $1\frac{1}{2}$ -inch round wrought iron, welded to a $\frac{3}{4}$ x 3-inch yoke. The hand bar is 1 inch in diameter by 24 inches long for the accommodation of two men. The truck, as a whole, has been found very useful and substantial, and since its trial many others have been constructed.

The Possibilities of Planing-Tools for Finishing Forgings

We have had occasion a number of times in manufacturing to do work with special shaving or planing tools. This has proven a much more accurate and a cheaper method than the usual way of milling. We ask ourselves, has the milling cutter so much advantage over the planing-tool in removing stock and machining a true surface? We all know that a cutter, to work free, must have sufficient rake to allow the chips to be removed without too much breaking up, and there must be

enough metal backing up the cutting edge to withstand the strain of the cut. This is the case with all cutting-tools, whether a drill, a milling-cutter, or a planer-tool. The planer-tool has the big advantage, in that it can have ample rake for free cutting, and at the same time have plenty of backing to support the cutting-edge.

Now, why not give the planing-tool more cutting edges? Give it a wider cut, and make it in series, to first break up the surface with serrated tools and then follow with tools to remove the stock and make the finishing-cut. The question that presents itself is: what is the limit of size of cut that can be taken? Given a machine of sufficient strength and proper

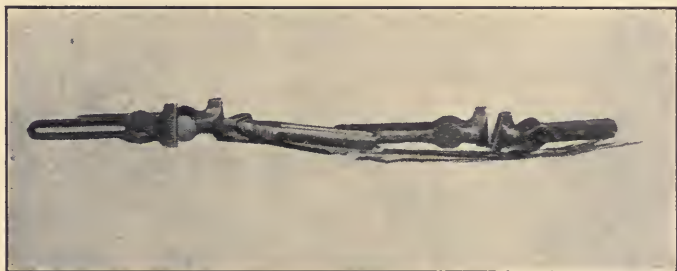

FIG. 145.—Hand-vise forgings “before” and “after,” with shavings.

tools, may not a surface be machined in one stroke that in the old ways takes hundreds?

Work on Hand-Vise Forgings

With a profiling fixture, the hand-vise jaws shown kept a man comfortably busy to turn out 150 in ten hours. With the set of dies illustrated, a boy easily finished, in three operations, 400 in $9\frac{1}{2}$ hours. With a stroke of sufficient length, and by building the die in series, this could as well be increased to 1,200 pieces in the same time. The length of the cut around the vise is about nine inches, and it was made at about 15 feet per minute. If a 9-inch cut is possible and practicable, why not 18-inch or 36-inch?

Another example is the checkering and *V*-grooving on the

face of the jaw. These operations were both done on a 14-inch Hendey shaper. The checkering was done at the rate of 1,000 per day, and we did not think the most exacting would find fault with 300 in the same time on the milling-machine. The grooving went easily at 1,500 per day. The work will, we think, compare favorably with the average milling-work. We find that with proper rake on the tools there is less tendency to spring the work than in milling. In some instances we have found it possible to use as much as 20 to 30 degrees of rake.

Another point in favor of this form of tool is that it does not need relieving on the return-stroke, as the work can be

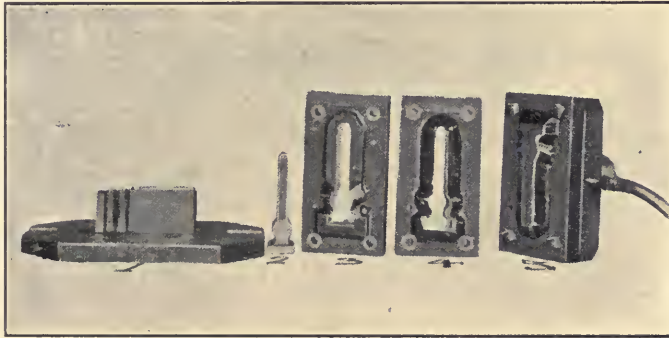

FIG. 146.—Punches and dies for trimming hand-vise forgings.

removed before that occurs. Should the cutter return over the work, only the last cutting-edge would touch. This is not a serious fault where the tool is strong and heavy and the material soft. This practise allows the cutter to be fastened solidly to the ram of the machine, making it less liable to spring or chatter.

In the photograph, Fig. 145, are shown some of the forgings in different stages. At the left are the rough forgings, showing the slot or gutter in the handle before it was closed. It was necessary to forge the slot with considerable draft to the sides, as at *a*, Fig. 144, which is an enlarged section across the middle of the straight part in order to get the required

depth. They were put through a drawing or closing-die to bring the sides parallel, as at *b*, before putting them through the shaving-dies. At the center of the picture is a forging after it has been through the roughing-die, showing the serrations, where the cut was heaviest. At the right are shown some of the forgings after the finishing operations. The dies shown in Fig. 146 were made the reverse from the usual way. The punch was fitted to a die-block on the bolster-plate, and the dies to a holder in the ram. This arrangement made it easy to place and to hold the forgings in position, by cen-

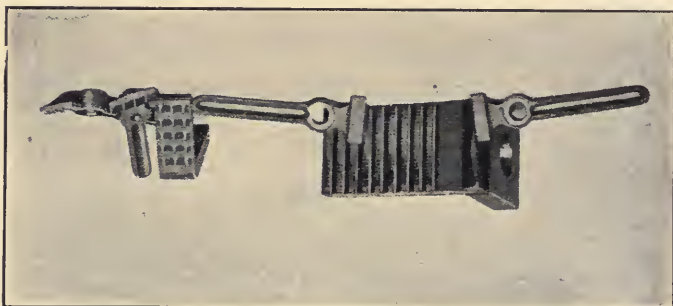

FIG. 147.—Tools for “checkering” and grooving vise jaws.

tering the slot on the projection on the punch. The work was flooded by pumping oil through a tube connected with the die-holder, shown at the right in Fig. 146. The dies were $1\frac{1}{2}$ inches thick, made straight on the inside and with a 30 degree rake on the cutting-edge. The cut was taken by roughing-dies and varied from .005 to .040 inch, being heaviest around the boss where the die was serrated. The second die was enough smaller than the first to clean up the serrations. The third, or finishing-die, had a uniform cut of about .002 inch.

The tool for doing the checkering on the face of the jaw is about $2\frac{1}{2}$ inches wide and was made to fasten direct to the clapper-block. The cutting-part of the tool projected back of the center of the clapper-block, under the ram. The cutting-edges of the tool were made by a series of steps of about .005

inch, and were given a rake of about 15 degrees. This was found sufficient to give a free cutting-edge. The object of putting the cutting-edges back of the center of the clapper-block was to prevent the cutter from "hogging." With the cutter in this position the tendency is to spring away from the work under a heavy cut. The cutter for making the grooves was similar to the one doing the checkering. Fig. 147 shows the cutters and the work.

Forging Under Steam-Hammer

For pieces of considerable size and bulk the steam-hammer is substituted for the hard forging-process. In this method of forging, the hammer should be of a size to suit the size of the work. The hammer-man must exercise a good deal of skill and judgment as to the power and speed of the blows delivered to the piece, as a too powerful blow will crush it, and in the case of high percentage of nickel, fissures and cracks are liable to develop which it will be difficult to get out, and which may show in the finished product.

This is especially true if the piece is allowed to fall below the forging temperature, or if the blows are not distributed evenly. If the blows are from a light trip-hammer, delivered at high speed, only the surface of the metal will be bruised and the core not affected, thus causing the core to be coarse-grained without the proper cohesion to insure the necessary strength.

A heavy hammer descending on work which is held at the proper temperature, at a slow speed, will penetrate the mass to the center and allow the particles of metal to flow to their proper position and insure a fine grain of even texture and be uniform throughout its entire size.

Forging Large Pieces

The keeping of the heat to a good forging temperature is more difficult than in the hand-forging process, owing chiefly to the difference in the size of the piece forged, as the hand-forged piece is usually small enough for the smith to put in

the fire and reheat it the minute the temperature falls below the best forging-heat. But the hammer-forged piece is many times large enough to be handled with a crane, and is therefore liable to be kept under the hammer as long as a blow will have any effect on it.

This results in a very uneven structure, as when the metal is hot the blows will penetrate to the center, and as it cools they have less and less penetration, until only the skin is affected, and the annealing, which is resorted to afterward, cannot bring it back to the proper homogeneity, as some parts will have a denser grain than others and therefore be stronger.

Drop-Hammer Forging

When enough pieces of one shape are wanted to wear out a set of dies, the cheapest and best way of producing these in the high-grade alloy steels, is by the drop-forging process. They can then be made in one piece without welds, except in pieces which are many times longer than a section through them, and these are so difficult to keep at the proper temperature that they are usually forged in two or more pieces and then electrically welded together. The oxygen-acetylene blowpipe has been brought into use for welds of this character, as well as all other forms of welding, and as good results are being obtained with this as with electric welding.

A good illustration of this is the front axle of an automobile, which is usually forged in *I*-beam sections, 4 inches from the top to the bottom of the *I*, $2\frac{1}{2}$ inches across the flange, with the web $\frac{1}{4}$ of an inch thick, and a length of from 48 to 54 inches. These are generally forged in two halves and electrically welded in the center, but a few of them are forged in one piece, although the first cost of the dies and the liability of their breaking, owing to the axle cooling before the forging operation is completed, has made this method very expensive.

Drop-Forging or Squeezing

In the drop-forging process two methods are employed, one being the ordinary drop-forging process, which hammers

the metal into shape, and the other is the hydraulic press, which squeezes it into shape. With both of these methods dies are necessary, and these are usually made of a 60-point carbon-steel and in two halves, an upper and a lower one, they being generally parted in the center, but the shape of the piece controls the location of the parting-line.

The dies are always given from 5 to 7 degrees draft, so the forging will fall out easily, and they are left open on the parting-line from $\frac{1}{8}$ to $\frac{1}{4}$ inch, according to the amount of metal in the forging. The amount of stock is always greater than in the finished forging, so it will completely fill the die and the surplus is squeezed out at the opening on the parting-line. This fin is afterward trimmed off.

Setting the Dies

One of the first and most important points in die-forging is the setting of the dies, as the upper-half, which is fastened to the ram, and the lower-half, which is fastened to the anvil-block, must come exactly in line to produce a perfect forging.

The lower half of the die should have a current of air blowing in it that is strong enough to remove all of the scale which works off the piece being forged. The air-blast should be directed so it will not cool the hot metal being forged. Steel-wire brushes can be used for this purpose, but the air is quicker, and if well adjusted will be positive. The upper half of the die should be kept well oiled, so the scale will not stick to that. This can be done by rubbing a swab, well soaked in oil, through the die every time it is raised off the work.

Accurate Forgings

With the dies properly set and the press adjusted so the two dies will come together on the parting-line, the work can be turned out to one thirty-second of an inch of the finished size, thus making much less machine-work than by the hand-forging process, and when grinding is to be used in finishing, the work can be brought to within one-hundredth of an inch.

After forging, the pieces should be pickled in a pickling-

bath, of a diluted solution of sulfuric acid, to dissolve the oxide or scale, after which they can be submitted to a sand-blast, if a still better surface is desired.

The cost of drop-forgings depends on the number needed and the number that can be turned out at one setting of the dies, as well as on the quality of the steel used.

Forging High-Grade Steels

Thanks to the electric and autogeneous welding-process, in combination with die-forging with either the drop-hammer or the hydraulic-press, all of the highest grades of alloyed steel can be turned into forgings successfully and their strength and elongation retained; but this is almost impossible by the hand or hammer-forging process, especially if welds are made necessary by the shape of the piece. One of the alloy steels that is being manufactured into die-forgings has the following chemical composition: Chromium, 1.50 per cent.; nickel, 3.50 per cent.; carbon, 0.25 per cent.; manganese, 0.40 per cent.; silicon, 0.25 per cent.; phosphorus, 0.025 per cent.; sulfur, 0.03 per cent.

In the annealed state this shows the following physical characteristics: Tensile strength, 120,000 pounds per square inch; elastic limit, 105,000 pounds per square inch; elongation in 2 inches, 20 per cent.; reduction of area, 58 per cent.

When properly heat-treated, that is quenched in oil and drawn, these characteristics become: Tensile strength, 202,000 pounds per square inch; elastic limit, 180,000 pounds per square inch; elongation in 2 inches, 12 per cent.; reduction of area, 34 per cent.

Effects of Alloying Materials

Chromium produces a mineral hardness in steel, and steels containing this alloy are difficult to forge, but if the temperature is kept above 2,200 degrees F., or a bright yellow, and never allowed to fall below this it can be forged successfully.

This would require frequent reheating, as the melting-point

is 2,500 degrees F., and it cannot reach this temperature. With this steel it is best to make the dies with shorter steps between the different pairs than for ordinary carbon-steels.

Steels containing nickel are more easily forged, but they must be handled carefully, owing to its tendency to produce fissures.

The vanadium steels are more easily forged than either of these, and if due care is taken to increase the heat gradually at first—that is, this steel should not be plunged into the heat all at once—no trouble will be experienced afterward.

Silicon in small percentages does not affect the forgeability of steel, but in large amount it gives steel a fibrous grain, and is therefore used principally for springs. But in the last few years this steel has been forged into gear blanks to quite an extent. In this case the blanks should be made in the form of forged rolls, and not cut from bars, in order to avoid the fibrous structure.

The aluminum, tungsten, titanium, manganese and other alloyed steels are not used to any extent for forgings, as those before mentioned show superior qualities, and some of the last named are much higher in price.

Hydraulic Press Gives Best Results

The inferior quality of many die-forgings is undoubtedly due to the drop-hammer process, as this has a tendency to produce only a bruising effect, owing to the top die descending at a high rate of speed and delivering a light blow which has no penetration. The hydraulic press, on the other hand, produces forgings of a far superior quality, because it slowly squeezes the metal into the shape of the dies, thus allowing it more time to flow into place and assume its new shape, and therefore making it more uniform in quality with a great deal lower degree of internal strains. To remove the internal strains caused by working the metal, all forgings, no matter how they are made, should be annealed before using, as the shocks to which the forging may be submitted will concentrate at the point where these internal strains are the strongest,

causing it to break at that point. The results are very similar to the machinist notching a bar in order to break it off.

Heating Too Suddenly

Many poor forgings are also turned out by raising the temperature of the metal too suddenly. Certain molecular changes take place in the heating of all steels, and of the alloy steels in particular, which are liable to cause fissures in the core of the metal, and these may not show in the finished product, as they do not always break through the skin or outer shell of the forging. Thus, by heating suddenly, the outer shell becomes red before the core has had an opportunity to absorb any heat and the outer shell expands, causing great strains on the core of the piece.

In the case of a high percentage of nickel these fissures become more pronounced than with the other alloys.

At a temperature of about 600 degrees F., or a bright blue, most steels lose their ductility and are not fitted to resist strains imposed upon them by the differential expansion of an unevenly heated metal. Therefore the rise in temperature from the normal to 600 degrees should be a gradual one, but after this it may be brought up to the forging heat as quickly as is desired.

CHAPTER IV

DROP-FORGING AND HARDENING PLANTS:—DESIGNS, FUNDAMENTAL CONDITIONS, AND EQUIPMENT INVOLVED IN THEIR ATTAINMENT

The Drop-Forge and Hardening Plant

THE design and equipment of the drop-forge shop and the hardening plant, are subjects frequently entirely neglected in the first design, and almost always slighted in the erection of the modern manufacturing plant. This neglect is largely due to conservatism, but at the same time it cannot be denied that in few places will careful design or a small outlay of money show greater satisfactory results in finished metal parts, or quicker returns from the amount of money paid out. To install a finely and expensively equipped tool and die department, and then a hardening department consisting only of a few coal and gas fires and tubs of fresh water, shows lack of proper thought and is inconsistent. In this chapter the object is to illustrate and describe types of each department, showing what constitutes the best modern practise, together with much detail matter bearing on such departments in general.

Drop-Forge and Hardening Departments Under One Roof

These two departments, being of the same general type, should preferably be combined under one roof. In a building for this purpose, ventilation is of greater importance than light. A good form of building is from 60 to 70 feet high under the trusses, with roof pitched not less than 30 degrees, and a ventilating-monitor of at least 15 feet wide extending the entire length of the building. Windows throughout should be of the American type, with sliding-sashes.

In the hardening-room, all windows should be protected

from excessive light by slant shutters, the slats being set at 45 degrees and about 3 inches apart, adjustable for about 1 foot at the top. This arrangement gives a subdued light, allowing the hardener to distinguish his colors with a greater degree of accuracy. The slight adjustment at the top is sufficient to keep the interior bright and evenly lighted, regardless of the outside conditions. One 16-candle-power light, hung 7 feet from the floor, should be provided for every 150 square feet of floor-space in this department.

The engraving, Fig. 148, shows the plan of such a building as primarily laid out as part of a large manufacturing plant. The equipment shown in Fig. 148 is laid out on the basis of minimum clearance desirable in the forge-shop.

Location of Die-Sinking Department

The die-sinking and inspecting departments are set at the end of the building, both to insure better light, and to be farther away from the jar of the larger drop-hammers. The jar in a department so located is sufficient to materially affect the quality of the work, provided the partitions are of brick and extend well below the floor-line. The rough stock for dies is to be brought in at the door near the end of the building, planed up dovetailed—to fit the die-blocks—in ten-foot lengths, and then rough-sawed to size desired in a power-hack saw. The finished dies are to be stored in the fireproof vault assigned to them, on racks with shelves 6 inches wide. Thirty-inch passage ways, being sufficiently wide to admit trucks, are allowed between the racks.

Board, Steam, Helve, Trip, and Drop Hammers

In the modern-sized shop, at least, it is best policy to install comparatively large drop-hammers, on account of their broader range of utility. The general practise is to install board-hammers no size smaller than 400 pounds, and to install steam-drops where the work requires sizes larger than 1,000 pounds. The steam-drops in large sizes have the advantage of being able to break down their own work, but on small parts the

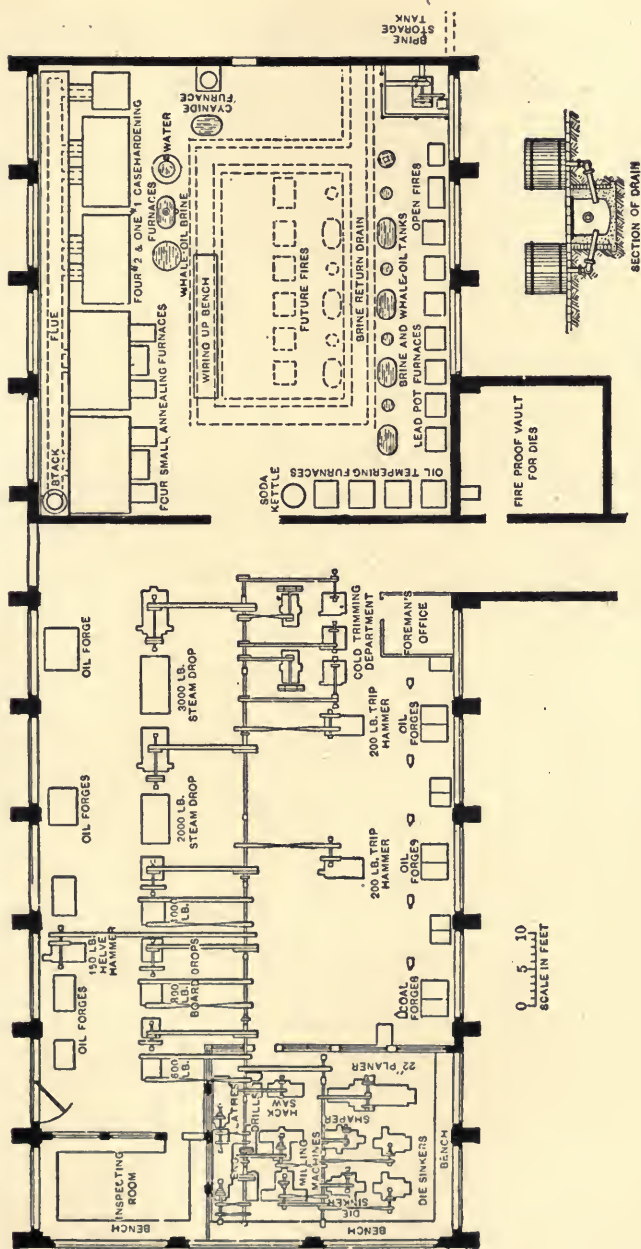

FIG. 148.—Plan of modern drop-forge and hardening plant.

experience has been that many forgings are spoiled by catching in the quick stroke.

In the illustration, the larger board-drops have been set in conjunction with a helve-hammer, so arranged that it may break down for two of them. This result may be obtained equally well by setting the helve-hammer between two drops and faced the same way, but with the anvil-block set about 3 feet in front of the base-line of the drop-hammers, thus permitting the blacksmith to swing his stock directly from one to the other.

The largest hammers are set nearest the main crossing or passageways, to make possible less travel for the larger stock and the finished product. The forgings are, of course, hot trimmed in the trimming presses and by sprue cutters set in conjunction with each hammer, but before going to the machine-shop they are accurately trimmed to the size required for their reception into their various jigs and fixtures, in the presses of the cold trimming department.

The two trip-hammers are used in conjunction with tool-dressing and general work. The two blacksmith-forges near the die-sinking department are used for general work during the day, and for night and overtime work when the main shop is not running. They are blown from an overhead blower, motor-driven, and are hung from the trusses, their exhausts being taken out through the roof. With the exception of these two fires the use of fuel-oil is universal throughout the entire shop. This subject will be further discussed later. Both the forge and hardening departments should be in general charge of one man whose office is centrally located between them, but each should have a separate subforeman.

Layout of Hardening Department

The general layout of the hardening department is self-explanatory, but the details may require explanation. In front of the small open fires, lead pots, etc., with 43 inches clear space, is set a row of brine and whale-oil tanks, alternating, one of each kind being sufficient for two fires.

These regular brine-tanks are built of 2½-inch Southern pine, and elliptical in shape, being 30 inches wide, 4 feet long, and 30 inches deep, with a capacity of 120 gallons. The brine is circulated through these tanks, entering at the bottom through a 1¼-inch brass pipe controlled by a gate-valve, and overflowing at the top through a 4-inch cast-iron soil-pipe. The required rate of circulation for each tank, to keep the brine sufficiently cool for the best results in hardening, is 50 gallons per minute.

Centrally located in front of the No. 2 case-hardening furnace is a brine-tank of the same size as described above, a

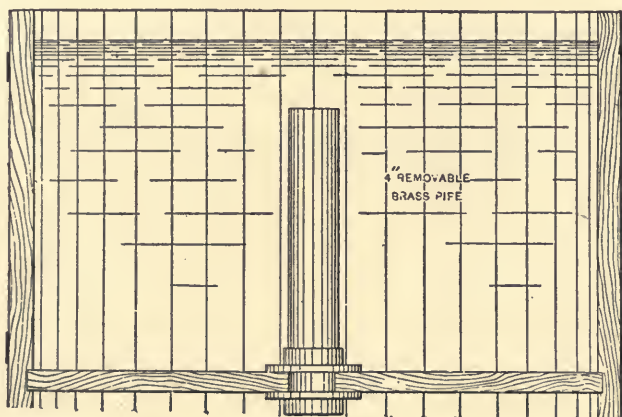

FIG. 149.—Brine-tank.

vertical section of which tank is shown in Fig. 149. Brine is admitted through the 4-inch brass pipe in the center of the tank. This pipe extends within 6 inches of the brine-level, and is readily removable by hand, being loosely screwed into the coupling at the bottom. The brine entering through this pipe under pressure, forms a dome above the main level, which dome is used for the purpose of dipping the face of the drop-hammer dies, after which the dies are reheated slightly and plunged all over. By using this method of dipping the face, every corner and crevice of the die is struck at once, thereby preventing unequal cooling and cracking. As the

inlet pipe is readily removable, the utility of the tank as applied to general hardening is in no way limited. One hundred and fifty gallons per minute should be temporarily available for this tank. A 5-inch cast-iron soil-pipe takes care of the overflow.

A 4-foot diameter whale-oil tank, one regular brine-tank, and a portable fresh-water tank complete the equipment required for the case-hardening furnaces. These tanks are served by a crane. The portable fresh-water tank is 30 inches diameter by 30 inches deep, and when not elsewhere in use is set in a concreted depression in the floor, 4 feet diameter by

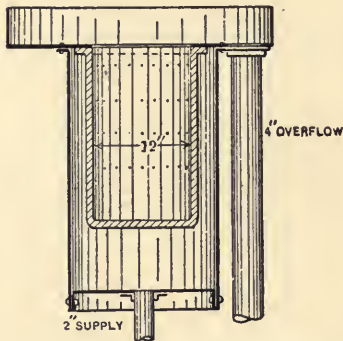

FIG. 150.—Special brine-tank.

6 inches deep, and this depression is drained through a screen through a 4-inch tile drain. The chief use of this tank is for water-marking screws and other small parts. The tank is drained at the bottom through a 2-inch spigot. A large part of the black bone used is caught by the screen in the depression, from which it may be readily shoveled out.

Even with this precaution, however, it is desirable that the drain run with as steep a pitch as possible direct to the catch-basin, both to prevent stoppage and to make easy the cleaning out, should stoppage occur. The drain will surely give trouble if laid with many turns. On opposite sides of this tank are lugs and hooks to receive poles by which two men carry the tank about the job, wherever its use is required.

In front of the open fires is a special brine-tank used for hardening cutters, reamers, etc. A section of this special tank is shown in Fig. 150. The brine is admitted at the bottom through a 2-inch brass inlet-pipe, and spouts through a large number of $\frac{1}{8}$ -inch holes drilled in the 12-inch cast-iron inner tank. The combined areas of these holes is designed to be

about 20 per cent. in excess of the area of the inlet-pipe. A 4-inch cast-iron soil-pipe takes care of the overflow. The advantage claimed for this tank is that the brine, spurting through the small holes on all sides, strikes all the teeth or flutes of the cutter or reamer at the same time, thus tending to prevent cracking.

A 5-inch by 4-inch centrifugal circulating pump, set in the pit in the corner of the building and driven by a 15-horse-power motor, supplies the brine system. The required pressure which must be kept on this system to secure good

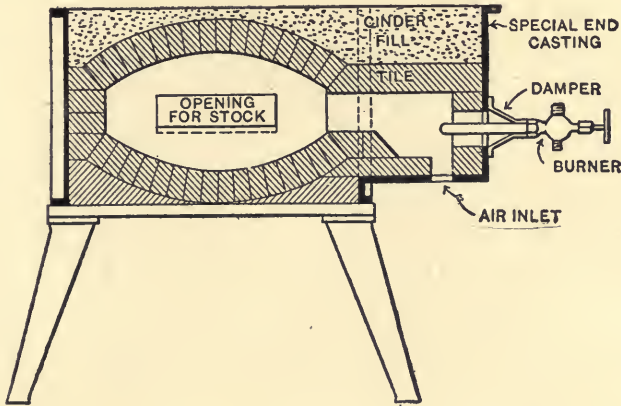

FIG. 151.—Refitted blast-furnace for oil fuel.

efficiency is 15 pounds per square inch. The pump is set sufficiently low to be always primed from the storage-tank built in the ground outside the building. That brine may be kept sufficiently cool in the summer months, this storage-tank must have a capacity equal to a fifteen-minute supply for the entire system when all tanks are in operation at full capacity. The brine overflow from all serve-tanks is returned by gravity to the storage-tank through the open drain shown clearly in Fig. 148.

The regular oil-tanks are 20 inches diameter by 2 feet deep inside, but the shell is made 30 inches high to bring their tops at the same level as the brine-tanks. The cooling appar-

atus consists of a coil of $\frac{1}{2}$ -inch brass-pipe through which a part of the factory service water is circulated. The large 4-foot oil-tank is of the same depth and is cooled through a 1-inch brass coil. It is not necessary to keep the oil as cool as the brine. A 2-inch by 3-inch belt-driven centrifugal pump supplies the circulating water. Certain concerns cool their oil by circulating it through a series of trombone coils placed in the monitor of the hardening-room, but the practise has never appealed to the best experts. The expense necessary is comparatively great, the oil makes hard work for the

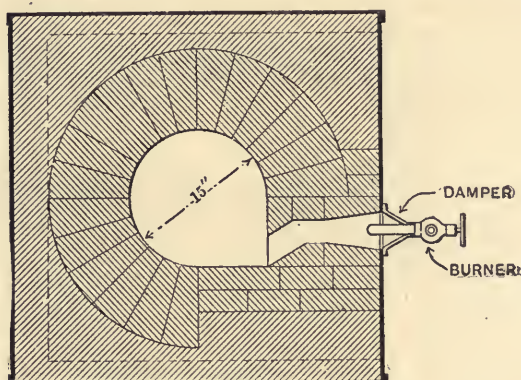

FIG. 152.—Refitted lead-pot furnace for oil fuel.

pump, and then the main heat from the building must pass out around these coils if so placed.

Advantages of Oil Fuel

Having in a general way described the equipment of each department, let us return to the question of fuel. The first considerations controlling the efficiency of such departments are of course the case of regulation and heating capacity of their fires. It is in this regard, even more than in the reduction of fuel costs, that the greatest reduction and economy is attained by the use of fuel-oil. The reasons are at once clear. The blacksmith's time may be entirely given to his work in hand, since once the valves are properly adjusted they require

little or no attention, and an even heat is positively assured. No labor is required to bring coal or take ashes away from the forge, and when no work is being done no fuel is required. If the flame is run a little on the yellow there is absolutely no scale. The cleanliness of the fire renders it especially adapted to such work as welding, etc. For the departments under discussion, the best practise is a air-pressure system to those using steam, the preference being due chiefly to the fact that these departments are generally somewhat isolated from the source of steam-supply. Of the air-pressure systems, those using the

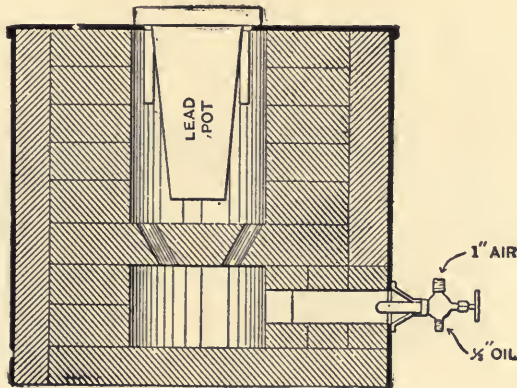

FIG. 153.—Refitted lead-pot furnace for oil fuel.

lowest pressure consistent with the best efficiency are evidently the most desirable. Excellent systems are now on the market, using from 8 to 10 ounces pressure. These systems require, however, furnaces of rather special design, the most efficient having ample combustion of mixing chambers in which the oil-spray is combined with a primary air-supply and volatilized before being admitted to the main chamber, where the stock is to be heated. In a plant where the installation is to be entirely of new forges, a carefully selected system of this type is ideal. In many cases, however, it may not be thought desirable to entirely discard such equipment of coal-burning forges as may be on hand. Where such is the case but small outlay is required to make the necessary alterations to permit

them being used in conjunction with a moderately low-pressure system. By this I mean a pressure of about 2 pounds per square inch, which can, of course, be readily discharged by the ordinary "high-pressure blower," without requiring the installation of any air-compressor, as is of course necessary with a system using from 15 to 18 pounds pressure.

Refitted Coal-Forges and Furnaces for Fuel-Oil

In fitting coal-forges and furnaces to use fuel-oil, it is desirable, as far as possible, to give the spray a whirling motion

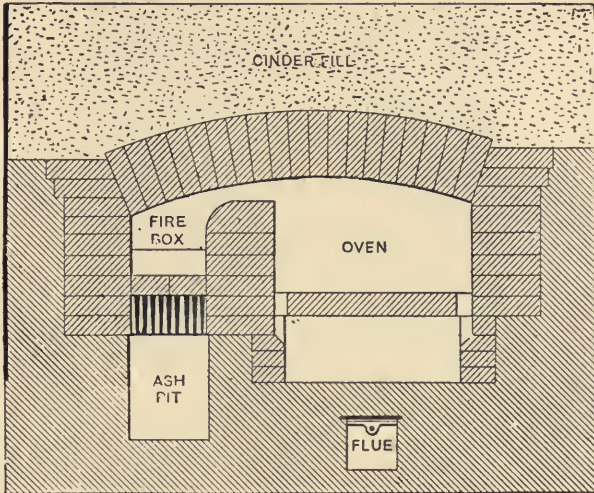

FIG. 154.—Refitted Brown & Sharpe case-hardening furnace for oil fuel.

which tends to more completely vaporize the oil, and also makes a much less noisy flame than is the case where the oil strikes against flat surfaces. In the latter case, where the oil strikes flat against the white hot tile, it causes what appears to be a series of rapid explosions, sufficiently loud in a large shop to be a source of annoyance.

Fig. 151 illustrates a method of refitting a common blast-furnace. Common arched firebrick and skewbacks are used, and a few special tiles which may be readily ground to form on the

common grindstone. Common red brick may be used as backing. A special casting is required, the end of which may be made to bolt onto the original side-castings. In very large sizes it is sometimes advisable to install a burner at each end of the forge, which arrangement is very satisfactory, and gives an intense heat at the center of the fire-box.

Figs. 152 and 153 show horizontal and vertical sections of the common form of lead-pot furnace refitted. Either wedge or cupola brick may be used. Two courses from the bottom tile, and forming the top of the mixing chamber, is a tile

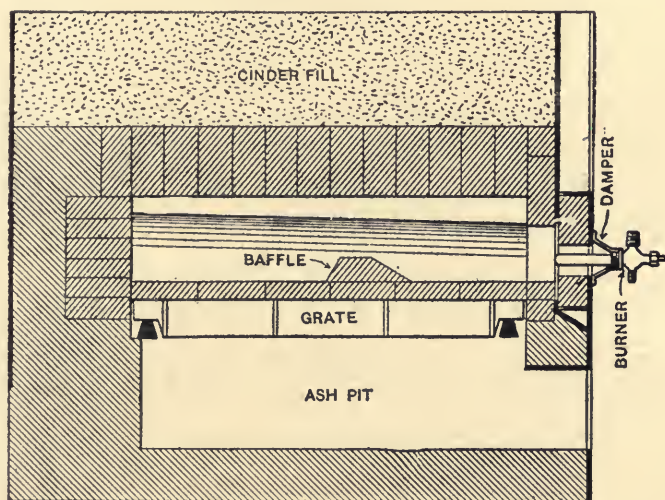

FIG. 155.—Refitted Brown & Sharpe case-hardening furnace for oil fuel.

through which are drilled, at an angle, six $1\frac{1}{2}$ -inch holes. For this operation a common star-drill may, with care, be used. In the top two [courses, four bricks each are omitted at 45 degrees for vents. As before, the firebrick is backed up with common red brick.

Figs. 154 and 155 show cross-sections and longitudinal sections of a refitted No. 2 Brown & Sharpe case-hardening furnace. In this case the coal-gages are left in place and simply paved with fire-brick laid on their sides. A 3-inch fire

tile, ground to form shown, is centrally located in the firebox to act as a baffle. If the furnace is to be set up new for use as fuel-oil, it is desirable that the bridge-wall be sloped as shown, to leave an opening at the back of 2 inches over the wall, and 4 inches at the front. The reason for the construction is to counteract the tendency of the heat to drive to the back of the oven. This tendency exists, but it is not marked, that in cases where the furnace is already set up it hardly pays to rebuild the bridge-wall. A special fire-door casting, designed to take the burner, must take the place of the former vertical sliding-door. These few examples will give the reader a general idea of the changes necessary to remodel an installation of coal furnaces.

Arrangement of Piping

In the two departments under discussion, the oil is supplied to all furnaces through a $1\frac{1}{4}$ -inch wrought-iron pipe-main, making a complete closed loop around each department in order to keep the pressure even. A 1-inch steam-pipe must be laid with it to keep the oil from congealing in cold weather. These two pipes should be laid preferably in the ground itself and not in a trench, and should never be laid above the floor, the reason being that the gases from all petroleum distillates are heavier than air, and will run to the low parts of the floor or the trench. These gases, though not themselves explosive, may become so if combined with a larger proportion of air.

The air-piping should be suspended overhead with outlets looking down into the risers from the oil-mains. The speed of the air in these pipes should not exceed 15 feet per second in the first installation, which will permit of about 30 per cent. increase, due to growth, without the speed becoming excessive. A rule-of-thumb measurement sometimes used is that the area of the air-pipe shall equal six times the area of the jet, but the foregoing method is much safer for the computation. To facilitate calculations, the following notes will prove of interest.

At 2 pounds pressure there will be required at the blower

roughly about 1,000 cubic feet of air per minute per gallon of oil-burner.

Blast furnaces burn per day of ten hours approximately 0.15 gallon of oil per square inch of horizontal area of fire-box.

Open fires for hardening, as above, 0.025 gallon.

Lead pots, oil-tempering, case-hardening and annealing furnaces, 0.05 gallon.

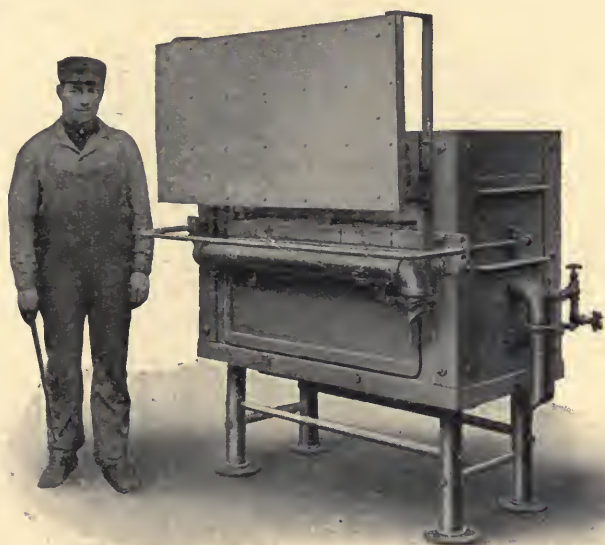

FIG. 156.—Single opening forge for end heating.

About 10 horse-power is required to transmit 1,000 cubic feet of free air against a 2 pounds pressure.

From the foregoing, a close estimate of the size of the required blower and the horse-power needed to drive it may be obtained. Included in this estimate must be a figure on the amount of air required to blow the drop-hammer dies. The blow-pipes required are one $\frac{1}{2}$ -inch pipe with flattened nozzle for each small drop and trip-hammer, and two of the same size for the larger drop-hammers. As the use of these blow-pipes is rather intermittent, this figure is generally in the

nature of an off-hand estimate, based on the judgment of the engineer.

Finishing Department

In the finishing department the following recommendations should be followed, in order that the best results both as to economic and efficient production and safety and contentment of the help may attain.

Emery dust should be exhausted fully from the grinding department, as such dust is detrimental to health and effi-



FIG. 157.—Double opening forge for center heating.

ciency, the floors of the shops and similar departments should be covered with iron plates, which promote cleanliness, both for men and machinery. In a properly equipped and operated forge-shop, individual chimneys for each fire and usual facilities of ventilation by windows and by overhead fan lights, clean, fresh air should be drawn in from a point high above the roof by powerful fans and distributed through each forge-building until it descends over each man's head, through a flexible pipe under his control, thus assuring an abundance of

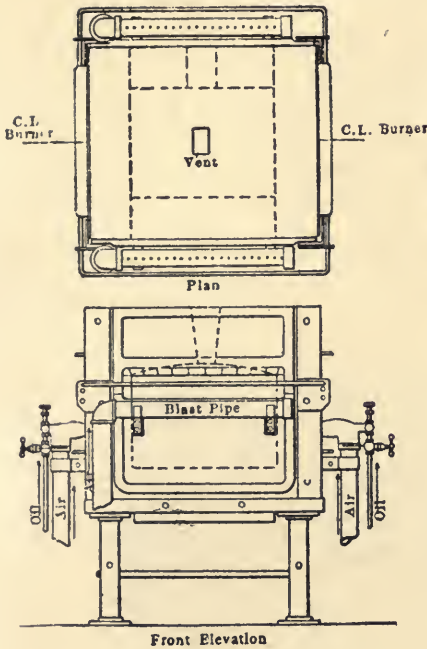

FIG. 158.—Double opening forge.

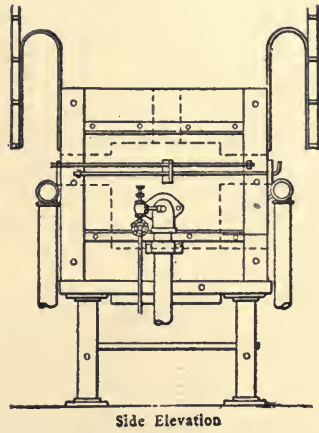

FIG. 159.—Double opening forge.

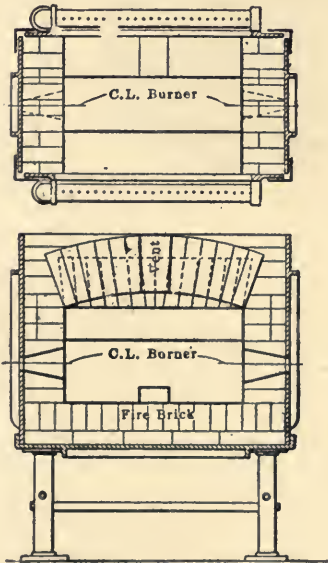

FIG. 160.—Double opening forge.

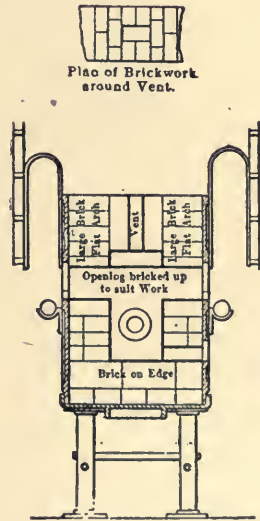

FIG. 161.—Double opening forge.

cool, pure air. In one forge, say where there are over thirty furnaces, running under forced blast, it will be found, if the above is carried out, that even in hot weather the cooling system will cause the men to work steadily, the output will be kept up, and the shop will not be compelled to shut down on extremely warm days, as is usually the case. This system will please both the men and the owners.

While the above conditions outlined are essential to any first-class drop-forge shop, they are as nothing compared with

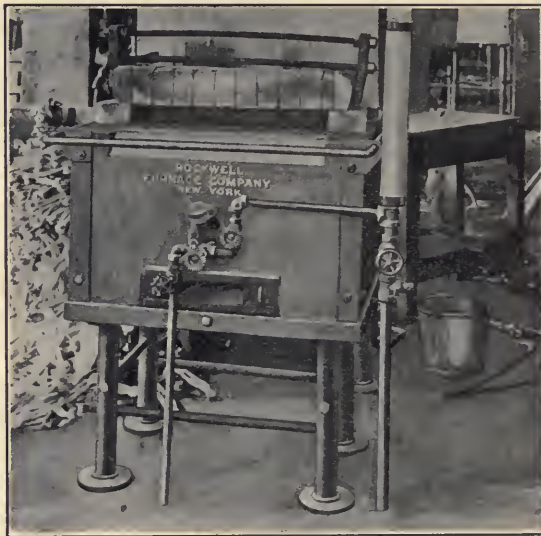

FIG. 162.—Adjustable top-slot oil-forge furnace.

the fact of just and fair treatment of help. Wages should be advanced voluntarily, and not when a general demand is made for advanced pay. Never make a general reduction of pay. Those who know factory conditions from the ground up will agree that the piece-work rates should never be cut until competition makes it absolutely necessary.

Oil-Burning Forges and Heaters

In the steady advance in the improvement of machinery and apparatus that has been going on for years, the old coal

or coke fired blacksmith's forge with its accompanying dirt, smoke, gases, and foul odors, and its handworked bellows, has given way to furnace forges that are practically as clean as the machines in the machine-shop.

In making the much-needed improvements the fuel has been changed, and the coal, with its dirt, smoke, etc., has been abolished by substituting gases of different kinds and oil in its



FIG. 163.—End-heating forge furnace.

place. As well as making the forges clean and pleasant to operate, the change has made a considerable reduction in the fuel bills. Fuel-oil, which is the product used in the forges herein described, has proved itself to be one of the cheapest fuels, and has thus supplanted the coal-fired forge in many places.

These styles of forges and furnaces have another advantage over the coal-fired forge, which is that they can be heated to

any desired temperature, and that temperature maintained permanently by setting the valves which admit the oil and air to the burner. This is a very desirable feature of the oil or gas fired forges, and one that could not be accomplished with the old forge.

Single and Double Opening Forge Furnaces

In Figs. 156 and 157 are shown two styles of the most common type of forge-furnaces, one of which has the opening on one side only, and is used for heating small pieces, or the ends of larger ones. The other has an opening on both sides, opposite each other, so that long bars can be shoved in through

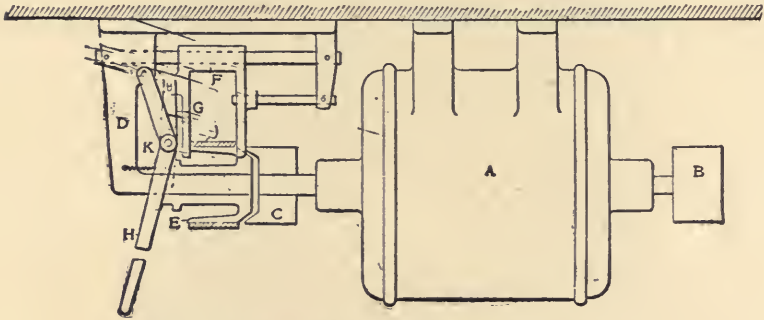

FIG. 164.—Method of installing apparatus.

and heated in the middle. This opening is left 5 inches high on this size of furnace and it can then be bricked up to make the opening small enough to suit the work. Burners are located on each end of these forges, so that the chamber will have a uniform heat its entire length.

A double steel-plate is located above the opening to protect the operator from the heat of the furnace, and in conjunction with this an air-blast is sent through the pipe and comes up through the floor and runs along the entire front of the furnace immediately below the opening. This air-blast drives the heat which might come through the opening up the back of the steel-plate, so that the operator can work in comfort.

The details of the construction of the double-opening forge are shown in Figs. 158 to 161. The single-opening

forge is practically of the same construction, with the exception that the one opening is closed up with fire-brick and forms the back of the furnace, while the sheet-metal heat-protector and air-blast are removed from that side of the furnace.

Top-Slot and End-Heating Forges

For work which cannot be readily handled in the above forges an adjustable top-slot furnace, like the one shown in Fig. 162, is manufactured. An adjustable clamp for holding

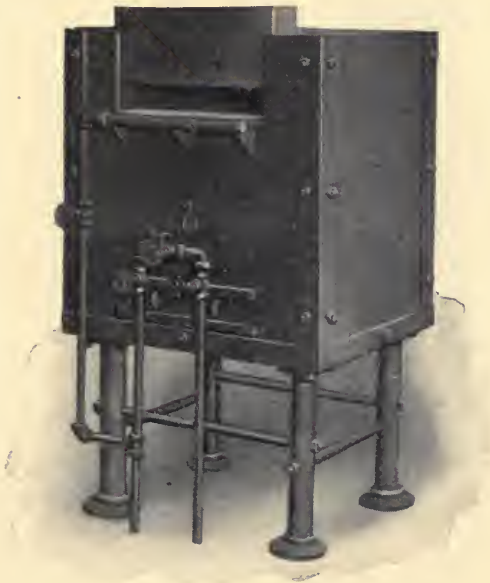

FIG. 165.—Tool-dressing forge-furnace.

the brick which covers the opening is furnished with this forge, and the opening can be made any size suitable for the work. As will be seen, these forges are simple in construction, easy of control, taking practically none of the operator's time for that part of the work, and are made so that nearly any kind, size, or shape of piece may be handled.

In Fig. 163 is shown an end-heating furnace fitted with a door which can be raised or lowered to open or close the furnace.

Installation of Forges

In Fig. 164 is shown the methods of installing these furnaces with their apparatus for oil and air. As will be seen, the two pipes are laid under the floor, one to deliver the oil and the other the air-blast, and the furnaces connected up to these.



FIG. 166.—Wire-brazing furnace.

While this is the best method, when conditions are such as to make it desirable, these pipes should be carried to the ceiling instead of under the floor. Gases, such as natural-gas, coal-gas, water-gas, producer-gas, etc., can be used in these same furnaces as readily as oil by changing the burners to those that are suitable.

The most important thing is to see that they are properly installed, so that the air and fuel pressures be steady, uniform

and voluminous enough to give the forges their proper temperature and maintain it at the desired point. This, of course, varies with the kinds of material to be heated.

Where accurate temperature control is not necessary, and pressure under 14 ounces will suffice, the steel fan or positive blower, that will give the proper volume, will maintain a uniform pressure. Where the pressures from 2 to 5 pounds are

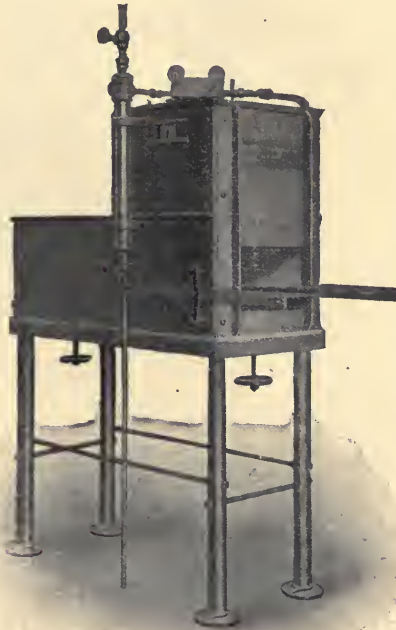

FIG. 167.—Tube-brazing furnace.

required, the positive blower is used, and when an air-pressure above this is necessary the compressed-air plant will be needed. In some cases good dry steam will give better results and effect a saving in fuel. The quantity of fuel required varies with the temperature, material treated, and speed at which it is handled, but the fuel-pressure must always be uniform. For the oil 5 pounds pressure is sufficient.

Burners .

The burner to be used is an important factor in the economical production of work with these forges, and therefore it is not practicable to have one burner that will do all kinds of work. Whether high or low pressure air or steam is to be used for the blast, makes a difference in the kind of burner



FIG. 168.—Gas-fired ladle-heater.

that should be used to get the greatest efficiency with the minimum of fuel consumption, as well as the temperature that it is necessary to maintain in the forge, and the nature of the work that is to be done.

By Fig. 165 is shown a tool-dressing forge-furnace that has been designed especially for shaping up lathe or planer tools or pieces of a like character and size, whether they be made of high speed or carbon steels.

Brazing Furnaces

A fine line of brazing furnaces is of the type shown in Figs. 166 and 167. Fig. 166 shows the wire-brazing furnace and the crank to the right operates a clamp that holds one wire. A clamp is also located on the opposite side of the furnace, so that the two wires can be held in perfect alignment if desired, or the other wire can be held by the

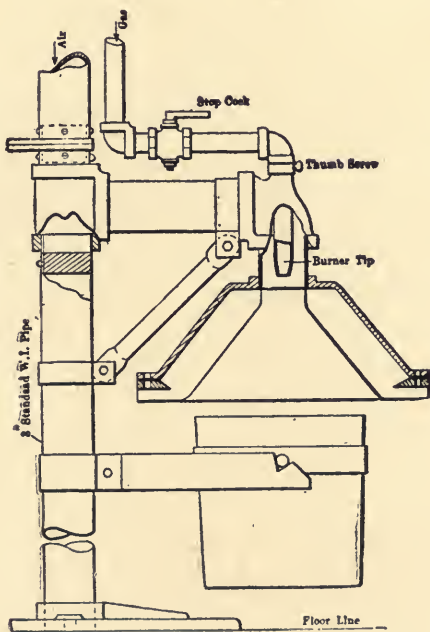

FIG. 169.—Details of gas-fired ladle-heater.

operator. A trolley-wire can be brazed every three minutes with this style of furnace, the necessary heat coming out through a hole in the top of the furnace.

The tube-brazing furnace shown in Fig. 167 is designed for brazing brass, copper, or steel tubes. The burner discharges a ribbon of clear hot flame from the top, down upon the tube, with an inclination toward the rear; the place to be brazed being near the front in full view of the operator. The

bottom of the chamber may be raised or lowered to accommodate different sized tubes by the small wheels and screw underneath the furnace. Valves for controlling the temperature are located within easy reach. Thus the operator can regulate the fire to suit his work and draw the tubes forward without changing his position. The escaping gases pass out at the rear end and warm up the incoming tubes, as well as making it comfortable for the operator by conducting them away from the front.

Heaters

In Figs. 168 and 169 is illustrated a ladle-heater that is simple in design, does not take up much room, and yet does the work perfectly. It can be used with either city or natural gas. Fig. 169 is a line cut showing details of construction of the same.

CHAPTER V

DROP-HAMMERS: THEIR DEVELOPMENT, WEIGHTS, FOUNDATIONS, AND DIES

The Development of the Drop-Hammer

FROM 1847 to 1862, among the green hills of the State of Vermont, there was located one of the best equipped plants for the manufacture of machine-tools in this country. It was there, in the years 1854 and 1855, that most of the machinery was built for the manufacture of the then celebrated Enfield rifle for the English Government, on the interchangeable system. Previous to that time they made their fire-arms on the "cut and try" plan, or by what we would term in this country hand-work. The parts were made in different shops; for instance, one manufacturer was skilled in making the barrel; another, the stock; another, part of the lock, and so on through the list. The various parts were assembled at the Tower of London, and it was there that the "cut and try" plan commenced, filing a little here, clipping off a little there, with several trials before the parts would go together satisfactorily.

On the introduction of American machinery all this was changed, for it was found possible to machine the pieces of the arms so that the same kind would be exact duplicates of each other; consequently the cost of production was reduced and the quantities in a given time increased over the old method.

To America is due the credit of introducing the interchangeable system in the manufacture of firearms, sewing-machines, watches, etc.

It was necessary to have uniform forgings, so that they could be handled in special fixtures adapted to the different

parts. The art of forging in dies at that date was the weak point. Drop-hammers had not come into use, and all the forgings were made by the old hand swedging processes, represented by Fig. 1. A base of cast iron, with suitable opening in the top for keying the guide-stock and lower die was set up, the upper die being made to work freely up and down in the guide-stock. In the faces of the two dies were cut the forms of the parts to be forged. The power used was hammer and sledge, wielded by the smith and helper:

So far as can be learned, drop-hammers were first used by Colonel Samuel Colt, about the year 1853, in the manufacture of the celebrated revolving firearm that bears his name.

The hammer of the Colt drop was raised by a vertical revolving screw. In the first year of the Civil War, Golding & Cheney obtained a United States patent on a drop-hammer, the principal feature of which was raising the hammer by a leather belt between friction-rolls. These friction-rolls are in use to-day on what are considered the best hammers for drop-forging. In other respects there have been great improvements. Some of the latest of these improvements are explained in the following.

Counterbalanced Treadle

This treadle is made from one piece of steel-forging. The advantage of this construction is that it does not become "shackly" from wear, and when the pressure is put on one side the opposite side acts simultaneously, and the mechanism on either side of the machine does its work as it was designed to do. Instead of springs to hold the treadle in a raised position, counterbalance is provided which runs across the back of base and is attached at either end to levers whose fulcrums are pine-driven into the sides of the base, the short ends of the levers having projecting points extending underneath the sides of the treadle and holding it in the raised position desired.

The improvements claimed for the counterbalancing treadle are that the pressure required is the same at the start as

at the finish of the movement of the treadle, and that the construction is such that repairs are not frequently needed, as in the cases where the springs or pulleys and chains are used.

Compound Lever Device for Operating the Lifting or Head Mechanism

This device was designed with a view to lessen the shock of the blow given to the friction-bar by the hammer when in operation. It consists of a clamp on the friction-bar, having a projection on the inner side, which acts as the fulcrum of the lever, whose short end is a fork which engages with pins projecting from the left hand upright, and whose long end is actuated by a pin in the hammer, which pin is placed as near the right hand side of the hammer as is practicable, in order to enable the long arm of the lever to be made as great a length as possible, thereby reducing the speed of the movement given to the friction-bar, and incidentally the shock of the blow.

All this tends to obviate the necessity of repairs, as it reduces the tendency of the friction-bar to become crystallized, and it imparts to all the friction mechanism a moderate, easy movement, which is conducive to the durability of that part of the machine.

Another feature of this device is the ease with which it is adjusted for the different heights from which the hammer falls. There is only one nut to turn, and when this is loosened the clamp is perfectly free upon the bar and will drop from its own weight, or can be raised with one hand. This one nut is sufficient to hold the clamp in place, as the latter is not subjected to the sharp blow as in the old method.

Jointed Swinghead Construction

The main idea of this construction is to lessen the expense of repairs. The two sides of the head are connected by a heavy web at the bottom edges, through which there is a rectangular hole to accommodate the board. The upper halves of the two sides are fastened to the main head-casting

by a hinge-joint at the rear, and are primarily held in place by the small swivel bolts, the same as used on a lathe center-rest, and incidentally by two of the head-bolts which pass through the upper and lower parts as well of the head and through the top of the uprights.

On both sides of the machine, running horizontally through the upper part of the uprights, through the web of the lower part of the head and into the rectangular hole in the latter, good stout bolts are used which hold the upper part of the machine rigidly together, and relieve the head-bolts proper



THE OLD WAY.

FIG. 170.—The first “interchangeable” blacksmith.

from all shearing strain and also obviate the elongation by wear of the holes in the uprights. The eccentrics are made of steel-castings, which are stronger and more durable than bronze or gun metal. These are chambered and babbitt-lined, this lining being easily replaced when worn out. The sliding rear boxes for adjusting the friction are operated in the usual way.

Paper Pulleys

Experience has shown that iron pulleys are not reliable for drop-hammers. They become crystallized and break, and some one is likely to get hurt. Wood pulleys with iron hubs

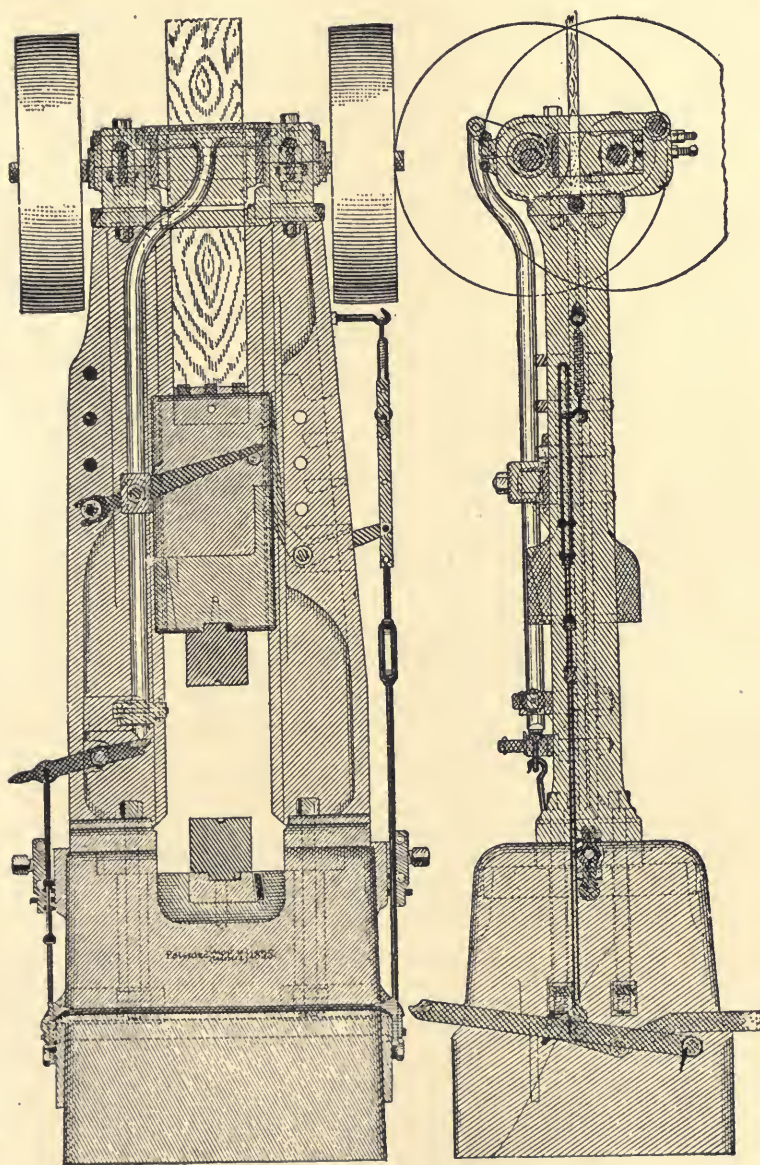

DROP HAMMER CONSTRUCTION.

FIGS. 171 and 172.—Sectional views of drop-hammer.

are very good, but the compressed paper pulleys give the best results and satisfaction. They are light as compared with their strength, are elastic, and give excellent belt surface.

Method of Fastening Board in Hammer

An oblong cavity, from 4 to 8 inches long and about 5 inches deep by $1\frac{1}{2}$ inches wide, is machined in the top of

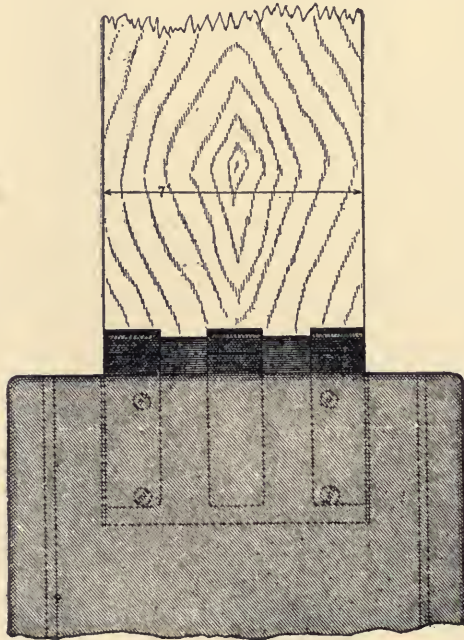

FIG. 173.—Board fastening.

the hammer. That side of the cavity which is toward the back of the hammer has a bevel of about 15 degrees, the cavity being smaller at the top than at the bottom. The front side of the cavity being straight, the rear side of the lifting-board has a bevel corresponding to that in the rear side of the cavity, a steel-plate placed against the front side of board, and two or three steel wedges lightly driven with a hand-hammer between the board and the front side of the cavity. At every blow of

the hammer, when the machine is working, these wedges become tighter and the board more firmly held.

Foundations:—Ratio of Base as Compared with Weight of Hammer

There seems to be a variance of opinion in regard to the proper foundations for a drop-hammer. Several articles have appeared in the technical journals in regard to same. Several favor a rigid, rocklike foundation, and others favor an elastic construction. It seems to me that the weight of the base of the machine, as compared to the weight of the blow given by the hammer, should have more or less consideration in determining the construction of the foundation. It is apparent that if a man tried to do some hand-forging with an ordinary flat iron held bottom up between his knees for an anvil, the result would not be altogether satisfactory, but if it were possible for him to hold a piece of iron weighing, say, 400 pounds on his knees, he would do more execution with his hammer and in addition could stand some pretty strong blows from his helper's sledge. From this illustration I argue that if the base of a drop-hammer could be made heavy enough, no foundation whatever would be required. The inertia of the mass of metal would be sufficient to absorb the effects of the shock imparted by the blow of the hammer.

The cost and difficulties of handling, however, make such an arrangement out of the question. Within the past years an increase in the weight of the bases of drop-hammers has been a move in the right direction. In deciding this point, a certain ratio between the weight of the hammer proper and the base is considered. In former years the ratio of 6 to 1 was considered sufficient. This was increased by some machine-

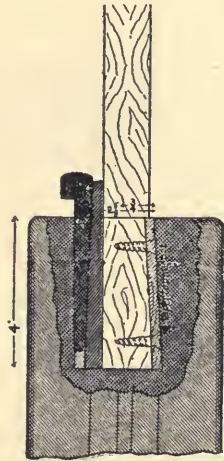

FIG. 174.—Board fastening.

builders to 10 to 1, and now the most modern practise advocates a ratio of 15 to 1.

To return to the subject of foundations, I would not venture to say which construction will give the best results, owing in a measure to the variations of conditions, particularly the foundations of the earth where the machine is to be located.

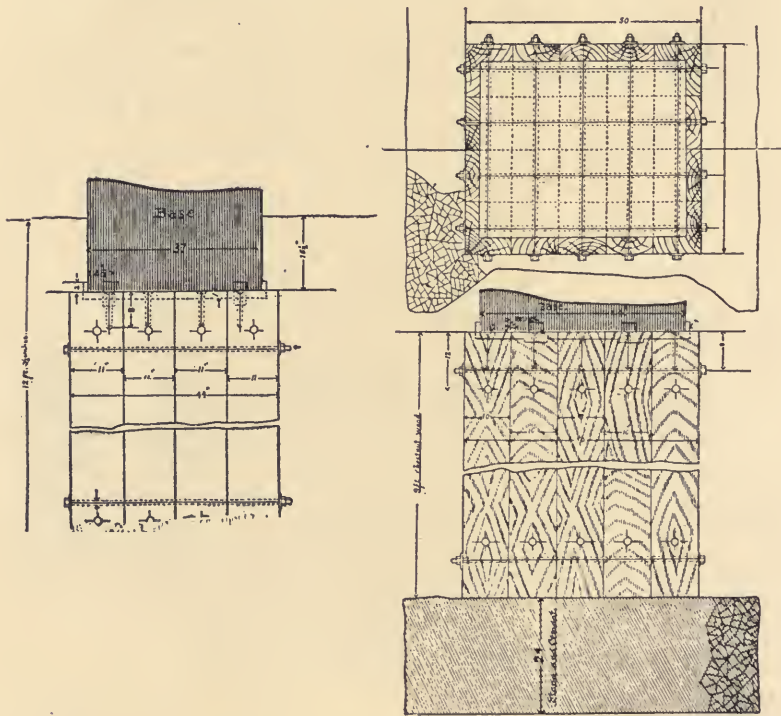

FIG. 175.—Drop-hammer foundations.

In fairly hard ground, such as clay, or where "hard pan" can be reached within fifteen feet of the surface, the following construction will give satisfaction: At the bottom of the excavation put in two or three feet of broken stone and Portland cement; on top of this place chestnut timbers on end. These timbers to be sawed on four sides and bolted together, the section of the block to be of sufficient size to accommodate the

base of the machine, and to have about 4 inches margin. It is preferable to have the upper end of the timbers several inches below the surface of the ground, as there will then be less liability to decay.

With a base of right proportion and a properly constructed foundation, the old method of fastening down the base by an-

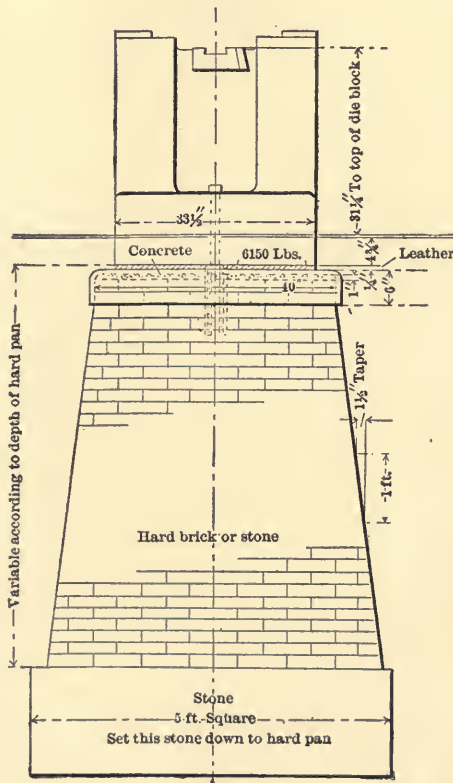

FIG. 176.—Drop-hammer foundations.

chor bolts is unnecessary. Angle irons at the corners of the base, fastened down to the foundation with lag screws, will answer the purpose.

Foundations for Drop-Hammers

One of the perplexing problems of the mechanical engineer is this very securing of satisfactory foundations for large ham-

mers, whether steam-hammers or drop-hammers. Numerous experiments have been tried with both elastic or yielding foundations and with those in which every precaution has been taken to make them as solid as possible. The builders of the drop-hammers quite naturally have experimented and accumulated experience of their own in this line, and must be assumed to know most of what is attainable on the subject.

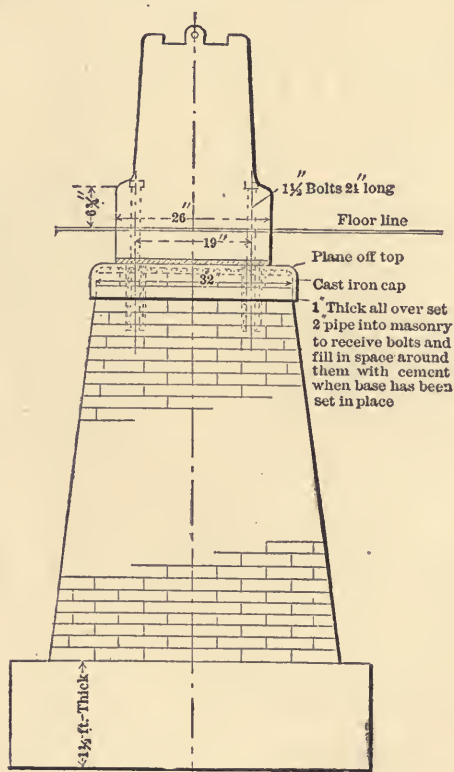

FIG. 177.—Drop-hammer foundations.

I present herewith (Figs. 176, 177) a standard drawing of a drop-hammer foundation of the Pratt & Whitney Company. They say: "We do not advocate much woodwork under these hammers, but would advise building a foundation of concrete or square block of stone or cast iron, bedded down to hard

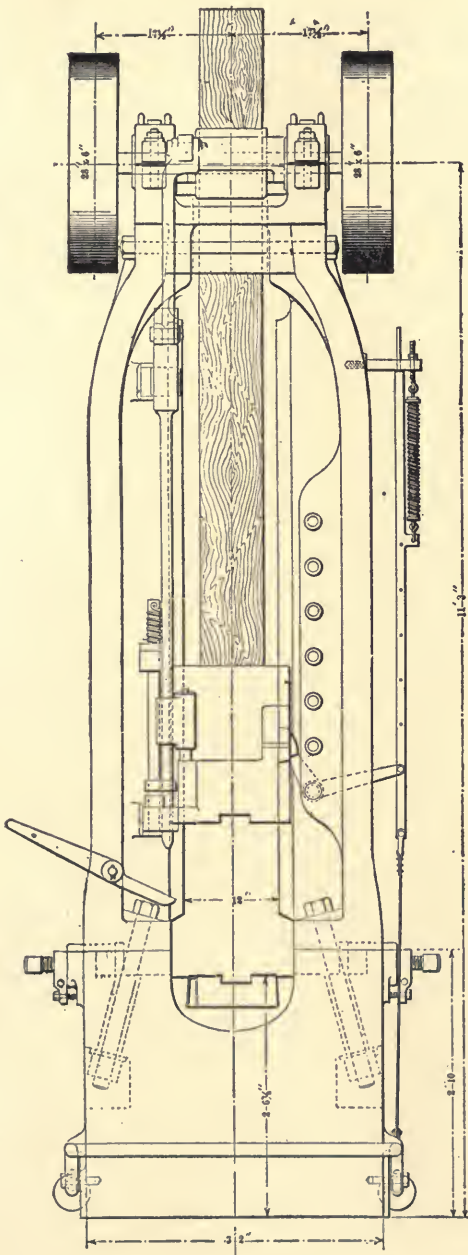

FIG. 178.—Front view of Ambler drop-hammer.

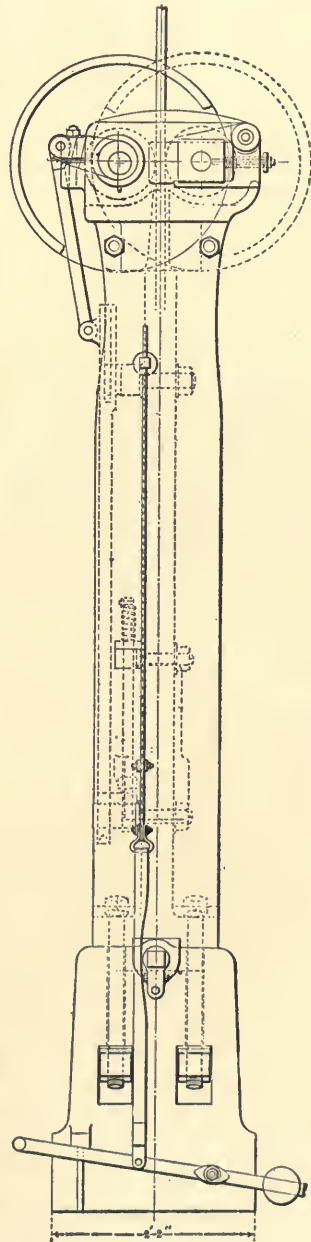

FIG. 179.—Side view of Ambler drop-hammer.

bottom. This is quite a departure from the usual way of setting a hammer, but it has been found to be much better, more effective, and less liable to breakage than with a wood foundation. All the cushion necessary with this foundation is but one layer of leather under the bed-piece. Too much attention cannot be paid to the foundations of drop-hammers. In all cases excavate to hard bottom, or, better still, to rock. This information therefore seems to be of little use where neither hard bottom nor rock is to be found.

The drawing shows a foundation built up of hard brick. Of course large stone-masonry is much better, but a cast-iron box, set into the ground and filled with Portland cement, is best. Solid stone-masonry is used by the Gorham Silver Plate Company, Providence, R. I. They have drop-hammers of 3,000 pounds weight of ram working on these foundations.

Drop-Hammer Effects

The Miner & Peck Manufacturing Company, of New Haven, Conn., have determined the relative effects produced by hammers of drops falling from different heights. They show the economy of using heavier hammers with short lifts. This is illustrated in the following way: "If you are operating a hammer of, say, 100 pounds,

at the same height you will obtain a result four times as great with an expenditure of four times the horse-power; while if you raise your 100-pound hammer four times as high you

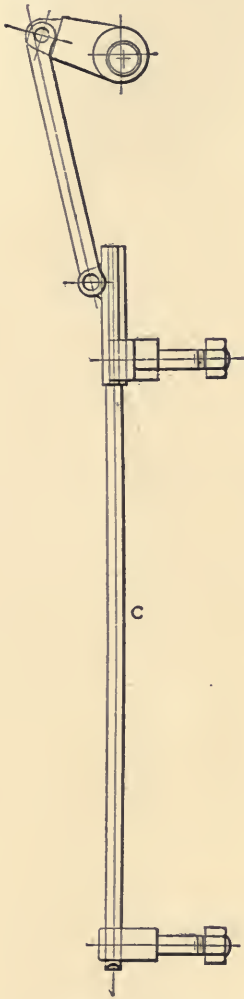
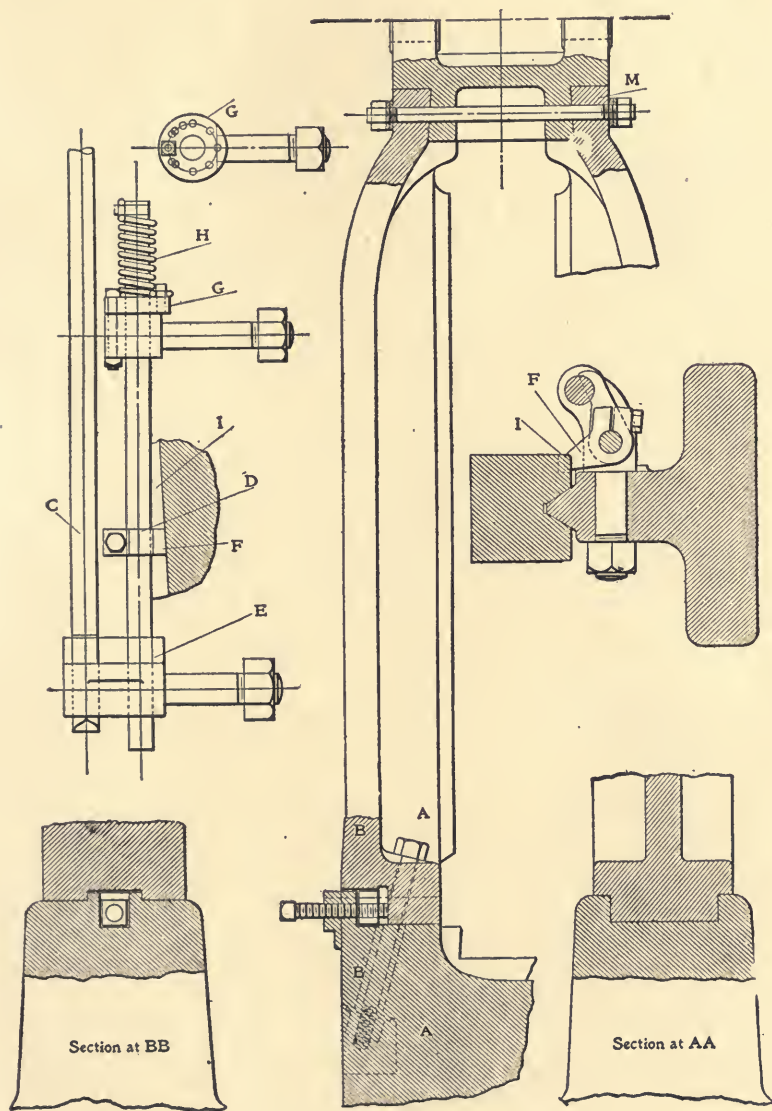

FIG. 180.—The drop-rod.



FIGS. 181 and 182.—Details of construction.

will expend four times the horse-power in doing so." The table shows the time consumed, the velocity, and the dynamic effect (expressed in pounds of static pressure) produced by a solid body weighing one pound falling freely from rest by the force of gravity.

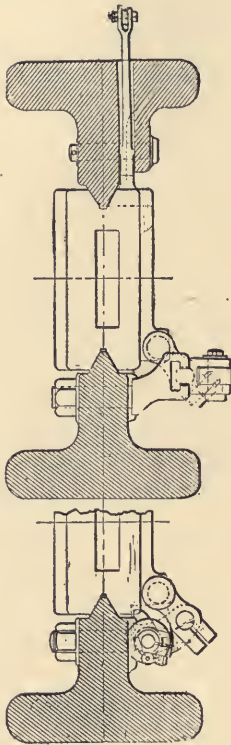

FIG. 183. — Construction details.

The Ambler Drop-Hammer

The endurance of drop-hammer dies and the quality of the work turned out by them depend very much of course upon the hammer with which the work is done. We illustrate here-with a hammer designed by A. A. Ambler, who for many years made a specialty of drop-hammer work in connection with various manufacturing concerns, and is now superintendent of the Foos Manufacturing Company, of Springfield, Ohio, builders of the hammer. The cuts show one of the hammers as used in the smith-shop of the company. The views in Figs. 178 and 179 are made from drawings. It will here be seen that the method of fastening the housings to the anvil-block is unusual, two bolts passing through each at an angle as shown, these tending not only to keep the

housings firmly seated within the recess in the block, but also firmly against the adjusting screws by means of which the guides are adjusted to proper position. It will be noticed that there are locks for these screws that prevent them being disturbed by the shock. This is shown more fully at Figs. 181 and 182. At the top the housings are attached to the crosspiece by through bolts, and are seated to what really constitutes a dovetail; locking all together very firmly, the surfaces are about 18 inches wide and the bolts have elastic

washers under the nut and heads. This is also shown in Figs. 181 and 182.

The drop-rod *C* (shown separately in Fig. 180) is jointed and operates the eccentric positively, as it is always kept vertical. *D* is the automatic trip-rod with a steel latch *E* keyed to it and tripping dog *F*, adjusting collar *G* and torsional spring *H*, by which it is seen that when the hammer-head drops the wedge-shaped portion *I* engages with the dog *F*, turning the trip-rod and latch sufficiently to release the drop-rod so it can fall. By means of the torsional spring *H* the trip-rod *D* is made very flexible and sensitive at the top, and by means of the vernier spacing of the holes in the adjusting

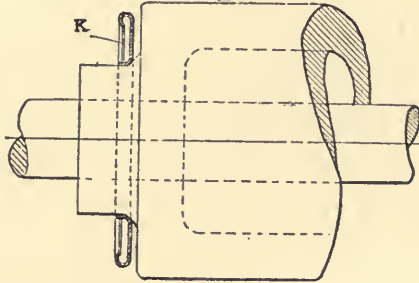

FIG. 184.—Construction details.

collar *G*, almost any flexure of the trip-rod *R* is obtained. The tripping dog *F* is adjustable vertically on the trip to be made at the most advantageous points, whether the dies in use are high or low.

There is also an improved cushion-bumper for the drop-rod which has proven by extensive tests to give a positive but easy action to the rod, entirely avoiding levers and similar complications. This construction requires no more attention in changing from a high to a low stroke than if the bumper were made of solid steel-block.

It is recognized that in all friction roll-hammers, perfect control of the action of the hammer can be obtained through the lifting board, only when it is entirely free from foreign

substances, especially oil. In recognition of this fact the hammer under consideration is provided with a special device for avoiding trouble from this source. The bearings all have chambers holding the oil in check until required for lubrication, and in case any of it should escape it is forced to the end of the roll and, by the centrifugal force to the cavity packed with wool or other absorbent material and there retained, thus preventing it from ever reaching the working surface of the roll or getting on to the board. A portion of the trouble with the hammer-boards is found to result from the fact that they are subjected to an excess of heat upon one

side, this heat coming from the furnace. In this hammer the board is so keyed into the hammer proper that it can be reversed, side by side and end for end, thus equalizing all conditions and wear.

These hammers are all designed upon a general ratio of 15 to 1 with reference to the weight of anvil and

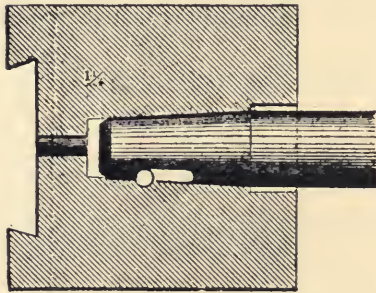

FIG. 185.—Method of securing hammer-heads.

hammer-head. In service the requirements demanded of these hammers have been especially severe and exacting. For instance, in the Springfield works of the International Harvester Company, where hammers are used placed within an inch of the natural bed-rock, they have retained their adjustments satisfactorily.

Securing Hammer-Heads

Fig. 185 illustrates a method for securing hammer-heads to piston-rods. A small space left below the bottom of the rod allows the taper portion ($\frac{3}{4}$ inch to 1 foot length of taper equal to twice the diameter of rod) to drive into the ram good and solid. The pin is for the purpose of raising the ram during the first stroke or two of the hammer. When the piston-

rod is first placed into the ram, the pin is made to rest against the lower end of the notch planed in the rod, giving the pin about one inch play above it, for driving the rod. There is also a space in the ram around the straight part of the body, as it is thought to be a difficult matter to obtain a perfect fit around the straight, and also the tapered part of the rod. I have known hammer-heads fitted up in this style (taper position a good ground fit) where it was necessary to bore the rod out of the ram after it had snapped off. This tight fit was caused simply by driving the rod into the ram, working the hammer under ordinary conditions; no shrinking of ram to rod or anything of that kind being necessary. In one case where the piston had been fitted into the ram, as here shown,

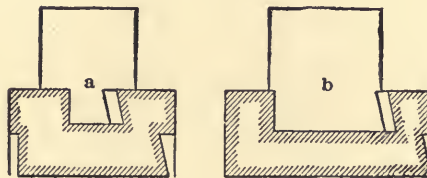

FIG. 186.—Fastening hammer-dies.

the ram was heated to expand, which generally answers the purpose of loosening the rod, but was “no go.” I have heard some suggest that there was danger of splitting the ram with this arrangement, but I never knew this to be the case, and have seen many hammers built. However, care should be taken to set the anvil $1\frac{1}{2}$ inches or 2 inches higher than the working level, to allow for the natural settling of the foundation, and also for the probable $\frac{1}{2}$ inch drive of the piston into the rod.

Hammer-Dies

The following pertains to file-forging dies. There were fifteen hammers, mostly Bradley cushion, but a few of them were plain trip-hammers. They had a lot of trouble with the dies from the shanks breaking off, as at *a*, Figs. 186, 187. I suggested for an experiment to make them as at *b*, which gave



FIG. 187.—Drop-hammer for heavy work.

good satisfaction and service, besides saving a lot of time and work in making the dies.

As our work was steel, we used on the larger sizes of work a small blast to blow the scale off the dies, instead of using water. On the small sizes we did not use anything, as generally the scale did not give much trouble. These dies were made of blocks that we got about the right sizes from the steel-makers. There were about twenty different sizes. The dies had to be dressed over about once a month, and making new ones and keeping the old ones in repair was about as much as one man wanted to do.

Improved and Up-to-Date Drop-Hammer

Modern manufacturing demands heavier work in all departments, and the forging-plant has in many cases outgrown the lighter hammer of a few years ago. To meet new conditions, and as a result of experience in its own plant, the Billings & Spencer Company, of Hartford, Conn., now build a new drop-hammer known as model C, and shown in Fig. 187.

An improved board-clamp catch-up is employed, which does away with the latch and connection at the side for holding up the ram. The board clamp is of an entirely new design, and is located at the extreme top of the machine above the friction-rolls or lifting device. This makes it impossible for oil to get between the clamps and board, which has heretofore been the cause of much inconvenience where the board-clamps have been used. Positive action is assured in the clamps by the operation of cams or eccentrics controlled by a foot lever attached to the base of the machine.

Another feature is a novel adjustment of the rear friction-roll by means of an eccentric, a duplicate of that used in engaging the front friction-roll, the two rolls, with their eccentrics being interchangeable. By this means of adjustment a true alignment between the lifting-board and rolls is always preserved.

A new form of bronze bushing is introduced on the eccentric bearings, which is easily and quickly removed and replaced. The same eccentric adjustment is also employed on the rear board-clamp. These adjustments of the rear friction roll and rear board-clamp are made by means of bars attached to the eccentrics and running down parallel to the upright to within easy reach of the operator on the floor. An improved method is also employed in attaching the head to the upright.

The uprights used on the new model are especially designed to reduce the liability of breakage, the distribution of metal being such as to afford the maximum strength. The cross-section of the uprights is that of a letter V, the apex forming the guide for the ram with a longitudinal rib running its entire length to add strength. An important feature in the construction of this machine lies in the fact that the uprights remain solid throughout their lengths, no weakening perforations being necessary in the placing of attachments. An improved adjustment for the uprights is employed at the junction of the base and uprights.

The releasing lever attached to the outside of the left-hand upright has an improved adjustment. This adjustment is in the form of a modified rack, intervals of $1\frac{1}{2}$ inches allowing the ram to be released at any desired height.

Capacity of Steam-Hammers and Size of Work

For making an occasional forging of a given size, a smaller hammer may be used than if we were manufacturing this same piece in large quantities. If we have a six-inch piece to forge, such as a pinion or a short shaft, a hammer of about 1,100 pounds capacity would answer very nicely. But should the general work be as large as this, it would be very much better to use a 1,500-pound hammer. If, on the other hand, we wish to forge six-inch axles economically, it would be necessary to use a 7,000 or 8,000 pound hammer. The following table will be found convenient for reference for the

proper size of hammer to be used on different classes of general blacksmith-work, although it will be understood that it is necessary to modify these to suit conditions, as has already been indicated.

Diameter of Stock.	Size of Hammer.
3½ inches.....	250 to 350 pounds
4 inches.....	350 to 600 pounds
4½ inches.....	600 to 800 pounds
5 inches.....	800 to 1,000 pounds
6 inches.....	1,100 to 1,500 pounds

Steam-hammers are usually operated at pressures varying from 75 to 100 pounds of steam per square inch, and may also be operated by compressed air at about the same pressures. It is cheaper, however, in the case of compressed air, to use pressures from 60 to 80 pounds instead of going higher.

In figuring on the boiler capacity for steam-hammers, there are several things to be considered, and it depends upon the number of hammers in use and the service required. It will vary from one boiler horse-power for each 100 pounds of falling weight up to three horse-power for the same weight, according to the service expected. In a shop where a number of steam-hammers are being used, it is usually safe to count on the lower boiler capacity given, as it is practically safe to say that all of the hammers are never in use at the same time. In a shop with a single hammer, on the other hand, and especially where hard service is expected, it is necessary to allow the larger boiler capacity, as there is no reserve to be drawn on, due to part of the hammers being idle, as in the other case.

Steam-hammers are always rated by the weight of the ram, and the attached parts, which include the piston and rod, nothing being added on account of the steam-pressure behind the piston. This makes it a little difficult to compare them with plain drop or tilting hammers, which are also rated in the same way.

Rules for Finding the Capacity of Steam-Hammers, and the Horse-Power Required for Operation

I call attention to some simple rules regarding steam-hammer practise, which may be of value to some of my readers. The first of these rules gives the horse-power required to run a hammer of any size, and may be expressed as follows: *Divide the rated capacity of the hammer, in pounds, by 100, and the quotient will be the horse-power required to run the hammer constantly.*

This rule is also applicable in cases where the hammer is not run constantly, by estimating the amount of time the hammer is idle each hour and making allowance therefor. But it will be noted that in case the hammer is not run constantly, or nearly so, and the horse-power is correspondingly reduced, sufficient steam-storage space must be provided in the boiler to prevent the steam-pressure being drawn down much faster than it is made during the working period.

The second rule deals with the estimate of the proper size of hammer to be used in working iron and steel of any desired cross-sectional area. The rule is as follows:

Multiply the greatest cross-section desired to be worked in the hammer by 80, if of steel, or, 60, if of iron, and the product will be the rated value of the hammer required in pounds.

This rule will give a hammer for safely working material of the size specified, at one heat. No doubt many of my readers are doing what we frequently do, that is, work billets which exceed in size that which would be allowable if the rule was always followed.

Development of Steam Drop-Hammers

Without raising the question of who was the pioneer in steam drop-hammers, Mr. F. B. Miles, who later became a member of the firm of Bement, Miles & Co., designed in 1872 what seems to be the first steam drop-hammer made by his company, and which was sold to the Baldwin Locomotive

Works. Since that time this class of machinery has grown to be a large factor in the product of Bement, Miles & Co., now the Niles-Bement-Pond Company.

Since the first hammers were made by Mr. Miles, there has been little change in the important points of construction, such modifications as have been made being simply augmentation, with the vital or working parts as he conceived them. As a proof of the good design Mr. Miles produced, I have to point out that most, if not all, steam-hammers manufactured in this country to-day are constructed on the same lines, and the illustrations of them point very strongly to direct copies of what has become known throughout the trade as "Bement hammers," which shows a growth of the same mechanism produced over thirty years ago by practically the same company, and with no radical differences in principles.

CHAPTER VI

STEEL AND IRON: TWISTING, REDUCING, AND FORGING.—
TREATMENT FOR WORKING IN MACHINE FORGING

Action of Steel and Iron Under Different Degrees of Heat

A FEW years ago some ornamental forgings were being made by students in the blacksmith-shop of the Alabama Polytechnic Institute. The designs included some pieces of $\frac{1}{2}$ inch square, which were to be twisted, and the students were having difficulty in getting a uniform pitch to the twist. The iron would be heated for several inches, clamped in a vise, and twisted with a pair of tongs. As would naturally occur, the piece of iron was clamped in the vise and clasped by the tongs near the ends of the hot part where the heat merged from red to black. In almost every case when the twist would be made it would appear greater at the ends near the vise and tongs.

The first conclusion was that the fastenings must exert some influence to produce the effect. A piece was tried with the fastenings attached directly to the bright parts. In this case the twist came out very uniform. A long piece was then heated in the middle and clamped at the ends where the irons were cold. On making the twist the same effect was observed as at first, the greater twist occurring in the dark-red heat.

Samples of $\frac{1}{2}$ -inch round iron were then tried to see if the form of cross-section had any influence. So far as could be observed, the effect was the same as the square iron. The forge in which the specimens were heated was thoroughly cleaned and samples of $\frac{1}{2}$ -inch round iron were then tried to see if the form of cross-section had any influence. So far as could be observed, the effect was the same as the square iron. The forge in which the specimens were heated was thoroughly

cleaned and a fresh fire built with the good, clean blacksmith coal, samples of which were analyzed in the Chemical Laboratory and shown to be very low in sulfur and phosphorus. The results were the same as before.

Finally, two students—Messrs. J. S. Black and M. F. Kahm—took up the investigation as a subject for this work, spending a good deal of time and obtaining the following results. The work, while not exhaustive, covered a good deal of ground and was carefully done. The results are interesting if they establish, as the writer believes they do, that wrought iron is stronger when at a white heat than when at a red heat.

Careful search was made through the literature available, but only one reference was found alluding to similar observations. This was in the *American Machinist* of November 11, 1897, in an article by Mr. B. F. Spaulding. He says: "There is a peculiarity about some iron which I have often observed with curiosity, but which I do not remember to have seen mentioned. If a bar of this iron is heated for some distance in the length of it to a uniform white heat, it appears to be stiffer in that portion than it is at the lower temperature, the red-hot part, which intervenes between the cold ends and the white hot part.

"This peculiarity of being less readily bent where it is the hottest is shown when an attempt is made to bend it by letting the middle rest against something, as, for instance, the horn of the anvil, while each end is pressed in a direction to bend the bar. The bar will then have a greater bend at the places where it is red than along the part where it is white."

Materials Used in Experiments

The inference from reading this article is that Mr. Spaulding only attributed this property to certain kinds of iron, or to iron under certain conditions, but the experiments seemed to show that all wrought irons are similarly affected. The material for these experiments consisted of the following stock, all $\frac{1}{2}$ inch square and ordered from a jobbing house: Jessop tool

steel, a medium grade of American tool-steel, machinery steel, Norway iron, charcoal iron, and common or stone-coal iron.

The forge for heating the specimens was fixed with fire-brick to limit the length of the heat on each specimen and also to insure a uniform length for all. Special care was taken to keep the fire clean and in good condition. A good grade of blacksmith-coal was used. The apparatus for twisting consisted of a lathe fitted with a vise and an extra spindle with a large socket in one end and a crank fitted on the other. After the specimen had been heated, one end was put in the socket

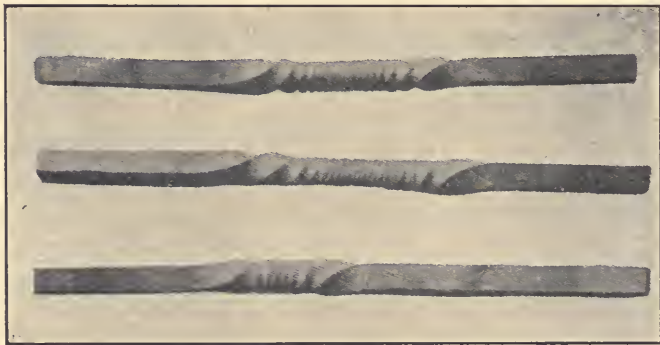

FIG. 188.—Samples of Jessop steel.

and the other end fastened in the vise in line with the spindle. A few turns on the crank would do the work.

A small testing machine was used for making the tension tests. After a little practise the boys were able to put the specimen in the clamps and pull it out to breaking before any marked change of the color due to cooling could be observed. No effort was made to measure the pull exerted by the machine.

For the bending tests, a sliding-block, operated by a lever, was made to press on one end, the other end being supported by a fixed block. The specimens for this test had the ends made hemispherical.

In another test a small hammer-head was fitted with a punch ground to an angle of 60 degrees and attached to a long

handle pivoted at the end. Arrangements were made to fix the distance through which the hammer was allowed to drop. The specimen was heated, as in the other tests; laid on the anvil under the punch, and the latter raised and dropped rapidly as the specimen was moved along, making the marks about half an inch apart.

The specimens were cut from the bar and were made of convenient length for the different tests. For the twisting tests they were about 12 inches long and three pieces of each kind of metal were tried. The illustrations show the results very clearly (Figs. 188 to 195). The high carbon steel shows

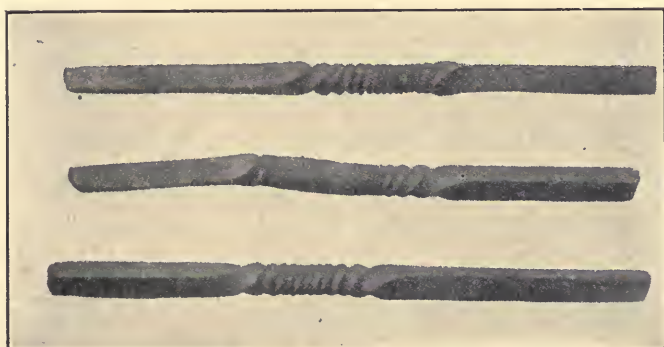

FIG. 189.—Samples of ordinary American tool-steel.

the greatest twist at the point of highest temperature. The machinery-steel gave indefinite results. One specimen seemed weaker in the hottest part, another twist most at the red heat, and the third seemed to have two or three weak points.

The specimens of wrought iron gave unmistakable evidence of being weaker at the red heat, and the purer the iron the more marked the effect. The Norway iron seemed to twist all at one place in the dark-red heat, the part at the white heat showing very little twist. The charcoal and common irons showed less difference in strength between the two temperatures, though the differences are still very evident.

The tension specimens show similar but, if possible, more

uniform results. The high carbon steels show the reduced cross-section at the point of the highest temperature, while the machinery, tool, and the different grades of iron have the points of reduced cross-section, one on each side of the white-hot part. A number of these specimens pulled apart with very much less reduction of area than the material would have shown if tested in the ordinary way and at the usual temperature.

The bending tests were very inconclusive. Sometimes the bend would occur at the white-hot part and sometimes in one of the red parts, but never in a way to give definite information, either to corroborate or contradict that obtained from the

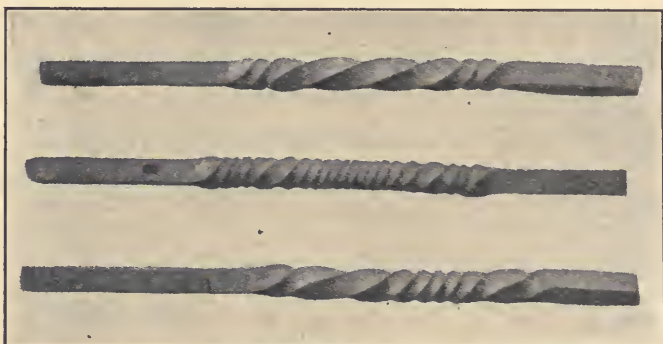

FIG. 190.—Samples of machinery steel.

preceding tests. The specimens shown in the illustration were bent with tongs over the horn of an anvil in the manner suggested by Mr. Spaulding in the article previously referred to. The punching tests could be seen by the eye to corroborate the twisting and tension-tests, but the marks were too small to show in photograph, and were unsatisfactory to measure for tabulation.

Fuel Used in Tests

A careful analysis of the coal used in these tests showed less than one-half of one per cent. of sulfur. Care was taken to keep the fire clean and a sufficient thickness of bed was carried to insure that the metal would not be struck by cur-

rents of cool air. The bars were heated just to the point of sparking in the middle, and the total length of the heated part was about 6 inches. While the specimens shown in the illustrations were all made in one series of tests, yet these results have been duplicated many times before and since these tests were made, taking iron from different lots and coal from other places. If these results are due to impurities in the fuel, it would seem that the tool-steel would be more affected than the iron, as it is considered more susceptible to injury from such causes. But one of the Jessop steel specimens was twisted more than twenty revolutions without breaking, show-

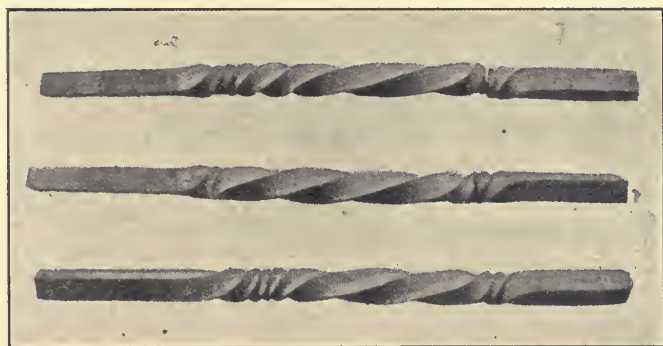

FIG. 191.—Samples of good charcoal iron.

ing it was in a pretty fair condition. Then we used the same fuel for tempering taps, dies, reamers, and milling-cutters, and they stand up to the work as well as any we can buy.

If this peculiar effect is due to some molecular action in the metal, it would be interesting to know what this action is and what causes it. It seems from the foregoing tests that a small amount of carbon will reduce the effect and that a larger amount will entirely eliminate it and cause the molecules at the highest temperature to be most easily moved. The writer has desired to pursue the investigation of this subject further, but time has not permitted him to do so. The illustrations show the results of the experiments in these.

Practical Results of Experiments

Fig. 188 represents three samples of Jessop steel. The middle one was twisted more than twenty revolutions and did not break.

Fig. 189 represents ordinary American tool-steel.

Fig. 190 represents samples of machinery steel. One seemed to twist most in the hottest part, one most in the coolest parts, and the third or middle specimen twisted very irregularly.

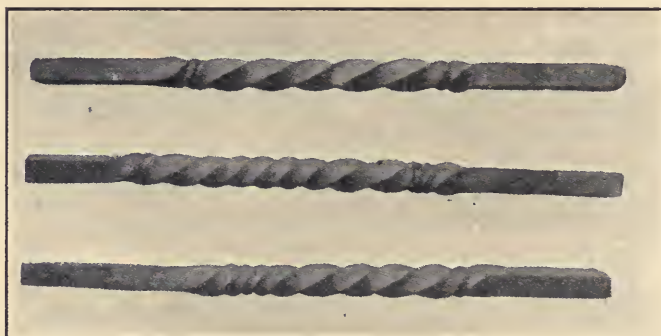

FIG. 192.—Samples of stone-coal iron.

Fig. 191 represents samples of a good grade of charcoal iron. It will be noted that two of these broke off at the dark-red part of the heat.

Fig. 192 represents specimens of common or stone-coal iron. Two of these are fractured, but not entirely broken off in the dark-red part of the heat.

Fig. 193 represents specimens of Norway iron. These were the first specimens tried, and there was a slight irregularity in the length of the heated part. Also one of the specimens cooled down to a red heat before being twisted, and it shows a very uniform pitch.

Fig. 194 represents the results of the tension-tests. Beginning at the left there is Jessop steel, American tool-steel, machinery steel, charcoal iron, and Norway iron. The

machinery steel in all the tension-tests showed the same characteristic as the wrought iron.

Fig. 195 represents two samples of wrought iron and one of the machinery steel. These were bent over the horn of an anvil with tongs. The machinery steel in this case fails to show the characteristics referred to under Fig. 194.

Working Stock in Drop-Dies

A considerable part of the expense incurred in the production of drop-forgings is the cost of the dies in which the work is shaped. The proportion which this expense bears to

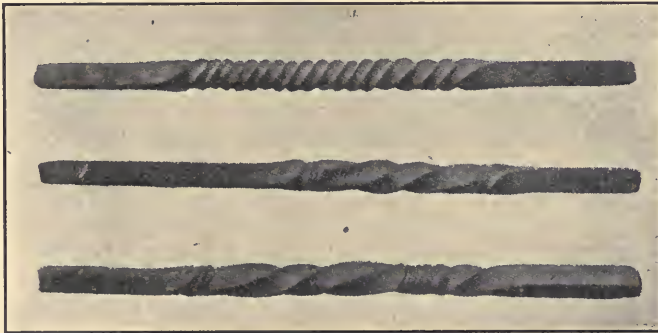

FIG. 193.—Samples of Norway iron.

the cost of a certain number of forgings depends upon the durability of the dies. When the making of the forgings is a permanent business and they are in constant demand in such numbers as to require the renewal of the dies from time to time the proportionate cost of maintenance of the dies in good condition is sometimes insignificant and sometimes important.

There are circumstances under which the cost of dies must be noticed. It is often expedient to make drop-forgings in order to obtain the advantage of the uniformity which the dies give them, although the number of forgings required may be so small that the dies need not be much worn when the entire amount of forgings has been made, but in this instance, as in every other, it is for obvious reasons very desirable to have

the dies retain their original perfections so far as possible. In such cases the cost of the dies is a large factor in the cost of the work. It is best to keep them, for there is always a possibility that they may be needed again.

Facilities for Reproduction of Drop-Dies

When it becomes evident that a large number of pieces have to be made, and that the tools for making them will require

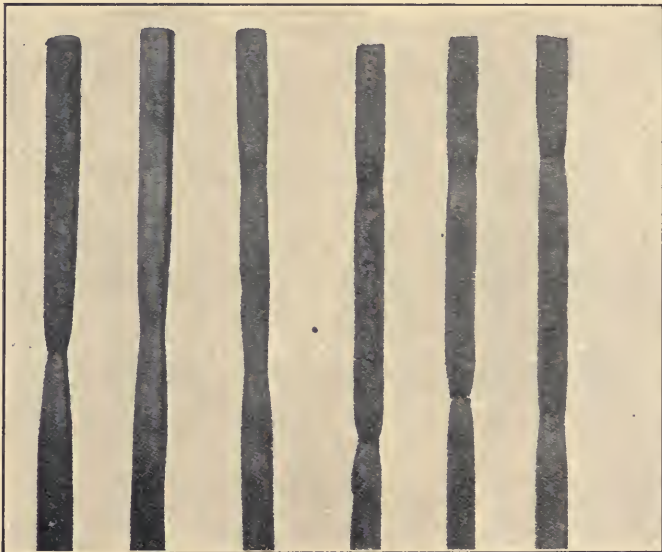

FIG. 194.—Results of tension tests.

frequent renewal, it becomes a matter of economy to provide reasonable facilities for the reproduction of these tools, and also to fix the methods which should be adapted for the use of the tools so as to insure their utmost effectiveness and durability, and restrict within the narrowest limits the expenses of profitless manufacture. On drop-work, for instance, it is to be determined what sized drop shall be used, and how many blows shall be struck at each operation. Drop-dies therefore come well within the scope of the rule. They are quite expensive in both material and workmanship, and are often sub-

jected to the handling of piece workmen who are naturally a good deal more interested in getting all they can out of them, in the shortest possible time, than they are in their preservation.

It is true that drop-hammer men soon become shrewd enough, as a general thing, to know that the better care they take of their dies, the easier and more freely they will work, but as they stand with a piece of work in the die, which is not

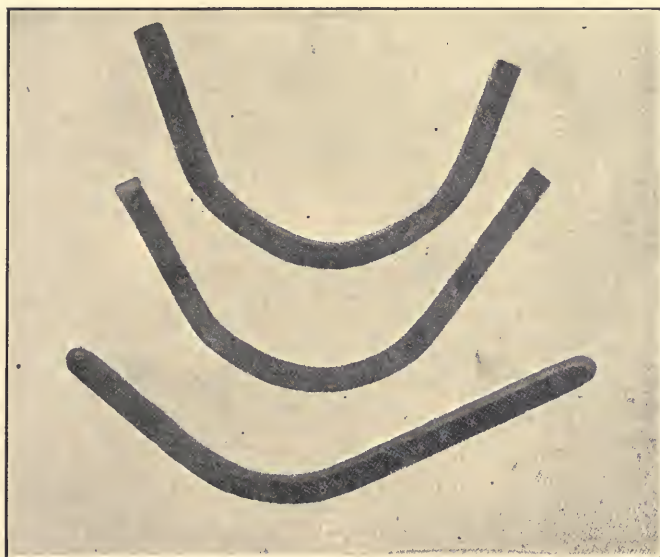

FIG. 195.—Samples of wrought iron and machinery steel.

quite filled out with the blows already struck upon it, there is but an instant afforded them in which to decide whether it is best to give the cooling-piece one blow more without reheating, and in that critical moment they are liable to be overcome by a surge of self-interest, and decide to hit it again and risk the die.

Spoiling Dies

A hot piece of iron might lie loosely in the impression of a die until it is cooled. It could become cold without heating the corners around the impression enough to seriously affect

their temper; but it is quite a different thing when the hot iron has already been struck with such force as to bring it into more intimate contact with the steel of the die than its own grains have with each other, for the steel has the heat absolutely forced into it when an additional blow is given. If this will not draw the temper, nothing will, and if the corner of the impression is already almost red-hot, then the additional blow, driving down on almost cold fin, will drive down the corner, and make it overhang and hug the work so that it will be hard to disengage if from the die. Then the good hammer-man, if he is not unmindful of the future, will have the die fixed before it gets any worse; but if his temper rises with that of the die until his work sticks so bad that, in removing it, it gets out of shape so much as to damage it, then he will have the die repaired.

A drop man says it is more exasperating to have the work stick in the upper die than in the lower one, especially if the drop is working on a high stroke. His work is pulled off his grasp in spite of his most energetic efforts to retain it. He relates that he was amused a short time ago to hear a fellow, who was thus bothered, vent his feelings by exclaiming to his bewitched work as it went upward, "Oh, you're going to be an angel, ain't ye?" Sticking in the upper die is so troublesome that it is generally relieved as soon as possible.

The Dies and the Drop

As a general rule it is better for the dies to have the blow of the drop struck on the hot material with force enough to fill them at the first stroke without allowing it to remain in them for a repetition of the blow. This would often require a heavier drop-hammer than is available. There are some objections in using heavy drops, among which the very palpable one of first cost is generally effectual.

There is another which demands consideration, and that is the effect which the sudden application of power to raise a heavy weight has upon the shafting and carries back in some measure toward the prime motor, diffusing itself and being

absorbed, partly, among the revolving pulleys and shafts and running belts until its last vibration is taken up by the fly-wheel.

There are some other objections also, and it therefore becomes a question whether it is better, when all things are taken into consideration, to drop heavy enough to make the piece at one blow, or strike it two or more.

In this consideration the fact must not be neglected that whether a heavy drop is lifted one foot to strike a light blow, or five feet to strike a heavy blow, the application of power, required to give it its first impulse upward, is as great in one case as in the other, and therefore the effect of shock upon the motive power and its appliances is less when light blows are struck with light drops than when light blows are struck with heavy drops.

Economy of Dies

Leaving out of the question, however, everything but the especial economy of the dies, it is better to finish at one blow all the work the dies have to perform at each insertion of the hot piece. The dies will last longer when thus treated, and the corners of the impressions will retain their original form longer than when the pieces are submitted to more blows before removing them from the dies.

The effect upon the work of striking one blow or more is a different question from that relating to the effect upon the dies, and to this question it must be replied that in a majority of instances the stock is better by being struck more than one blow. Action and reaction are equal, however much the attacked may retire before the advance. The falling die delivers its force, and the stock is driven into every recess open to it, but there is reaction enough to stop the blow, and resiliency still in the struck mass, even if it has been strained beyond the bounds of complete recovery, and instantly before the weight is lifted—the particles have recovered to some extent their lost positions, or have moved back toward them and this repulsion leaves them with an

open grain, and it is only by striking them, blow after blow, that the particles can be pressed into a close union which they will retain, each blow leaving them nearer until the stock is got into that condition when the force of the blow no longer strains them beyond the limit of elastic recovery.

Practical Effect of Working Iron

This is the practical effect of "working" iron, and its benefits are more or less displayed on drop-forging in proportion to the number of blows which are affected up to the point of full efficiency. A greater blow than one that is efficient produces no more useful effect than one which is simply sufficient. A number of disturbances, from which the forgings recover in different degrees, is necessary to produce close texture and the greatest amount of cohesion; in short, the best material.

Effect of Drops on Stock

Practically little regard is paid, as things go in shops where drops are used, to the effect which the working of the drops has upon the stock. In the olden time, when the blacksmith's soul was in his work, the art of working upon the anvil was not gaged by the amount of work thrown upon the floor, but somewhat, also, by the qualities which the manner in working the material conferred upon it. This is little considered now, for the reason that, as it is ordinarily worked, the material is abundantly good for all purposes for which it is used. If upon trial one brand of stock is found to be defective when worked in a certain manner, the working practise is not changed, but another brand of stock is secured which will yield good results when worked in the manner adopted.

Working in Drop and Bending-Machine

The increasing employment of bending-machines has extended and rendered more imperative the necessity of securing stock which will stand the peculiar usage to which it is

subjected in forming. A blacksmith can humor the peculiarities of any kind of iron or steel by his manner of working it upon the anvil, but a man who runs a machine which makes 600 or 900 strokes an hour, and is called upon to bend a piece of iron into a certain form at every stroke, has not time to fool away in humoring the proclivities of any die-stock. He may favor it within reasonable limits by his manner of heating it, but when it is submitted to the action of the machine, the quality of mercy is strained to the breaking-point, and the stock must be of such a nature that it will take, without serious injury, the impression of the dies. One of the conspicuous results of these conditions is, frequently, the substitution of soft steel for pieces which might otherwise be made of iron.

There is a distinction between the classes of work which are usually done under the drop, or in the bending-machine. In the drop-dies, the particles of stock are generally pressed together very closely, while the operation of the bending tends to strain apart those on the outside of the bend. Most any kind of stock can be jammed into a hole in a drop-die, but the bar bent on a bending-machine must have some degree of tenacity, to bend without cracking.

Even cold shuts will close so completely in a drop-die that they are undiscoverable until the piece is put to some stress which will disclose them. Due caution must therefore be exercised in devising drop processes, to adopt such as will insure sound forging. Too much reliance must not be placed upon fair outsides.

Whenever it becomes necessary to place dependence upon uniting stock by welding in drop-dies, it is the safest way to have the welding done at the first blow. The parts which are forced forward to be united at the second blow are liable to be dry, filmed over, and unwelded.

If the two, or more, blows are to be struck on a piece at the same heat, in the same dies, it is a great relief to the dies to at least loosen the piece in the dies the instant they separate. This proceeding breaks that intimate contact between the hot

piece and the die, which affords the bridge for the quick passage of the heat to the edges of the impression, which it softens and makes susceptible to injury. It does not require a wide separation to greatly weaken the conducting capacity of actual contact.

When it is found that the drop-forgings do not have the strength which they were calculated to possess, some revision should be made of the processes, and such corrections applied as may have a favorable effect. If the dies are properly devised and the work is carefully manipulated, the material in the drop-forging can be brought to the highest degree of excellence which such stock is capable of possessing. The stock can be wrought in the drop-dies to its greatest perfection without much injury to the dies. Stock allowed to cool from a welding heat, with no work done upon it below that heat, is very far from being in the best condition.

Improved Anvil Block

There is nothing which makes a forge-room so untidy in its appearance as anvils carelessly placed on the wooden blocks. Even those secured firmly to the blocks by means of straps of iron, bolts or staples, in time work loose, shift about, and frequently fail altogether. To hold the anvil firmly, to have it look neat, and at the same time to make it as noiseless as possible when in use, is a problem demanding much thought and experience.

As it is desired to use wrought-iron anvils in preference to cast-iron, several experiments have been made. The result is that two blocks are now in use in the forge-room: one is mounted with a Trenton and one with a Hey & Badden anvil, both being wrought-iron anvils. These are satisfactory in every respect, and the difficulty in holding the anvil secure is solved. All noise and vibration when the anvil is struck are stopped, and its general appearance is very neat. The anvil is made fast to a mass of concrete (Fig. 196) of broken stone and cement encased in a rectangular shaped box 18 inches high, made of cast iron $\frac{5}{8}$ inch thick, with a base 14

x 18 inches tapering up to 8 x 10 inches at the top, being 1 inch larger, inside measurement, than the base of the anvil. The anvil, as stated, rests upon the concrete 2 inches below the top of the casting. On each side (front and back) of the anvil, embedded in the concrete to the depth of about 3 inches, is a bolt and nut, the nut projecting up to nearly the top of the casting, and about 1 inch above the concrete. On the top of this concrete melted lead is poured (filling up this space

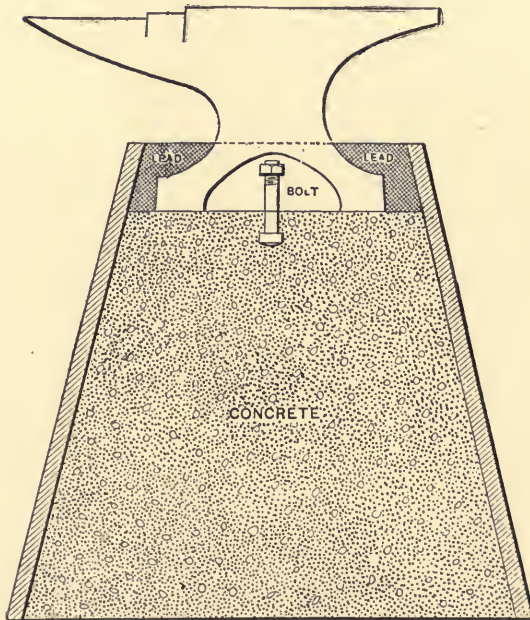

FIG. 196.—Improved anvil block.

between the base of the anvil and the top of the casting about 2 inches) which flows all round the anvil, the nut of the bolt, and into the corners of the casting. The taper of the casting, together with the nut, holds the lead to the cement, and this, it is evident, holds the anvil firmly.

Several methods have been thought of, such as having the anvil rest on a box of sand, mounted on wooden and concrete blocks by means of bands of iron, hook-bolts, staples, etc.

All these devices failed to give the result desired. It was found that by placing 1 inch or more of the base of the anvil in a tub of water, it lost its ringing sound, the vibrations ceased all together and the sound, when struck with a hammer, was dead, so to speak, as much as the so-called noiseless anvils made of cast iron. The base of the anvil rests on the concrete, and is gripped by the lead. This arrangement stopped completely, just as the water did, all vibrations. The cost of this method of mounting anvils should exceed but little the cost of the anvils mounted in the usual way on the wooden blocks with straps of iron, etc.

CHAPTER VII

PRESS AND HAMMER FORMING OF HEAVY HOT AND COLD BAR AND SHEET STOCK IN DIES, TOGETHER WITH MANUFACTURE AND ASSEMBLING OF FINISHED PRODUCTS FROM SUCH

Making a Wheelbarrow Wheel

WHEN a new piece is to be produced in quantities, and the job has been worked through carefully, and decisions have been made on all the operations, tools, and fixtures needful, then it is sometimes a good thing to forget that there are such tools as drillers, lathes, planers, millers, and screw-machines, and remember squeezing tools alone.

Some things cannot be made by pressing and punching, hot or cold; but really, when we look the field over carefully, it will be seen that almost everything can be made of sheet or bar stock, in some forms of rolls or presses.

For a big thing, a wooden freight-car doesn't look at first like a press job, and for a little thing a wooden wheelbarrow wheel doesn't seem exactly fit for production from metal, with not a cut made on it.

It is not so very long ago since the pressed-steel freight-car became an established production. Metal wheels have been made for many years, but plenty of wooden wheels are still used, because it takes a long, long time to change existing practise, even when the new thing is not only best and cheapest in the long run, but is the lowest in first cost and by far the most durable of the two.

The expert machine designer should not let habit and custom hinder him from seeing more than one way to produce what he wants, yet he often does take the handy and costly way, because it is the way he knows best, and because others have gone the same way for a similar output. It is easier to do what has been done, than to do the best that can be done, and,

if one follows the old way, he escapes the stigma of experiment, and stands on the safe ground of established practise and conservative engineering. "Conservative practise" is a fine term, fine to capitalists, and to routine followers, and when some rule-breaking experimenter finds new and better ways of doing things, then conservative practise becomes dear in the other sense of the word. Sad to say though, sometimes the experimenter does not come out right, and then

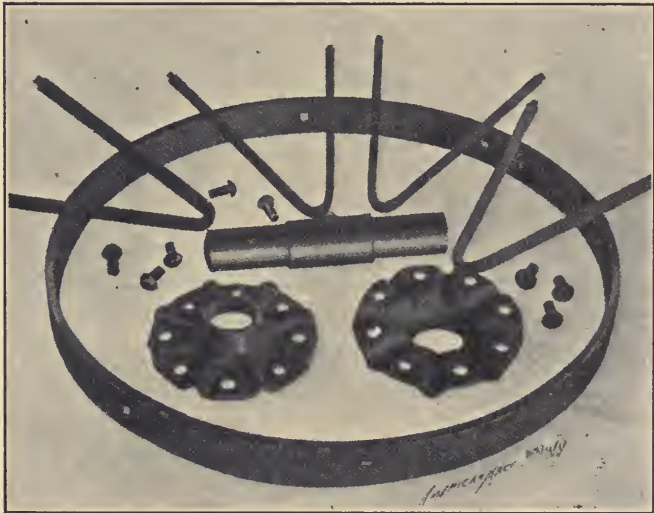

FIG. 197.—Parts of wheel ready for assembling.

the old-way advocates can be happy and say, "I told you so" with complacent joy.

Operations on Wheel

The parts of the eight-spoke metal wheelbarrow wheel are shown in Fig. 197, and consist of the cored cast-iron hub, two hot-pressed steel flanges, four bent spoke parts, two spokes each, eight rivets and the welded wheel rim.

The cast-iron hub calls for five or more operations—making the core, molding, pouring, tumbling, and spruing on the emery-wheel. The coring length and outside diameters

are all close to uniformity, and the hub and side flanges and spokes make a firmly united structure after they are assembled in the press, before riveting (as shown in Figs. 208 and 209), as the eyes of the hub-flanges are forced down hard on the outside of the hub.

For the tire, seven operations are required—to cut it off from the bar, straighten, punch with a hole for each spoke end, six or eight as may be, and two rivet-holes for the weld-

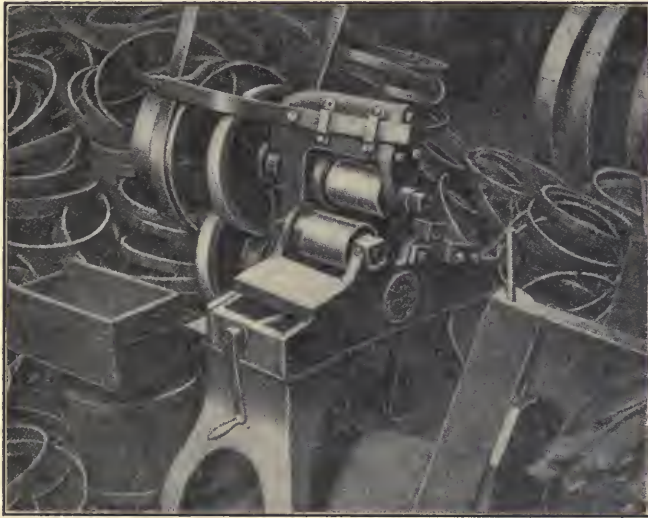

FIG. 198.—Small rim-bending rolls.

rivet, which insures the correct tire diameter; insert the weld-rivet, heat and weld, and finally form and trim on a round iron-block. None of the operations on the wheelbarrow tire are shown, as larger wheel tires were in work the day the pictures were taken.

The tires are cut off in the press, and all the holes are punched at once—square holes for the spoke ends, and a round end for the welding-rivet. Fig. 198 shows the little Moline tire-bender, three rolls open at the right hand, one adjustable. The larger tires are bent in a larger Moline machine, Fig. 199, having the adjustable roll carried on a

rectangular gibbed slide at the left. The company make wheels up to 54 inches diameter, with rims 6 inches wide, and fit them with two sets of *V*-section spokes, spread at the base, and extremely substantial in construction, to carry as much as 3,000 pounds load per wheel—an entirely different affair from this simple and cheap wheelbarrow wheel.

The rims are heated for welding in the natural-gas fire, shown in Fig. 200. This is a fire-brick pit, not very wide,

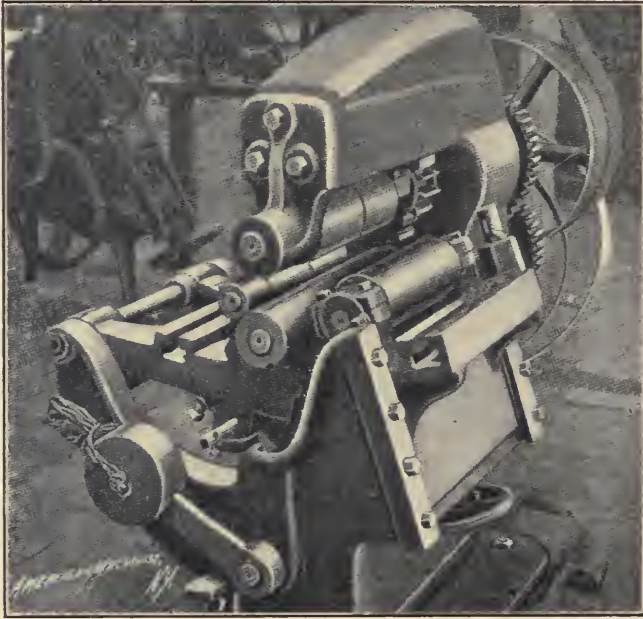

FIG. 199.—Larger rim-bending rolls.

having two loose fire-brick sliding covers, raised up on bricks 2 or 3 inches above the hearth surface. The natural-gas pipe is at the left, globe valve regulation, and the tin air-pipe takes the gas at the top bend, above the flat air-regulating slide, fixed in position with the thin wooden wedge lying on top of the slide. The flame was shut off for the camera exposure, but the pit was yet red hot. The two fire-brick covers are made each of two bricks, pierced together with clamp-plates

and bolts, all as clearly shown. When the tires are to be put in the top bricks are shoved along endwise, and shoved back again to cover the tops of the heating-ends, and the fire is extremely rapid in action.

The superintendent was very loath to permit a picture of this simple, cheap, convenient, and most effective hearth to go out, because it was not more elaborated. Like everything else in this shop, this fire was working all day every day all right,

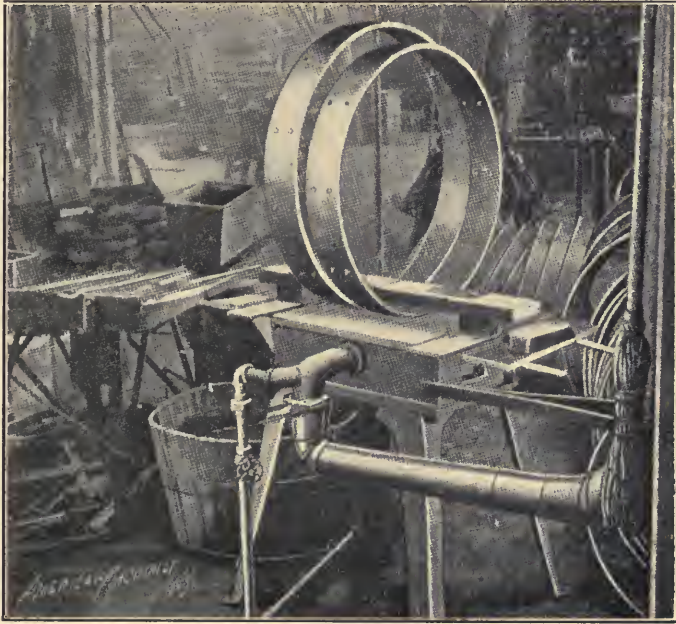

FIG. 200.—Natural gas fire for welding tire.

costing next to nothing in fuel, extremely good in every way, which did not at all hinder the superintendent from wishing it not to be shown. I, on the other hand, regarded the fire as a model construction, very difficult to cheapen or improve.

The rims are welded on horn-frame "Justice" spring-hammer, as shown in Fig. 201. The top spring and cranks are covered by a large sheet-metal case, as the hammer works fast. The hammer works only a few seconds on each weld, and the

tire is then taken by the helper, who trims the weld a very little with a hand-hammer, which completes the welding.

Welding makes the rim ready for the spokes. The spokes are made two in one piece, of oval steel rod, cut to length, and slabbed on the sides to form a square tenon on each end to fit the square hole punches in the tire, and then formed V-shaped in the press, as shown in Fig. 202. There are four operations on the spoke *V*, only one, that of bending, being illustrated. First the spoke-blank is cut to length, then



FIG. 201.—Welding wagon-wheel rims on Justice hammer.

slabbed on one end at a time for the square tenon, then formed by being laid on top of the V-horn of the press in the gages, which are of the same thickness, slotted so that the forming tool in the press-slide can bend both ends down into the completed form shown in Fig. 197.

The spokes are riveted into the tire by a rapid pneumatic riveter, the piston being crank-driven, and the tool being a reproduction of the flat hand-hammer peen, turning round a little between blows. The spoke tenons are inserted in the

rim by hand, being taken one at a time from the rod on which they hang at the workman's left, and then one spoke is grabbed in the press fixture vise and held hard by a long cam lever, all as clearly shown in Fig. 203, while riveting is done. The hammer is very fast, and the spoke slides down an inch or so while the riveting is done, which makes no difference as the atmospheric hammer follows it down all right. Riveting completes the rim and spokes, ready for assembling the entire wheel by adding the hub and side at the center of the bent

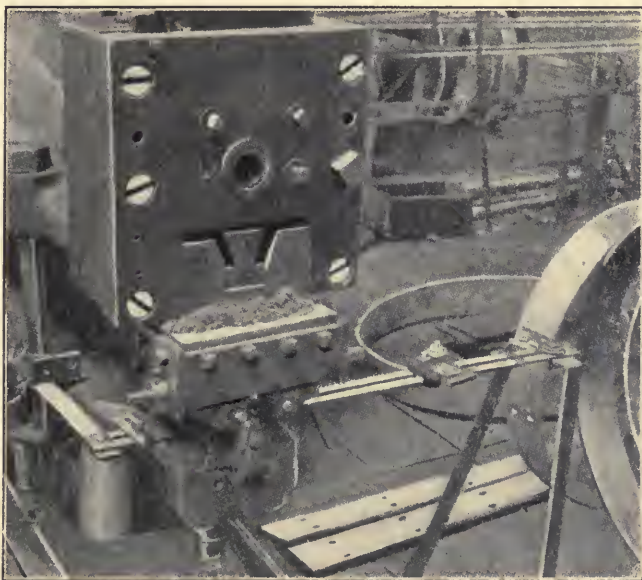

FIG. 202.—Spoke-forming press and tools.

spokes which are seen in the row of wheels on the floor at the left in Fig. 203, and also in the pile of larger diameter wheels in Fig. 204, in which the wheelbarrow wheels are shown stacked up at the right.

Making the Flanges

The flanges call for eight operations, for each one of the pair, blanking and piercing with a small central hole, then heating, then forming and cutting the central hole to finished

diameter, and finally piercing the flange for the eight rivets. It will be noted in Fig. 197 that the cast-iron hubs have a small triangular boss on one side. This touches both flanges and serves to locate the flanges and spokes midway of the hub length. This short boss might have taken the form of a circular flange, but this would increase the weight to no advantage.

The flange-blanks are heated to dark-red in a muffle having a bottom of broken fire-brick, kept red hot by a natural

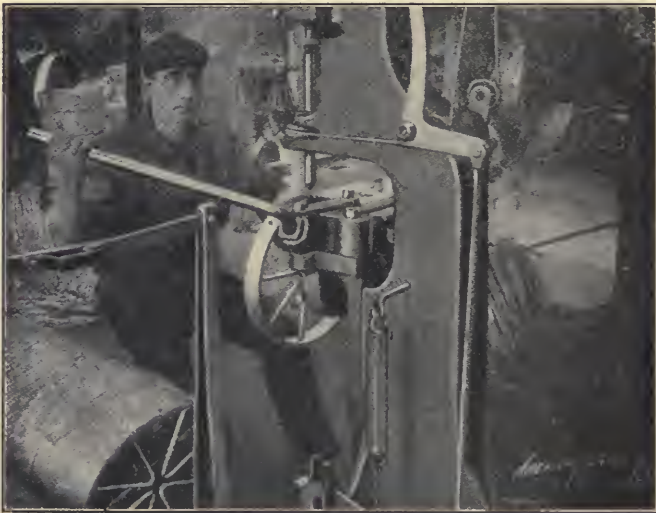

FIG. 203.—Riveting spokes in wheels. Air-power hammer.

gas and air-pressure fire, same general arrangement as the welding fire, all as clearly shown in Fig. 205, attended by a youth wearing London smoke goggles, who places the blanks on the muffle bottom and pulls them out with a long, slender, steel-rod hooked at the working-end, always keeping one blank heated red hot on the sill of the muffle-door at the left, ready to be taken with tongs by the pressman, who sits at the right of the press on a cushioned seat shown in Fig. 206, which shows the relative locations of the forming-press and the heating-muffle.

The flange-forming tools are shown in Fig. 207. The central plunger is spring-supported, and has three diameters at the top end, and, I think must have a first size for the two to fit the blank hole, next below that the cutting punch coating with a die in the press slide, and finally a straight part of the plunger, the diameter of the inside of the flange-hub. The hub blank, red hot, is placed on top of the spring plunger, the spring being stiff enough to cause the cupping of the hub before the plunger can be forced down; next in the press slides



FIG. 204.—Wheels ready for hubs and flanges.

downward travel, the ribbed die closes on the blank, shaping the flange as shown in Fig. 207. Flange-piercing follows, to fit the hub and spokes, and finally cutting the central flange hole to finished diameter the last thing, the ring chip formed by this last operation going up through the press-slide for escape. I am not sure about this operation, but it seems the only way, as the hole is enlarged and all the forming is done at one operation.

The last operation on the flange is piercing with an eight-

punch gang die, as shown in Fig. 208. This brings the job to the assembler, who uses a press, as shown in Fig. 209, first slipping a flange on an end of one of the hubs seen in the box at the left of Fig. 209, and then standing the hub upright in the bolster-die, and next laying the wheel-spoke inside ends in the flanges hard on the hub, everything being adjusted so that the descent of the press-slide forces the flanges hard on the hub and closes them hard on the spokes, ready for rivet-



FIG. 205.—Heating flanges in muffle, using natural gas.

ing, as shown in Fig. 210, taken from the pile of work at the right-hand of the assembling-press.

I do not recall the placing of the eight flange rivets, but think they are all headed down at one squeeze of the press, as the rivets are not very big.

The work is all very close and good, the fits are excellent, and the press-work gaging is very exact, as is shown by the symmetry of the spoke *V* in Fig. 197, and by the accurate

centering of the wheel-spokes in Figs. 203 and 204. Fig. 210 also bears witness to the excellent fitting of the rough parts, and Fig. 204 shows exactly flush with the tire outside the spoke tenon rivet. The completed wheel is very strong and very durable, and is really a miracle of construction when one stops to consider the number of operations the plant employed and the price per pound the work is sold for.

Supposing that steel-bars and gray iron-castings cost the Wheel Company $1\frac{3}{4}$ cents a pound, then the stock in an



FIG. 206.—Wheel-flange, muffle and forming-press.

$8\frac{1}{2}$ -pound wheel would stand for pretty nearly 15 cents, leaving 12 cents out of the 27 cents selling price to cover all expenses of performing the 29 principal operations required to produce the wheel, maintain the plant, and market the product.

I think I could easily make the plant of the Wheel Company's main floor cost \$1,000 more than it cost at first, with the sanction of the majority of toolmakers educated in New

England. I don't think I could cheapen the cost of the wheelbarrow wheels by increasing the cost of the plant. If I could not, I should certainly throw away whatever I put into the plant "betterment," which would not be a betterment at all, but worse than a dead waste, because the earnings must pay interest on it forever.

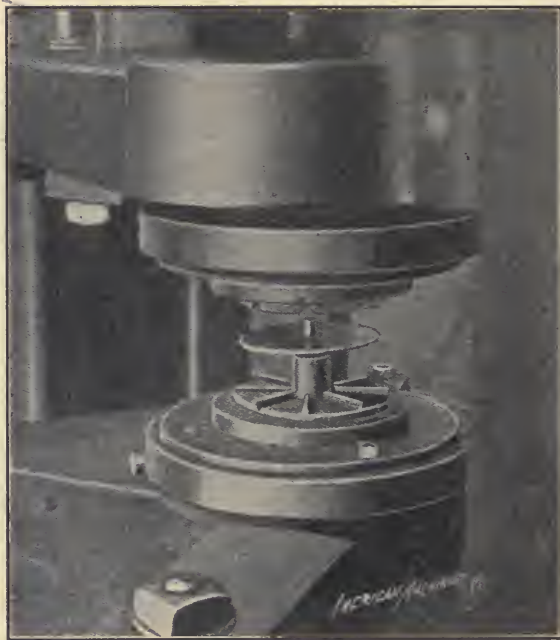

FIG. 207.—Flange-forming tools.

There are plenty of chances to think about things in the 27-cent wheelbarrow wheel job.

Pressed Steel Gears

An improvement in the manufacture of steel gears has been devised by Messrs. Ulrich and Fred L. Eberhardt, of Newark, N. J. The gears are primarily designed for street-car services, being made in halves for ready and easy clamping upon the axle or removal and renewal when necessary. Steel-cast-

ings have been widely used for this purpose, but not with perfect success, and it can scarcely be doubted that the present gears will prove to be superior.

The blank for each half-gear consists of a weldless steel-ring, Figs. 211 to 213. Each ring is shaped by pressure in suitable dies, being flattened down upon one side, the hub



FIG. 208.—Punching eight rivet-holes in flanges.

being shaped at the same time, until the perfect shape for the half-gear is secured.

How Metal Wheels are Made

When we think of machinery it pictures itself in shining surfaces, as though a large proportion of the machines in the world were of high finish, like watches and some marine engines. It is not correct. The greater portion of the work which is done in the world by machinery is done by rough machines. Much of this class of machinery is portable, goes on wheels, on the ground. Not much comment does it get

in the journals which are the vehicles of mechanical intelligence; but its progress merits occasional notice.

A change has taken place in the past fifteen years in the material of which many wheels are made. It was wood; it is now steel. As the utility and availability of metal wheels became more widely known the demand for them increased. Large manufactories, equipped with the most advanced tools and methods, have been established in the West, and annually



FIG. 209.—Assembling flanges and hub with spokes and rim.

consume for their product thousands of tons of steel. The strength, durability, and cheapness of metal wheels have made the manufacture of some machines profitable which would not have been on the market if these wheels had not been available. The wheels are made in commercial quantities for a great variety of machines: baling presses, binder master wheels, binder grain wheels, corn and other planting machines, corn shellers, cultivators, farm trucks, grain-drills, hay-rakes, ted-

fastened, and also in the different forms, sizes, and complications of the design in the hub, which, formerly satisfied with two parts, the spoke-shell and the spindle-box, are now more involved since roller bearings have come into use.

From hub to tire the wheel is the prey of innovation. It is always liable to have some new thing put on it anywhere, even outside of the tire. The motor wheel of an agricultural machine must turn around, for if it slides on the ground the mechanism is inactive. Therefore these wheels are provided with spurs which settle into the ground and prevent sliding. These spurs are attached to the tire, are of many forms and

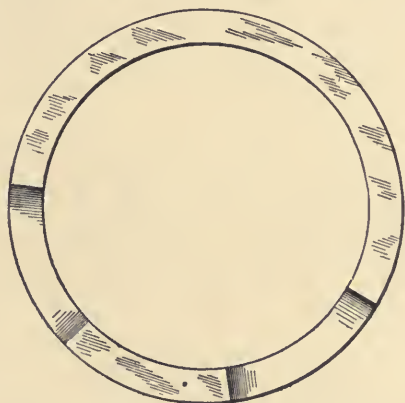

FIG. 211.—Pressed-steel gear.

attached in many different ways. In a single metal-wheel manufactory there are made no less than 1,500 different styles of wheels.

Wheel Tire Making

The principal form of corn-planter wheel tire was for some time that shown in Fig. 214. It was 5 inches wide and from $\frac{1}{8}$ inch to $\frac{1}{4}$ inch thick. The concave was $\frac{3}{8}$ inch deep. Not more than twenty years ago I took a day on purpose to see them welded under a trip-hammer. These were heated by a hard-coal furnace under the narrow cap which projected over the slotted top, through which the flames were driven on

to the tire. It was a good arrangement for the time, but the tires are welded ten times as fast now by the use of electricity and other later improvements.

A binder master-wheel tire had a cross section like Fig. 216. It was 9 inches wide after bending the flanges down $1\frac{3}{8}$ inches, and was $\frac{3}{16}$ inch thick. Another binder main-wheel tire is shown in Fig. 217. It is 9 inches wide, $\frac{3}{16}$ inch thick in the middle, and the sides are $\frac{7}{16}$ inch thick. The wheel is about $3\frac{1}{2}$ feet in diameter. A favorite form of cultivator tire is half oval, as in Fig. 215, $1\frac{1}{2}$ and $\frac{5}{16}$ inch thick in the center. When they were made by hand it was more convenient for welding to have them of flat cross-section, but when they are welded in dies the shape of the cross-section is

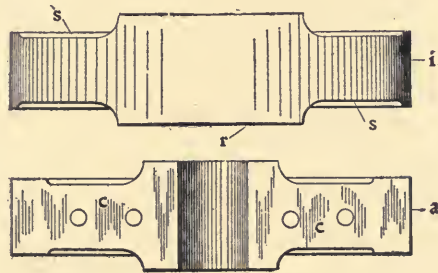

FIG. 212.—Pressed-steel gear sections.

of little consequence, as the dies can be made to weld one form as well as another.

Many corn-planter wheels are now made with double tires and open centers. Fig. 219 shows the cross-section of the two tires riveted to the spoke. They are 2 inches x $\frac{1}{4}$ inch, and some 800 is a day's work at welding them into flat tires 30 inches in diameter. They must be well united, for when they are cold they are put in the dies of a hydraulic tire shrinker and the six jaws close around them with a forty bear-power hug, and in some fraction of a minute one edge of the tire has been contracted so that one side of the tire is an inch and a half less in diameter than the other. That side of the bar has been contracted nearly five inches.

One would suppose such an expenditure of force would produce quite sensible heat, but when it is felt for with the bare hand there is found so little heat that it requires faith to perceive that there is any. Nor is any heat developed in the machine, although the operation is repeated every two minutes, as it compresses 300 a day. This is not a case for comparison between machine work and that done by hand, and no comparison can be instituted. If machinery was not available these wheels would not be made. These tires, which have to be compressed after welding, are now punched as the first operation upon them.

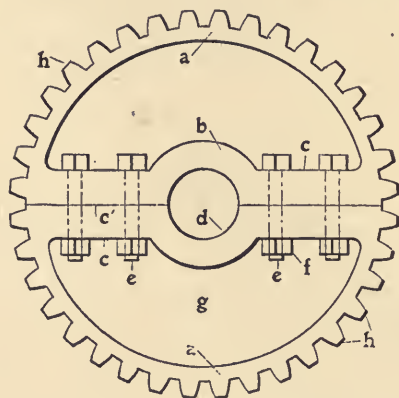
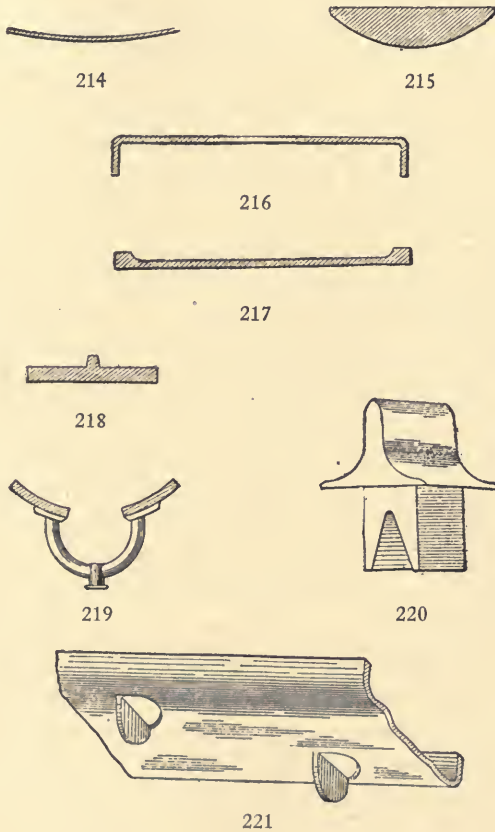

FIG. 213.—Pressed-steel gear.

The multiple punch displays its advantages by punching all the holes in some tires at one stroke. There are eight holes in a cultivator tire, and it punches 1,200 tires a day. The tire shown in Fig. 214 has twenty holes, there being two rolls of spokes with ten spokes in each row. These holes are punched on a common punch-press, the dies of which, however, are so made that they punch four holes at a stroke and with this arrangement upward of 150 tires are punched daily.

When one machine does a lot of work a lot of work stops when it stops. For instance: Once there was a multiple punch, punching five holes $\frac{5}{8}$ inch diameter through steel $\frac{5}{8}$ inch thick. Now, it is easy to vary the length of the punches a little, so that the whole strain may not come at once, but it was not thought that the punch needed humoring, although the shear strain was about equal to punching a hole 3 inches diameter. There had been foul work on the punch before, and there was known to be a slight crack in one of the uprights. This time came a bar which was as hard as though

it had been hardened. It was the first time to decide the question whether the machine would stall or break, and the balance-wheel did not stop to give the question any consideration. There was quite a loud report; no very great disorder.



Figs. 214 to 221.—Details of metal wheels.

The upright simply let go and the upper part raised up enough to permit the revolution of the eccentric, and the machine was thoughtfully thrown out of gear. The balance-wheel came to rest after a while, and when the new upright came and was set up, no one would know anything had ever

happened, except for the pile of work that was behind hand to prove that a machine that can do such work can stay working.

Perhaps nothing could give a better idea of the amount of time that is void of visible product than the output of some machine which makes regular strokes, and makes a piece at every stroke if the work is fed to it. Of this kind are the bolt machines, used for making the collar-head end of the spoke which is to be riveted in the tire. They can head a spoke at every stroke and run 36,000 strokes a day, and 17,000 spokes a day is the very best day's work that has been done on one, although when everything is in good running order every stroke is easily caught. The fuel is gas, the fire constant and uniform, and a pair of well-hardened dies of good steel will last half a day without changing. Open hearth steel is used for spokes exclusively, after years of experiment, as its uniformity can be depended on.

One successful process of making metal wheels is the preparation of the tire by punching the spoke-holes and bending the malleable-iron hubs hot, with a machine that throws out a collar outside of the hub at the same time that it rams up a head in a recess on the inside. These machines head several thousand spokes in the hubs in a day, from six to twenty spokes in a hub. The rims or tires are then put on, and the spokes are riveted in them cold, by riveting-machines. They can pass into the adjuster's hands, who takes the kinks out of them so that the lap of the tire fits for the welder. They are heated on a gas furnace for welding. It has three fires attached to a central standard, around which they are revolved as wanted. When a tire is at a welding heat, the fire is holding it where it can be conveniently lifted out and dropped on the die of the welding-hammer. The spark shield is instantly in place, and the quick running-hammer makes the weld, while the operator moves the tire to receive the blows to the best advantage. The wheel is then handed to the trimmer while the welder places another tire in the furnace and swings it away, bringing the tire that is hot into its place. Some of the light tires are welded at the rate of two in a minute, and some

on wheels that weigh 375 pounds each require as much as five minutes to a weld. The trimmer trims off any fins that may have raised, and trues up around the weld. The spindle-boxes are very forcibly set in the hubs after the tires are welded. The hubs thus being reinforced are prevented from being cracked by the strain. A general inspection and truing up follows and completes the process.

The spurs are sometimes pieces of malleable iron which are put on the outside of the tire, from one spoke to another, diagonally across on a double-spoked binder-wheel. The ends of the spokes pass through and rivet the spurs on with the tire. Setting them anew is supposed to prevent the wheel from sliding sidewise on a side-hill. Some malleables are made that form a rib around the center and spurs on each side. Some tires have the rib rolled on, as shown in Fig. 218. It is 4 inches wide and $\frac{1}{2}$ inch thick. On narrow wheels a form of spur is used, shown in Fig. 220. The shoulder is about $1\frac{1}{2}$ inches square, and the spur an inch high. The split shank is easily riveted into holes punched for the purpose between spokes and spaced about 5 inches apart. A 30-inch wheel with tier $3\frac{1}{2} \times \frac{3}{16}$ had lugs punched free on three sides and bent up, as shown in Fig. 221.

Three traction engines recently sent to Cuba had driving-wheels built of steel-plate by the manufacturers of the engines. They weighed $3\frac{1}{2}$ tons each, or the pair to each engine weighed 7 tons. They were 8 feet in diameter and 2 feet face. Each had 36 lugs, 4 inches wide, $1\frac{1}{4}$ inches thick, riveted diagonally on the tire and extending the full width of the wheel. Contrary to general practise, the spaces occupied by the lugs were greater than the spaces between them, which would indicate that they were designed as much to protect the $1\frac{1}{2}$ -inch steel tire as to improve the traction. The front wheels also were built up of steel-plate. They were five feet in diameter and 15 inches face. The weight of each engine was 25 tons. They were to be used for transporting sugar-cane. The wheels on the wagons they were to draw on public roads were 6 feet diameter, 13 inches face; hub, 12 inches long; double row of spokes cast into

hub and bolted to tire; spokes, $3 \times \frac{1}{2}$ inch steel. A few of these traction engines rolling along the paths of industrial progress would have a weighty influence in settling that commotional isle.

Steel Wheels

Steel wheels for use under various agricultural implements, engines, etc., have within the past few years almost entirely

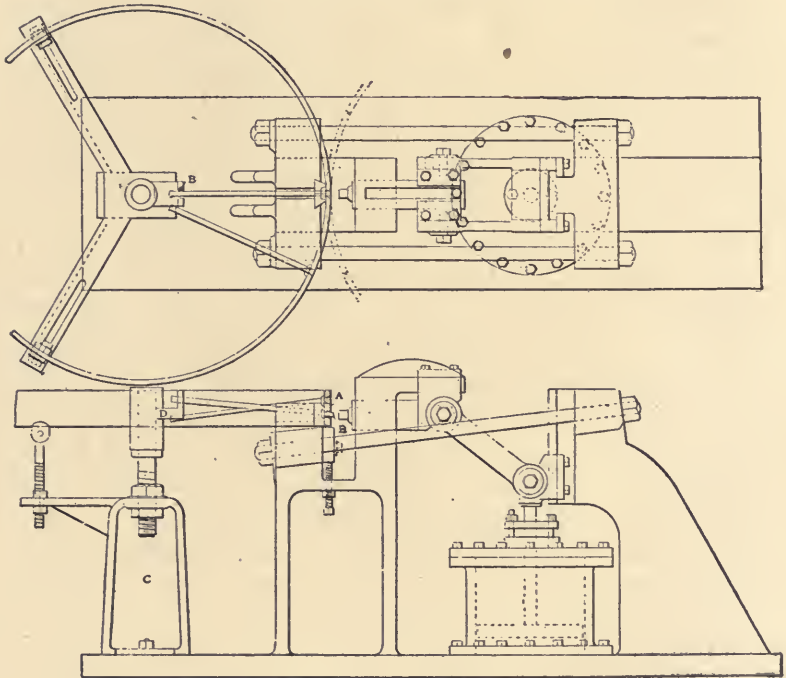

FIG. 222.—Punching holes for the spokes.

superseded the wood wheels—both those with wood and those with iron hubs. This has been due to the demand for a wheel that would withstand the heat of the sun as well as that of a steam-boiler. The immense number of such wheels used has made it necessary to provide improved machinery and to adopt systematic methods for their manufacture. Any factory using such wheels can well afford to do this, if not less than

three or four hundred are wanted per year. The manufacture of such wheels may not be in the line of machine-work, but the construction of the necessary tools and appliances and the manner of using them may be useful and interesting to some of my readers.

Fig. 226 shows the elements of a wheel of which a large number have been used, yet one which is not satisfactory.

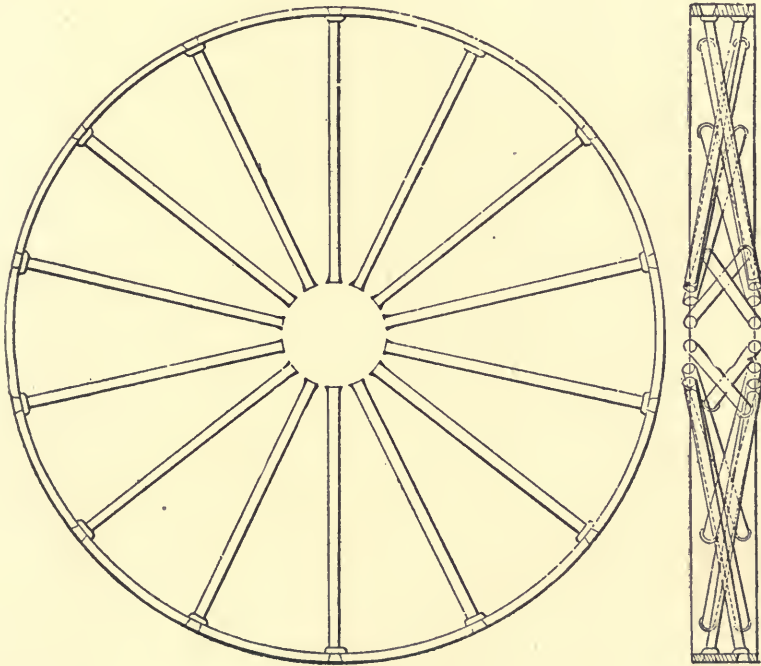

FIG. 223.—Rim and spokes of wheel as they come from machine.

The spokes, having no collar on the inside of the rim, and being fastened to the hub by nuts, as shown, are continually working loose. This wheel is also very expensive.

Fig. 222 shows the outlines of a riveting and punching machine used in this work. Fig. 223 represents the rim and spokes of a wheel as they come from this machine.

Fig. 224 shows an enlarged section of the rim with the

spokes in place, one of which is riveted and the other to be riveted.

Commencing at the beginning of the various operations, we will follow the wheel through to a finish.

The tire, or rim, as we shall call it, is first cut to length, bent and welded in the usual way, after which the various improved methods and tools come into use. No attention is paid in the first operation to having the rim exact as to diameter. It is placed in a hydraulic tire-setting machine (bought and used primarily for setting tires on wooden wheels), where it is forced to size and made practically a true circle. This operation is completed in less than five minutes.



FIG. 224.—Enlarged section of rim.

The next operation consists in punching the holes for the spokes, which is done in the machine shown in Fig. 222. It will be noticed by Fig. 224 that the holes are tapered. The taper is obtained by using a die with a hole of the same diameter as the large end of the hole, the punch being the same as the small end of the hole; or, perhaps, to make my meaning clearer, we use a die as much larger than the punch as the taper desired plus the clearance usually used with punches and dies.

The rim is first placed in the machine, as shown by dotted lines $x x$, and as the holes are staggered, the spacer (not shown) is set for one-half of the total number of holes required, and, to complete the operation, the rim is turned over to punch the other half. The spokes are cut the proper length, allowance being made for material to form the collar shown. This is done in an ordinary bolt-header, the other end being flattened by a blow from a small trip-hammer.

The spokes and rim are now ready to go to the riveter. This machine is supplied with a stand C , on which is mounted a casting D , which is slotted, as shown at B . This slot receives the spoke and holds it in proper position for riveting.

A wheel rim is shown in place, with spoke *A* riveted and *B* in position. The ram of the machine is supplied with a flat end punch of considerably larger diameter than the hole in the rim. A heating furnace is placed convenient to the operator. Suspended over the center of the rim is an air-lift. The die for receiving the spoke is split and connected, as shown at Fig. 225 by a steel spring (not shown on Fig. 222). This spring is used to enable the operator to handle the die easily and to open it automatically, when the rim with the riveted spoke is lifted to be turned round to secure another spoke. After every alternate spoke is thus riveted, the rim is turned over and the operation is finished. The die has a cavity for receiving the collar on the spoke, keeping it in good shape while the end is forced to fill the taper-hole.

This method of connecting the rim and spoke is, I think, the best that can be devised. The rim and spokes thus put together are shown by Fig. 223, as they appear when ready to receive the hub.

In the operation of riveting the spokes into the rim, the workman takes a spoke from the furnace with his left hand, holding the die in his right. Closing it over the spoke, he places the other end of the spoke in the slot of the false hub, at the same time placing the die in position. After releasing it, he adjusts the rim in position, so that the spoke will enter the hole, holding the spoke firmly in the slot of the false hub with the left hand and operating the valve with his right. The valve and lever are not shown. The piston may be operated with steam or compressed air. In this case air was used.

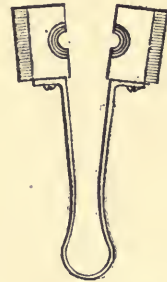

FIG. 225.—Spring clamp for spokes.

Early History of Chain-Making

Just when chains were first made is uncertain, because the word has meant almost any kind of connection. Thousands of years ago rings of metal were made and fastened to cloth, thus making chain armor. Later, rings were joined together

by other metal rings, and this was the first metal chain. Apparently chains were used more as ornaments than anything else up to about one hundred and twenty-five years ago, although occasional patents have been issued during the past two hundred and seventy-five years. The first patent the author has knowledge of was issued in England in 1634 and described as follows:

“A Way for the Mearing of Shippes with Iron Chaynes by finding out the True Heating, Ppaeing and Temping of Iyron for that Ppose, and that he hath nowe attained to the True Use of the said Chaynes and that the same wilbe for the great saveing of cordage and Safety of Shippes, and will redound to the Good of our Common Wealth.”

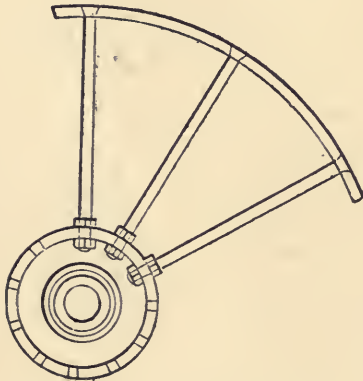

FIG. 226.—Complete detail of construction.

A New Method of Making Weldless Chains

The weldless chain, in the form of the common plunger's or "safety" chain, is a familiar article. It is said to have been devised originally by the inventor of the first watchman's time detector as the means of fastening the

various keys used in the system, scattered at different points about the premises. A chain of this sort can only be "unraveled" from one end, and if that end is sealed with the image and superscription of the owner, the task of deception is a difficult one.

Iron chains of large sizes have been made on the same principle, but more for reason of strength and ease of making than for safety. It is a point gained when the weld of the ordinary chain-link is avoided, since its strength can never be prophesied beforehand, and the whole chain, in the words of the common proverb, is "no stronger than its weakest link."

As such chains have hitherto been made, however, it has always been necessary to make the opening in the outer link long enough to admit the next link to be added to the chain. While this elongated link does very well on sheet-metal plumber's chain, it is a source of weakness in chains of wrought iron or steel, of large sizes, intended to support large loads. When such a chain passes over a sheave or around a sprocket, the bending stresses set up in the long links quickly deform them and spoil the chain. The object of the invention of a Hungarian—Stefan Kiss v. Ecseghy, by name—is to make

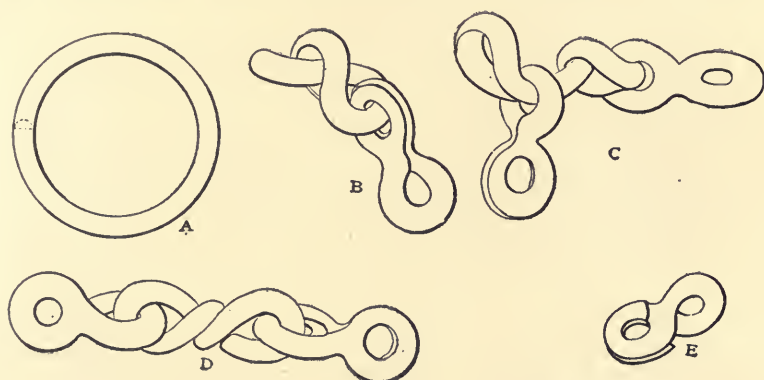

FIG. 227.—Details of new short stiff-link chain.

it possible to produce chains of this kind with very short, stiff links.

The shape of the chain is shown in Fig. 227. As will be seen, each link is double, being formed of two loops being split. The method of forming the chain is shown in Fig. 228. The secret of the process is shown in the first operation. Fig. 227, at *D*, shows a complete link, and *A* the blank from which a new link is to be formed. As will be seen, this is made of stock somewhat larger than the size of the chain, reduced in its central portion to that size. These blanks may be made by drop-forging rolling or any other commercially suitable method. One of them is heated in the forge and inserted in the end of the already completed portion of the chain, as shown. The ends are then struck up under dies to the shape

shown in operation 2, where *E* is the end of the finished chain, and *B* the new link being formed. It will be seen that the hole in the old link is but slightly larger than the diameter of the stock composing the new one, while the new half links in the end are of considerably greater size. It would evidently be impossible to insert them if they were formed before insertion, hence the process of inserting the blank first and form-

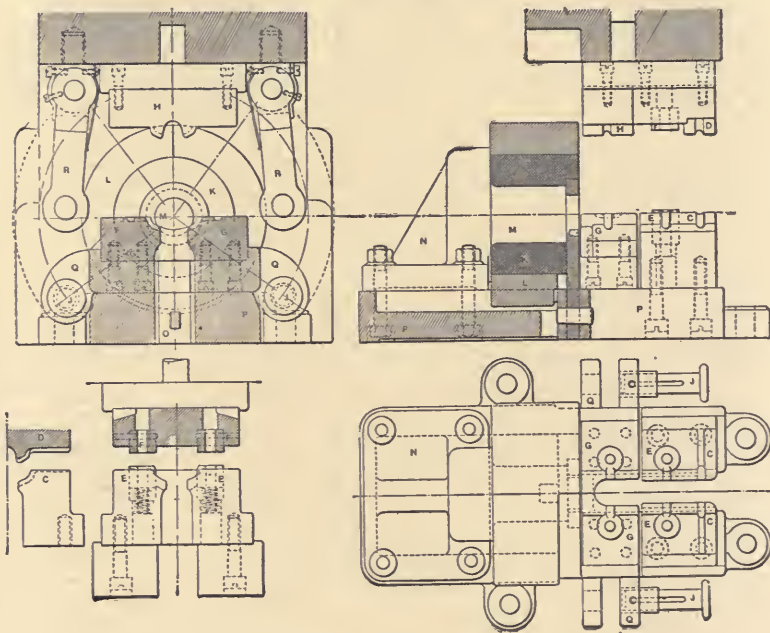

FIG. 228.—Dies for forming chain, Fig. 227.

ing it afterward. This is the vital principle of the patent. As shown in the third operation, the ends are next bent around to form the new complete link, which is thus made ready for the insertion of the next blank.

Dies for Weldless Chain

Fig. 229 shows the dies used for doing this work. The press shown is of a type common in Europe, though seldom, if ever, seen in this country. The two friction-wheels on the

horizontal driving-shaft may either of them be shifted to engage the rim of the heavy balance-wheel attached to the vertical screw. The screw raises and lowers the ram of the press. The operator controls the friction-wheels by the

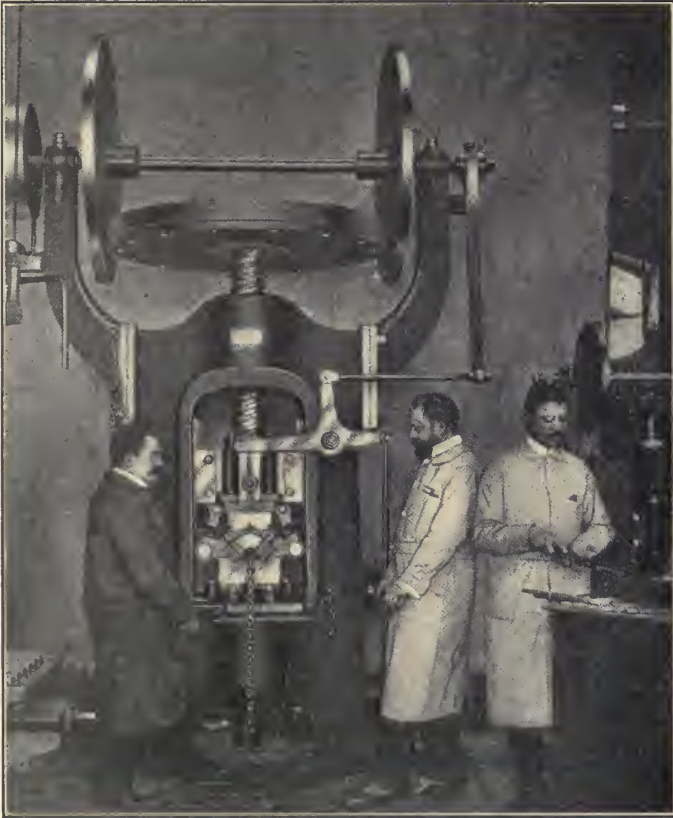

FIG. 229.—Screw-press with friction fly-wheel used in chain-making.

handle shown, or by the treadle at the base of the machine. A stop on the ram automatically throws out the disk controlling the elevating motion, and stops the ram at the upper limit.

The dies used in this press are shown in Fig. 228. With

this arrangement, three operations are necessary for the forming of the completed link, these operations corresponding to those shown in Fig. 227. The complete portion of the chain is suspended over a pulley from the ceiling with the free end in the easy reach of the operator of the machine. A heated bank of the link shown in Fig. 227, operation 1, is taken from the forge, inserted through the link, and placed in dies *C C* on the bed of the press. Ram *D*, shown best in the small detail at the lower left-hand corner, is then brought down on the link, flattening out the ends and curving the central portion. The plunger is raised again, the link is moved forward to dies *E E*, and the plunger is again brought down. The die at *E* is compound, and punch *F* above it, descending on the work, forms the rounded half links on the end of the blank, punches the hole, and trims off the periphery of the work.

The ram of the press is raised for a third time, and the now completely formed (but still open) link is moved to the bending-dies at *G G*. When the ram of the press is brought down on the work at this point, after smoothing the work under the pressing action of punch *H*, pins *J J* are pushed in by the operator, entering holes in links *R R*, which are then in position to receive them. Of the two parts, *G*, the one at the left in the left-hand view, is fastened to the holder integral with ring *K*, while the other one is supported in a similar manner from ring *L*. These two rings are free to rock about each other and about the pivot *M*, formed in the bracket casting *N*, attached to the bed of the machine. A tie-bar *O*, keyed on the base *P*, serves to support the overhanging pivot *M* of bracket *N*. A support not shown in the cut extends out over the finished portion of the chain through which the new link passes, and supports it against the upward pressure of the bending operation which now takes place. When the ram of the press is started upward, links *R* attached to it, draw after them die-holders *Q Q*, which rock as described about the axis of pivot *M*. By this means the link is bent finally into its complete form, as shown in operation *D* of Fig. 227.

The half-tone, Fig. 229, shows three operators. This is

not necessary, however, as one of the men shown is there probably, merely for the sake of having his picture taken. A boy to tend the fire, and a smith to work the press, is all that is required. The machine is started and stopped by the treadle. The man at the extreme end is the inventor.

The writer has had the opportunity of seeing this process in operation. The tools used were somewhat different from these shown, and more operations were required, although the basic principle involved in the invention was identical. The new link of the chain, which was of half-inch size, was bent in the die *C*, as described, but in the die *E* the ends were merely rounded, and the central hole formed nearly through, without being actually punched. The new link was then closed up in a third operation as before. These operations took place in a press of the same type as shown in Fig. 229. The unfinished shed link was next taken to a small crank-press standing beside the larger machine, where first the central hole was punched through, after which, for a completing operation, the link was pushed through a trimming-die to have the fin shaved off. This resulted in an exceedingly neat and clean-looking link, with the joint tightly closed and smoothly finished. The operation of forming the link for a half-inch chain takes 25 seconds.

Besides the obvious rapidity of making chains by this method, there is the more important advantage of greatly increased strength. The British Government requirements for chains insist on a factor of safety of 5, owing to the unknown quantity of the strength of the weld. A good welded half-inch chain fails at about 13,000 pounds. Samples of this improved weldless type were tested at about 16,000 pounds when made of wrought iron, and they run with remarkable uniformity at about this load, showing that a higher factor of safety could easily be used. Furthermore, the use of steel is made possible by the fact that a welding heat is not required. A heat intense enough to weld steel will decarbonize it, so that it has not the strength that it previously possessed. Steel is especially useful in crane service, where durability is fully as important as strength. A wrought-iron chain will wear and stretch until it

will not fit the sprockets, long before it breaks. Steel chains made by this new process test at about 21,000 pounds for $\frac{1}{2}$ -inch side. Fractured samples seen by the writer failed at the sides of the links, and not, as might be expected, at the point where the two parts of the same link come together. An interesting point is the fact that the two halves of the split link begin to separate a little while before the final rupture takes place, thus serving as a sort of safety indicator to apprise the user of the fact that he is near the danger limit.

This invention is controlled by the Internationale Handelsgesellschaft, Kleineberg & Co., and is for sale in this country by the International Import and Export Company, of No. 1 Madison Avenue, New York City.

Modern Methods of Manufacturing Welded Chain

It is not perhaps generally known that the United States is not only the largest producer, but also the largest consumer of welded chain in the world, and that its annual production reached, in the year just ended, the 60,000-ton mark. This industry is probably one of the best examples of large growth made possible by the introduction of the latest types of labor-saving machinery. The increasing demand for this product, which was greatly in excess of the production in 1901-2, resulted in many plants being started in the following year, and 1904 found the production slightly in excess of the consumption. The present era of prosperity and the general resumption of all manufacturing business finds the production of welded chain greater than ever before, and the prospects for a most satisfactory year are of the brightest.

This industry is what one might call a transplanted industry, as in former years England supplied us with all our chain, but our consumption reached such proportions that it was found necessary for us to enter this field as manufacturers. As an accompaniment of the transplanting, the processes and the product have been corrected, improved, and developed until to-day American chain is recognized as a standard.

The manufacture of chain requires essentially skilled labor

and the most modern machinery, as on these depend not only quality of the finished product but also the low cost of the production. The illustrations given herewith show three of the latest and most important examples of labor-saving machinery, devised and adapted to meet the demand for greater production and better quality.

In order that the value of these three machines in modern chain manufacture may be more clearly seen, the old method of manufacture, as it is still carried on in some parts of Europe, will first be described.

Former Method of Making Chain

Taking, for example, the way in which $\frac{7}{8}$ -inch common chain was formerly made, we found that the smith placed in his fire several pieces of $\frac{7}{8}$ -inch straight, round iron which has been previously cut to the required length. As one of these reached the proper heat, about a cherry-red, it was withdrawn, one end placed in a hole in the anvil, the bar hammered with a hand-hammer into a rough U shape, and then placed back in the fire for another heat, and in the meantime another piece which had been heated was bent into the U shape, and so on.

The first U-shaped link, having reached almost a white heat, was taken from the fire, its open end hooked through the link last welded, laid flat on the anvil, and one end of the U link drawn with the hand-hammer to a taper of about 60 degrees with the diameter of the bar. This was called scrafing the link, and when one end was thus scrafed the link was turned over and the other end scrafed in a like manner, so that both ends were drawn to a taper, but on opposite sides. The link was then placed on the horn of the anvil and the ends bent toward each other, so that the scrafed ends lapped, after which it was laid flat on the anvil, and these scrafed ends hammered closely together. This process completed the oval shape of the link, and it was placed back in the fire for the final and welding heat. When this was reached, the link was withdrawn from the fire and the scrafed ends were welded as

the link was turned over and back, so that every portion of the part of the link being welded should receive the proper working that was necessary to secure a perfect weld. By this process the smith could not weld over 250 pounds of $\frac{7}{8}$ -inch common chain per day, this being equivalent to 31 feet, or 156 links as a day's work, and while the quality of the chain produced in this manner was of the best, it was found that by performing part of the labor by machinery the production could be quadrupled and the quality bettered.

Present Method of Making Welded Chain

Under the present process of manufacture, we find that the long bar is now wound into a spiral of links on a link-winding machine, and then cut up into links on the link-cutting machine, the cutting process forming the scrafs on the ends of the links, and doing away with two heatings of the iron that were necessary under the former process, as the winding and cutting are done with the iron cold.

The Link-Winder

The link-winding machine, Fig. 230, consists of a horizontal shaft about 4 feet long, which is operated by a belt and pulley geared to one end, while on the other end is attached the winding mandrel or link-former. This mandrel can be changed according to the links that are to be wound, and has outside dimensions conforming to the inside dimensions of the required link. One end of the bar of iron is fastened over this mandrel by a movable attachment, and a grooved guide-wheel is lowered to meet the bar and press it firmly on the mandrel by means of a powerful spring. As the machine is started, the shaft slowly revolves and the iron is wound tightly around the mandrel in the form of a spiral of tight spring, the pressure of the grooved guide-wheel forcing the iron to conform exactly to the desired shape. When the bar has been entirely wound up the result is a spiral link about 6 feet long, ready to be cut into links. By means of this

machine 9,000 pounds of bar iron can be wound into spirals in one day, equal to about 5,000 links. In some rolling mills which supply chain manufacturers with rods, they have link-winding machines placed so that the bar of iron can be wound

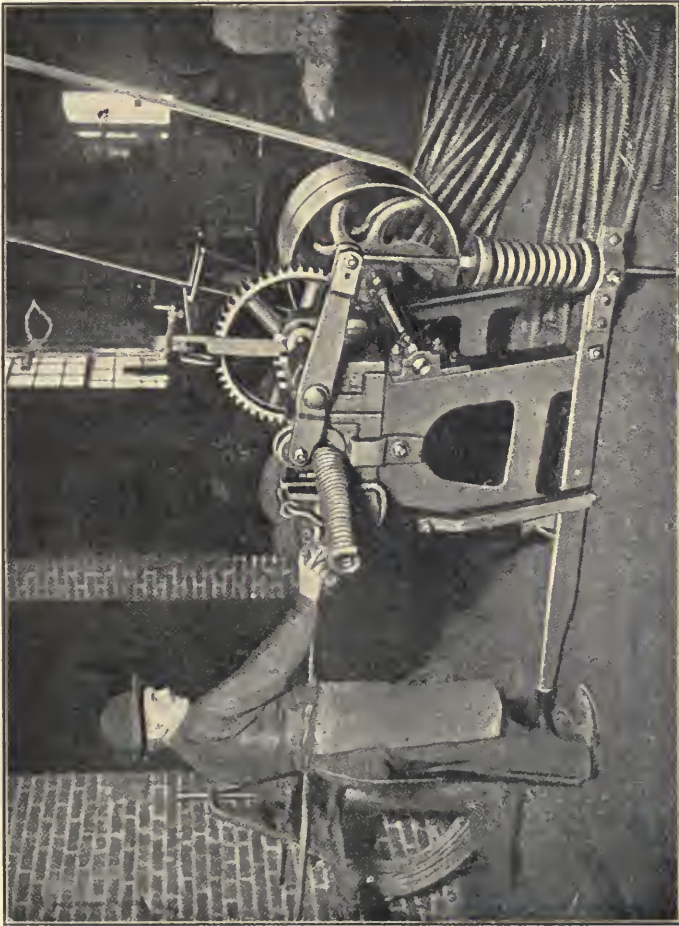

FIG. 230.—Link-winding machine.

hot into spirals as it comes from the rolls, as by so doing the link-winder can be run at a higher rate of speed, resulting in greater daily production and with less waste than by cold winding.

The Link-Cutter

The link-cutting machine consists of one fixed lower cutting-blade and one sliding upper cutting-blade, which slides in a groove and is operated by belt and pulley gears. The spirals are fed into the cutting-blades from the left side of the cutter and held in such a manner that the iron is cut at an angle of 60 degrees with the diameter of the rod, each cut releasing one link, wound and scrafed ready for welding, and at the rate of one cut every second, or 36,000 links per day.

The Welding Machine

The power-hammer on which the chain is now welded is shown in Fig. 231 and represents the results of years of experience and trial. When the idea of welding the links of a chain by means of dies instead of by blows of hand-hammers was first conceived, a foot-power hammer was attached to the anvil, the hammer being hinged on the opposite side of the anvil from the smith and so arranged that by kicks on a foot-treadle the smith could swing the hammer-arm down to meet the face of the anvil. In the lower face of the hammer-arm was attached the upper die, and on the face of the anvil. In the lower face of the hammer-arm was attached the upper die, and on the face of the anvil was attached the lower die, the result being a smooth finish superior to that of a hammer-welded link. This was a big step in the right direction, but it was soon found that on large sizes of chain the labor of operating the hammer-arm by foot-power was too great and the present well-known type of power-operated hammer was devised to obviate this difficulty. The power for operating this type is conveyed to a pulley on the hammer-base by means of a belt from the shafting of the shop, arranged to give the hammer a speed of about 120 strokes per minute. The weight of the hammer-arm is in its head, and the force of its blow is due both to gravity and to the pulling-power exerted by a powerful spring. The machine is so arranged that when not in use the arm is raised about a foot from the face of the anvil and held

there by a catch, so that when this catch is removed by a pressure on the foot-treadle, the hammer will fall heavily on the face of the anvil. The pulley on the hammer-base operates a short shaft carrying an elliptical cam, and is so arranged that when the hammer-arm is caught and held up from the face of the anvil the cam will not meet the base of the arm, but when the arm has been released and descends on the anvil the base



FIG. 231.—The welding-hammer.

of the arm is brought within reach of the rotating cam, which strikes the base of the arm and raises the arm about a foot from the anvil, when further rotation of the cam releases the arm and permits it to fall again. This operation continues until the link has been welded, when, by releasing the foot-treadle the arm is caught and held up until another link is ready to weld. By means of this hammer 1,000 pounds

of $\frac{7}{8}$ -inch chain can be welded in one day, equivalent to 124 feet, or 626 links, being four times the daily production under the old hand process.

The Die

In regard to the dies used, the lower die consists of a block of steel cut away until a small rounded projection is left which will just fit inside the end of the link, while the upper die is a block of steel hollowed out so that it will just fit over the outside of the end of the link, the space between the two dies being just the size of the end of the link which is to be welded.

These dies are fitted in spaces left in the face of the hammer-head, and the face of the anvil, so that different size dies can be used on the same power-hammer, according to the size chain that is to be welded.

The Process of Welding

The smith selects from the several links in the glowing bed of coke in the furnace one that has reached the welding-heat, and hooking it through the link last welded, places the open end of the link over the lower die. Pressure on the foot-treadle releases the hammer-arm and the impact of the blow forces the scrafed ends closely together and welds the link, the dies reducing the body of the weld to the same size as the rest of the link and giving the weld a smooth, finished appearance, superior to a hammer-welded chain. About ten blows of the hammer-arm are required to make and finish the weld, the interval between the blows of the arm being utilized by the smith to turn the link over and back on the lower die and to lightly tap the weld with his hand-hammer, thus giving the proper working necessary to secure a perfect weld.

The use of these three important machines has completely revolutionized the process of chain manufacture, the result not only being increased production, but also a much better grade of chain at a greatly reduced cost.

CHAPTER VIII

FORGING MACHINE, STEAM-HAMMER, BULLDOZER, AND SWAGING MACHINE METHODS AND PROCESSES

Handy Bulldozer Appurtenances

THE bulldozer, or bending-machine, is at present found in almost every car, railroad, bridge, and agricultural shop in the country, and as a time-saver and all-around tool for wrought-iron work it stands preeminent. Long experience with this machine and with the varied methods used in different shops have given opportunity to judge of the easiest and best methods for doing work on it.

A back plate (Fig. 1, of whole Fig. 232) is dispensed with in many shops using this machine, but why, unless it is ignorance of its utility, is unknown, as it is indispensable. Having introduced it in several shops, it has always been retained, and the wonder has been how they got along without it before. It keeps the work straight, saves a great deal of gray iron; and it is much easier to fasten the forms to than the bed of the machine.

By making a divided apron, or flat part, as in Fig. 2, and casting a lug on the bottom, see Fig. 3, its usefulness is increased and the plate is lightened for easier handling. The plate should be made plenty wide enough to take in the longest work done on the machine and the face and apron should be planed perfectly true. A depressed fillet at *A*, Fig. 2, allows a former to always go snug against the back. Two bolt slots in the back are better than having to drill new holes to fasten the forms. The holes in the forms can be cored to suit, or drilled as desired.

The plate on the ram head is shown in Fig. 4. It should have tongues cast to fit the crosshead firmly, so that there will

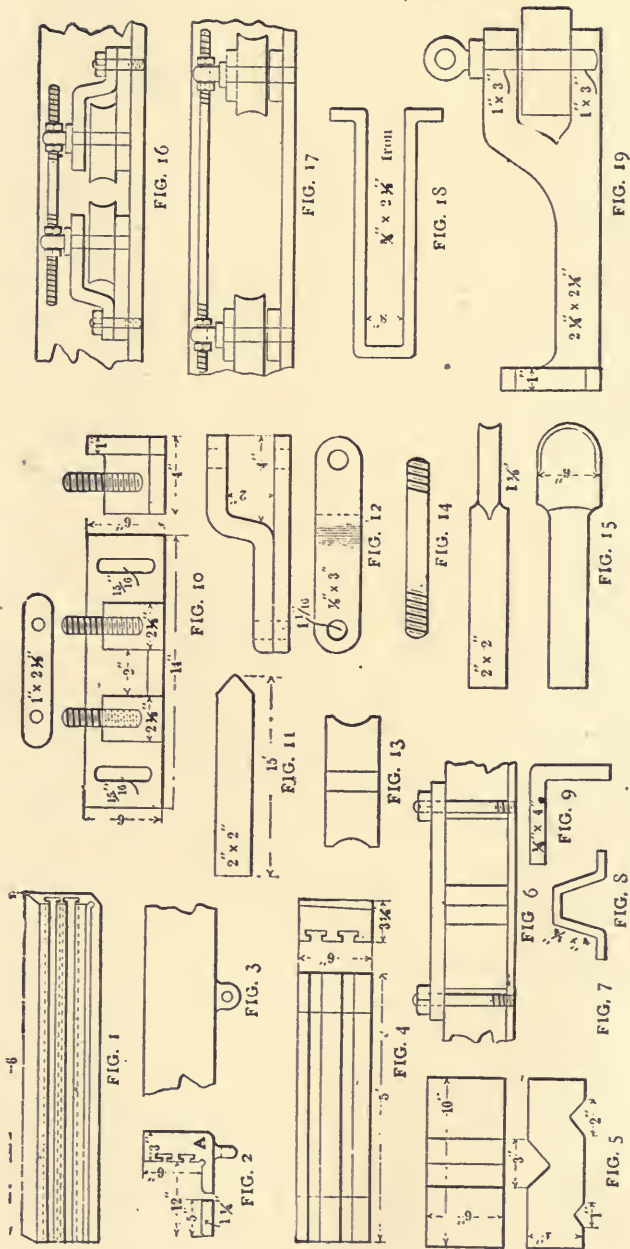

Fig. 232.—Bulldozer appurtenances.

be no side movement. It should be about 12 inches shorter than the back plate. The bolt slots should be for $\frac{7}{8}$ -inch bolts, allowing them to slide easily. This applies to the back-plate as well.

A V-block, Fig. 5, serves for a great variety of formers if properly made, as an angle to 45 degrees can be bent, and most of the work can be done cold. The block should be made of tool-steel, hardened. A cast block gives good results, but of course wears much faster. The block should be of the dimensions given in Fig. 5 and as wide as may be required for work done in the shop; the small Vs at back are for lipping and turning gibs. The block is fastened on the back-plate by two $1\frac{1}{8}$ -inch studs screwed into the plate on each side of the block, with a $1\frac{1}{4}$ -inch strap for a compression-bar. Fig. 6 shows the arrangements. Holes for the block should be provided also on the operating side of the machine, about 12 inches from the end of the plate, so that long work can be done. Otherwise the head would catch the iron when the plunger was in action. Figs. 7, 8, and 9 show samples of work done *cold* with this simple device.

The plunger and socket are the next consideration. The socket is shown in Fig. 10, with the strap for it. The long slots are provided for raising or lowering the plunger, as this part needs a variable adjustment. The back should be machined, so that it will be lined up at perfect right angles with the crosshead.

The plunger can be simply a piece of 2-inch square iron with a piece of tool-steel welded into the working end for a nose; wide enough to accommodate the widest end to be bent, and trued on a shaper to a 45-degree angle on each side. The point should be blunt and hardened, the end in the socket being trued so that it sets perfectly snug when the socket is pulled up right. Fig. 11 shows the finished tool.

This assortment gives a simple and inexpensive provision for doing a wide range of work, especially in shops which have but few pieces to bend at a time; but of course it is good for any number after being set, and so easily changed for any

other angle or size of iron by backing off or running the back-plate up, that it answers for rounds as well as for flats.

A simple device for U-bolts, links, staples, and hangers is shown in detail in Figs. 12, the arms; 13, rollers; 14 studs, and 15, the plunger for U-bolts. The sockets shown in Fig. 10 is used with this device also, and comes in extremely handy for other forms as well, and, like a few dollars in one's pocket, is a handy thing to have.

Flats can be bent as well as rounds by making rollers without concaves. The adjustment for different sizes is made by the eye-bolts on which the rollers turn. Figs. 16 and 17 show the idea. Of course a plunger has to be made for each shape, and it can be made of gray or wrought iron, unless constantly in use. Then the working points should be made of steel if used on cold bending.

Roller arms for the crosshead are the next essential for this machine. There are many shapes bent where the work is done by what are termed "wing" forms, with much better results than from plunger forms. The piece shown in Fig. 18 would tear the iron and reduce the sides so with a plunger form that it would be impracticable, but by substituting the wings the work is done perfectly. Fig. 19 shows a roller-arm for the crosshead. It is made right and left. The same flat rollers, eye-bolts, and threaded rod for adjustment can be used as before. These arms should be forgings, and made quite heavy, as they have sometimes to stand a very heavy strain. At least two $\frac{7}{8}$ -inch bolts should be used to fasten them to the crosshead.

With this outfit on hand a great many cast forms are dispensed with. In some shops these become a positive nuisance, being so numerous, and representing quite a value in useless material.

Tack and Tack-Dies

Although produced by what looks to be the crudest of dies, and which are made and kept in order by the use of the grindstone or emery-wheel alone, the manufacture of tacks is attended with the least waste of material, and the smallest

percentage of bad work, of any business in the sheet-metal line that I know of.

Some years ago I was interested, mechanically, in the

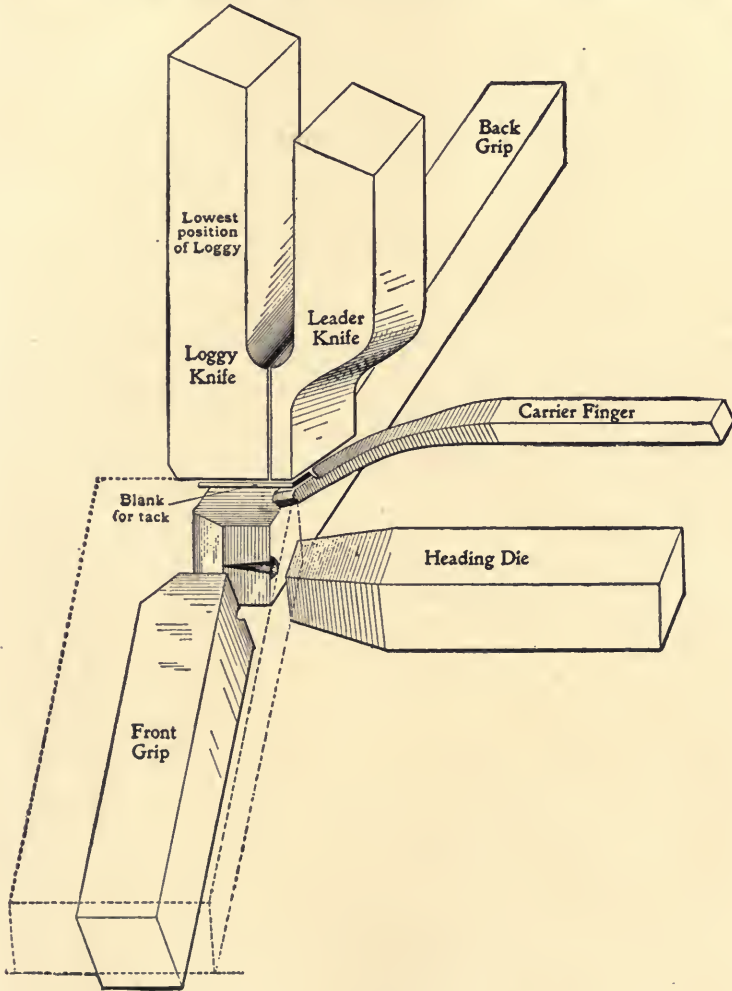

FIG. 233.—Tack-making tools and their action.

making of both tacks and tack-machinery, and while thus engaged I accumulated a lot of information on the subject that may interest my readers.

Tacks were first (I was going to say invented, but I hardly think I could back that claim up) made in the seventeenth century, and in 1775 one Jeremiah Wilkinson, of Cumberland, R. I., started the manufacture of tacks cut from sheet-iron with hand shears and headed with a hand-hammer in a bench vise. In 1786, Ezekiel Reed, of Bridgewater, Mass., invented a machine that would partially make a tack, and in 1798 he took out a patent on a machine for cutting off and heading them in one operation. This machine was fed by hand; but with that exception it was practically the same as the Reed nail machine in use to-day. In 1727, Thomas Blanchard, of

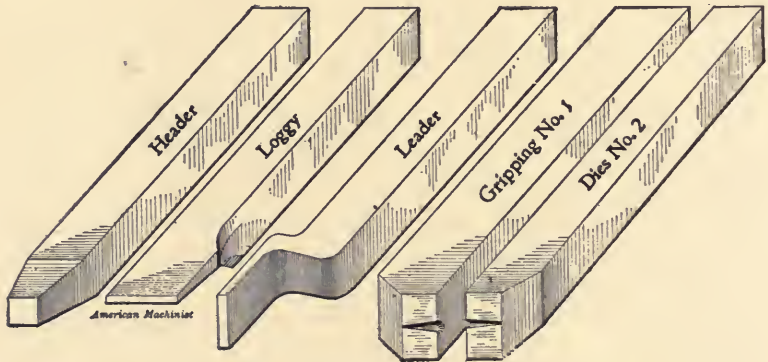

FIG. 234.—Complete set of tack-making tools.

Abington, Mass., invented a machine intended especially for tacks. This machine is what is known to this day as the Blanchard tack-machine, and is the only successful machine in use for cutting tacks from sheet-metal that I am acquainted with. As first made, it was a hand-fed machine, whereas now it is automatic; but with that exception the machine was precisely the same as built to-day. The tack is cut off by the contact of the two upper knives (see Figs. 233 and 234) and the bed knife below. In the action of cutting, the two upper knives work as one; and as soon as the blank for the tack is cut off, and the left-hand knife, known as the "loggy," stops, and the right hand one, called the "leader," holding the blank by

the aid of a bent finger of steel, called the "carrier," carries it down into the gripping-dies, which close and hold it while the heading-tool comes up, upsetting the stock which has been left projecting out from the dies for the head; and, as the dies open, a knock-out attachment clears the tack from them, and it falls into the pan below. These operations, five in number on each tack, are performed at the rate of 275 tacks per minute, and for nearly 600 minutes in a day. One tacker and a good boy will grind, keep the dies in order, and operate eight to twelve machines.

The die-making outfit consists of a single machine, a double ended emery-grinder—one end carrying a large, coarse wheel for roughing out the dies, and on the other, two or more thin wheels for "scoring in" the gripping dies and making the counter-sink seen under the head of the tack. Very little forging is done on the dies. The heading-die is drawn down to about $\frac{3}{8}$ of an inch square, so that it will not strike the "leader" knife, and the "loggy" is drawn down thin so as to avoid the gripping-dies.

There is one thing about the machine I think remarkable, and that is, the test of time the invention has stood; it has been in use over one hundred and eighty years, with little or no improvement, except on the feed motion. As originally made, it could be built with a very few tools, no planer work being necessary and very little lathe work, the shaft being of cast iron with the cams cast on; and I never listen to the music of their running (for it is music for me) without a feeling of admiration for the man who invented the machine so far in advance of the age in which he lived.

A Rapid Action Hydraulic Forging Press

As most well-informed machinists are aware, there has taken place in the past ten or fifteen years a radical change in the methods employed in forging heavy work. This change has been, briefly, the substitution of the press for the hammer. With the increase in the size of forgings and in the hardness of the material of which they are made, there has come in-

creasing difficulty in obtaining satisfactory results with the steam-hammer. With the most powerful of these machines in use fifteen years ago, it was well nigh impossible to deliver a blow to such intensity that its effects would reach to the center of an ingot of the large size required for the heaviest marine and ordnance of the period. A blow of ordinary intensity would merely deform the surface of the work; flaws in the center of the material might even be enlarged rather than obliterated. The increasing size of hammer necessary to produce the desired effect in forging reached its culmination in the great 125-ton machine, of which a model was exhibited by the Bethlehem Steel Company, at the Chicago Exhibition. This great instrument, however, had scarcely commenced what was expected to be a long life of usefulness before the process of hydraulic forging was found to be so far superior to hammering that the giant machine was relegated to an inglorious obscurity.

Tremendous Pressure of the Hydraulic Press

The hydraulic forging-press was first applied only to extremely heavy work. On billets and forgings of large diameter, the steady and tremendous pressure obtained from it is distributed through the whole mass of metal clear to the center, bulging out the side of the work instead of merely making an impression on the surface which can come in contact with the dies. This action works the metal throughout its entire volume, closes up all the flaws, and gives to every fiber the toughening effect produced by judicious working. But the slowness of action of the regular hydraulic press limited its use to large work in which considerable time was of necessity consumed in handling the parts being operated on and bringing it into position for a new stroke.

To obtain, on medium-sized work, the benefits of pressure-working as distinguished from impact-working, a number of arrangements have been devised for giving a high speed to the ram in raising it from the work and lowering it again, with provision exerting the desired heavy pressure as soon as the

parts are in contact with the forging. Of these various arrangements one of the most interesting is that employed by Davy Bros., of Sheffield, England. Applications of the idea to two forms of forging-presses are shown in Figs. 235 and 236. The various parts are seen in Fig. 235, and the line drawing of the same press in Fig. 236. The upper die *A*, is attached to a crosshead *B*, which has bearings on the four vertical tie-rods. The hydraulic pressure is applied to cylinder *C*. *D* and *D*

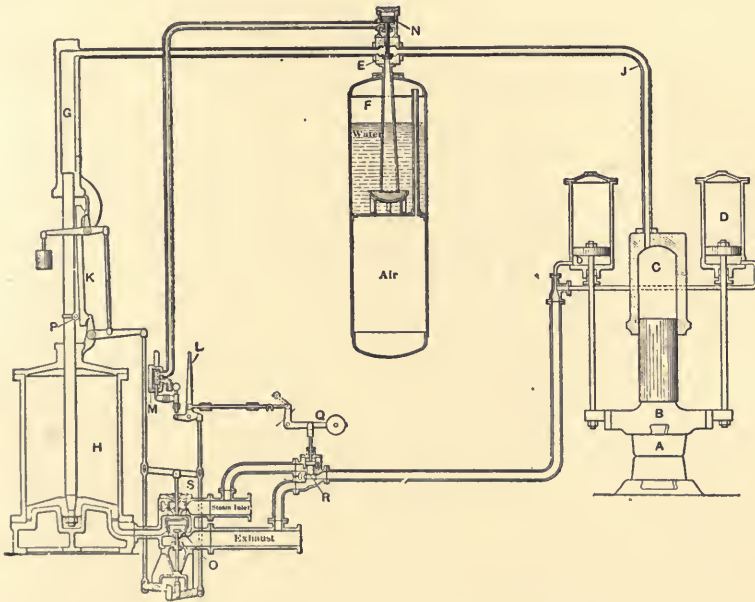

FIG. 235.—Rapid action hydraulic forging press.

are two steam-lifting cylinders for raising the ram. *F* is a combined air and water vessel, adapted to store the water used in the hydraulic operations and furnish it to the ram as desired for the quick movements, this being done by displacement due to a moderate air-pressure. These operations are controlled by an automatic valve at *E*. *G* is the hydraulic cylinder of the steam intensifier, whose steam-cylinder is seen at *H* in Fig. 235, the main part of it being below the floor.

Operation of Process

The operation of the mechanism can perhaps best be described by following the movements of the operator in making a single working-stroke on a forging, starting with the ram in the position shown in Fig. 235, with the dies together. The movements of the press are controlled by lever *L*. The operator first desires to raise the ram *B* for the purpose of inserting the work. Handle *L* is pulled over toward the right, this opens

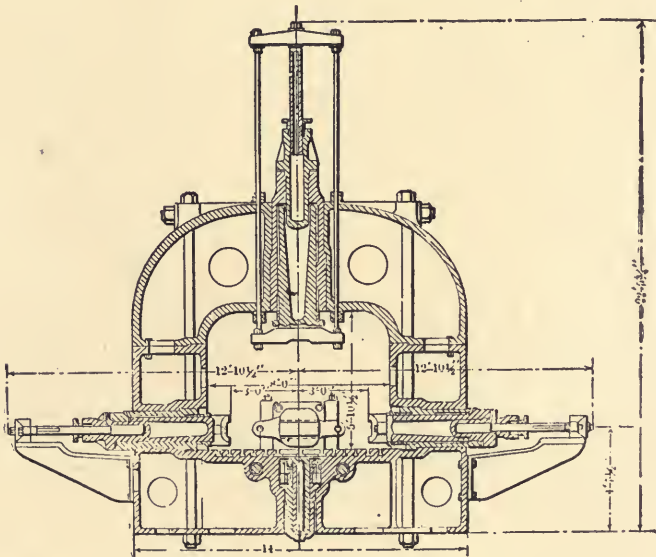

FIG. 236.—Rapid action hydraulic forging press.

valve *R*, first allowing the stem to enter under the pistons in lifting the cylinders *D*. Ram *B* is thus raised, forcing the water contained in cylinder *C* back through pipe *J* into the water end of the intensifier at *G*. When the intensifier ram has been forced downward and the space above it has been completely filled with the returning water, the upward movement of ram *B* would have to cease, did not the operator continue to pull lever *L* farther toward the right. This action operates a relay valve at *M*, which, admitting steam

under an auxiliary piston *N*, opens valve *E*, thus allowing the water in pipe *J* to escape into the water-space of reservoir *F*. This reservoir has a lower compartment containing air under moderate pressure, but the steam in the cylinder furnishes sufficient force to return the water to the reservoir against the air-pressure contained in it. The ram being thus raised for the insertion of the work, the operator returns lever *L* to its central position, when all valves are closed and the parts are in equilibrium.

The work being properly presented to the dies, the operator pushes the controlling lever toward the left. This movement first shifts piston valve *R* and connects cylinder *D* with the exhaust. The weight of the ram and die is thus left unsupported, and they descend at the rate of about 2 feet per second, being helped along by the water under pressure in reservoir *F*, entering through valve *E*, which is arranged as a check-valve and freely permits movement in this direction. As the die reaches the work, a further movement of handle *L* to the right, through the connecting mechanism shown, opens the balanced poppet valve *S S*, admitting steam to the under side of the piston in the steam-cylinder *H* of the intensifier. The upward movement of the ram resulting from this forces the water under tremendous pressure into cylinder *C* of the press, giving the movement and pressure required for the working of the metal.

This movement is under strict control, the length of the stroke of the intensifier piston being limited by the amount by which lever *L* has been pushed over toward the left. This governing action is obtained through a floating lever mechanism, similar to that used for water-wheel governors, steering engines, etc. A bar, *K*, set on an angle is engaged by a roller *P* attached to the intensifier piston-rod. The pushing of lever *L* to the left moves bar *K* toward the roll. As the roll travels up *K* it pushes it back again, and the pushing back of this bar is transmitted through the floating lever to inlet valve *S* and exhaust valve *O*, operating them in such a fashion as to stop the movement of the intensifier at the desired point.

Provision is made for short rapid strokes under full pressure, for such work as rounding, swageing, cogging down, etc. By means of a lever shown in Fig. 235 at the operator's left hand, the connection between lever *L* and valve *R* may be severed. This condition is shown in Fig. 235 by the dotted lines, showing the link attached to the bell cranks raised. Weight *Q*, under these conditions, drops valve *R*, keeping the lifting cylinders in constant communication with the steam-pressure. Now the handle *L*, being worked back and forth from left hand to the central position, steam is alternately forcing the ram down and allowing the steam-pressure at *D* to bring it back. Under these circumstances, the water under pressure in reservoir *F* is not used at all, since handle *L* is not moved to the right far enough to separate relay valve *M*. This rapid action brings the press into the same class with the steam-hammer for operations of the kind referred to.

Pressure for Small Work

For smaller work, that requiring a pressure of from 150 to 300 tons, the single column type of machine, illustrated in Fig. 237, is used. In this the whole mechanism is self-contained, as shown, the intensifier being mounted at the rear of the frame, which is hollow and serves as a reservoir for the water-supply under pressure. The method of operation and the principle of the mechanism are, however, identical with that of the larger presses. The 150 and 200 ton machines will work 6 and 8 inch diameter ingots successfully. For the large sizes, with the ordinary steam-pressure of 150 pounds per square inch, and water-pressure of $2\frac{1}{2}$ tons per square inch, the size of ingots which can be worked varies from 10 inches for the 300-ton size and 36 inches for the 1,500-ton size, to 72 inches for the 4,000-ton size. The smallest of these machines, working on short stroke, will make 80 strokes per minute with the reservoir *F* cut out and steam-pressure on the raising cylinders as described; and with a machine as large as 1,200 tons, as many as 60 effective strokes per minute may be obtained. This great rapidity of action

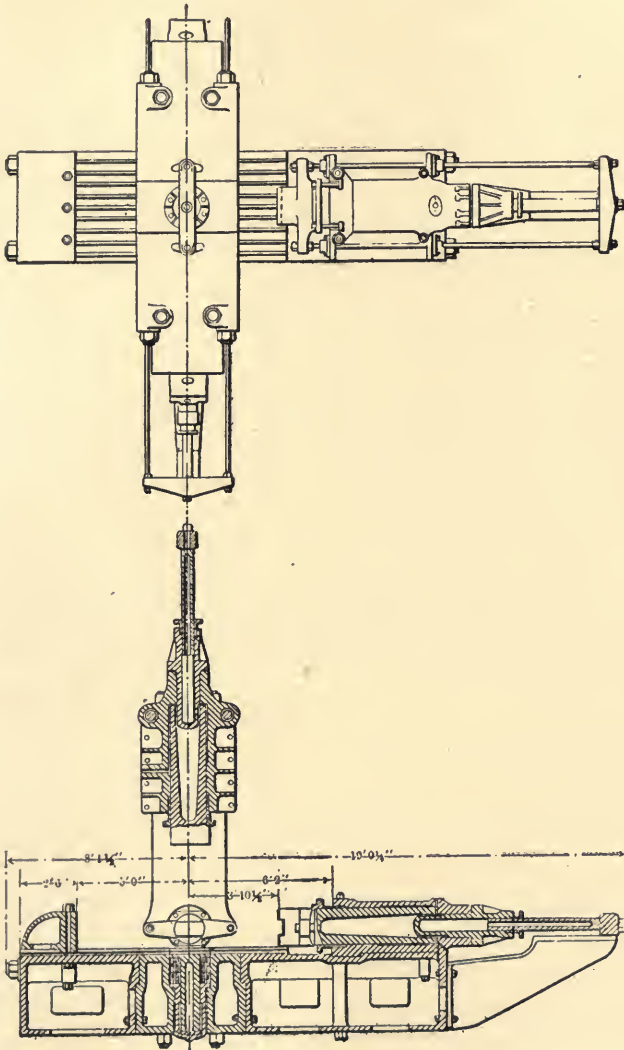

FIG. 237.—Multicylinder hydraulic forging machine.

brings the hydraulic-press well within the field of the small and medium sized steam-hammer. Such presses are somewhat more expensive than hammers of equivalent power, but the additional cost of the foundations for the latter approximately counterbalance this condition, so that the first cost is really about equal. Only about half the steam is required for the press, and it is much less liable to waste through wear and neglect. It has also the great advantages that the breakage of the working parts is very small, and the tools can be made lighter and cheaper, and last longer.

Hot-Pressed Nut-Machine

The line engravings, Fig. 238, herewith illustrate the Burdick hot-pressed nut-machine built by the Howard Iron Works, of Buffalo, N. Y. This machine is of heavy design, as indicated in the illustration, and will form from the bar hexagon or square nuts of any size from $\frac{5}{8}$ to $1\frac{1}{4}$ inches.

Referring to Fig. 238, which gives a clear idea of the construction and operation of the machine, it will be seen that the slide *AA'*, which carries the cut-off for severing the stock, is actuated by a cam *B*, which is mounted on the driving-shaft, together with four eccentrics *C* and two fly-wheels; the connection between the two portions of the cut-off slide are adjustable for wear by means of jam nuts, so that backlash is avoided and smooth running assured. The cut-off *D* is held in a holder *E* by a set screw *E'*, and the holder is turned bolted to the side that it can be adjusted to a limited extent.

The four eccentrics are in two pairs for operating the slides *F* and *G*, which carry, respectively, the crowner and piercer; the slides and eccentrics being connected by eight rods *H*, four on each side of the machine. The piercer is held in its slide by a very strong friction-clamp *I*, and is readily removed. The piercer slide connections are rigid, the wear being taken up on the eccentric straps.

The crowner *J* is held in its slide by clamp bolts, and the connections on this slide are so arranged that when the nut is being pressed into shape the pressure comes on a very heavy

abutment *K*, and does not strain the eccentrics and operate the slide. The four rods connecting the eccentrics and the slide pass freely through the trunnion connections *L*, and each of the rods is provided with a spring *M*, which is confined, as shown, between the end of the connection *L* and the collar clamped to the rod. When the slide reaches the abutment,

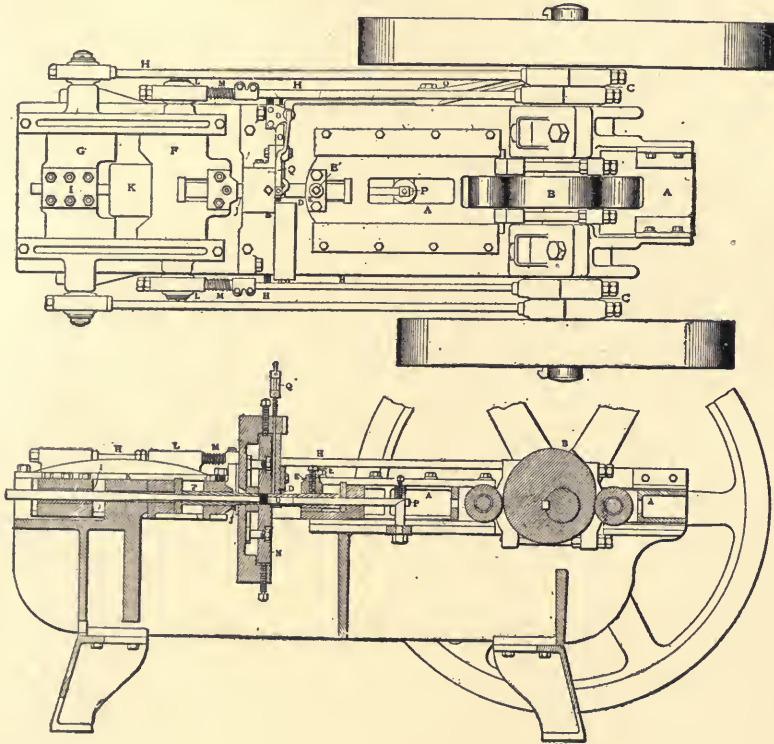

FIG. 238.—Hot-pressed nut machine.

the rods slide on a certain distance, leaving the stationary long enough for the nut to be pressed or crowned, the springs *M* on the rods taking up the slack on the return stroke without noise or shock.

In operating this machine, the heated stock is fed in front of the forming-dies *N* against a back gage *O* (and also against a back gage which does not show), and the cut-off advancing

cuts off and forces the stock for the nut into the dies, bringing it up to the crowner (which is stationary for the time being) and pressing it into shape. While the partly finished nut is held rigidly between the crowner and cut-off, the piercer advances and completes the nut. As soon as the hole is pierced, the cut-off, which is held stationary during the piercing operation, moves back and the crowner follows it up, but at a slower pace, so that when the cut-off arrives at the end of its stroke and the waste or scrap is ejected by means of the stationary rod *P* the nut is shoved outside of the forming-dies by the crowner and drops under the machine. Should the nut have any tendency to stick, it is removed by a knock-off *Q*, which is operated by a cam on the main shaft; thus it is impossible for two nuts to get into the forming-dies at the same time under any conditions.

This machine can be changed from one size of nut to another very quickly, as only the tools require changing, the movement of the various members of the machine being the same for the different sizes of nuts.

The speed of the machine depends somewhat on the expertness of the operator, a speed of about 80 turns per minute usually giving good results. The makers state that the output is from 15,000 to 28,000 nuts per day of ten hours.

The machine is very rigid, and weighs, when ready for work, 9,000 pounds. It has fly-wheels 48 x 7 and 60 x 7 inches, and may be belted direct from a clutch on the line-shaft.

A smaller machine is built on similar lines for $\frac{1}{4}$ to $\frac{5}{8}$ inch nuts. This runs at 110 to 125 turns per minute, has fly-wheels 30 x 6 and 36 x 6 inches, and weighs 4,100 pounds.

A Large Hydraulic Forging Machine

In order to reduce the cost of certain smith-shop work done by the Pennsylvania Railroad, the multicylinder hydraulic forging and upsetting machine, shown in Fig. 237, was designed and built.

The machine has been in operation over a year and has more than met the expectations of those responsible for its

installation, as the average price paid for 32 operations now being done by it is only 21 per cent. of what these same operations cost when they were performed by hand, and the work is of course more uniform. This saving of 79 per cent. in cost of labor seems almost incredible.

The work for which dies have so far been prepared is the usual run of locomotive forgings. A few of these are shown at Figs. 239 and 240, and beneath each cut is the percentage of saving over hand methods. The dies are very simple and low-priced, and the cuts of the work are shown more to call attention to the saving in cost than to show anything extraordinary about the shapes produced.

The press consists of a bed-plate and housings supporting five cylinders; two side rams, principally used for holding the dies and gripping the work when upsetting; a horizontal ram for upsetting and forming; a vertical ram for punching and shearing, also for forming parts that are more easily handled in a horizontal position. Underneath the bed, in a line with the vertical cylinder, is a stripping ram.

The capacity of the vertical and horizontal rams, each, is 200 tons; the two side rams 150 tons each, and the stripping ram 50 tons. All cylinders are steel-castings.

The bed-plate is in three sections, the housings in four. They are held together by steel rods, shrunk in place. The cylinders are all made separate from the bed and housings, to allow for their easy removal.

The machine is controlled by one man, from a platform, where a full view can be had of any operation. The water-pressure used is 1,500 pounds per square inch.

A special overhead traveling crane serves the press, taking the iron out of the furnace, placing it in position, and removing the finished pieces.

Making Elevator Buckets with the Steam-Hammer

Some years ago I had occasion to make about fifty elevator buckets for a dredge. The buckets, which resemble Fig. 241, had formerly been hammered to shape by hand in a cast-iron

former, with mallets. This was a tedious and expensive process, requiring a number of heatings for each bucket, and as more of them would probably be needed for future dredges we decided to make a pair of cast-iron dies and form the buckets in a single operation with the 3,500 pound steam-hammer.

We had on hand a sample bucket of $\frac{1}{4}$ -inch steel, and as the small reductions in size by shrinkage of the die-castings were not objectionable, I used the sample bucket as a pattern from which to mold the curved portion of the two dies. A cheap wooden frame *A*, Fig. 242, was nailed up for a pattern for the body of the female die, the sample bucket *B* was set in it and fastened with wood screws, *S S*, and his wood and iron pattern was blocked up in the drag. Sand was then rammed

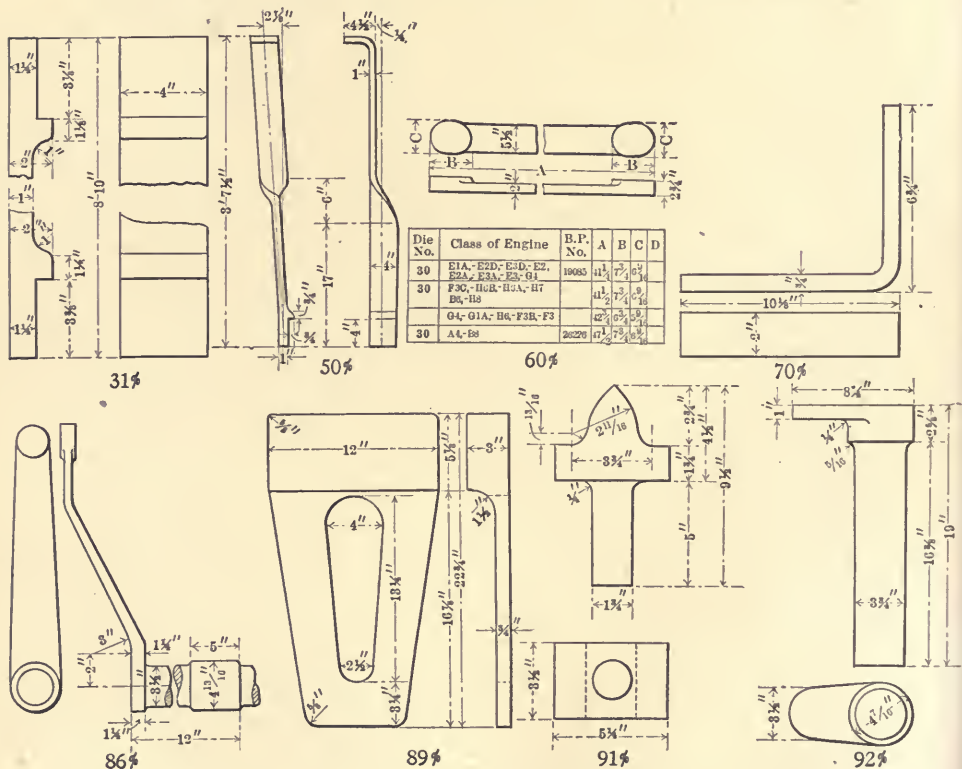

FIG. 239.—Locomotive forgings made in hydraulic machine.

in the drag around the side and inside of the pattern. The dovetail strips, *Q*, were then set, the parting made and the cope rammed up, the mold now appearing in section like Fig. 240. It was then rolled over, the blocks removed, the bucket *B* unscrewed and lifted out of the frame. Parting sand was then put on the curved surface left by the bracket, and the drag was rammed up against this sand pattern. The drag was lifted and turned, the wood and sand pattern removed from the cope, and the mold closed, appearing in section like Fig. 243. The male die was molded in a similar manner, and as shown in Figs. 244 and 245.

The molding was done with care, and the resulting casting was excellent. The male-die was planed to fit the hammer-

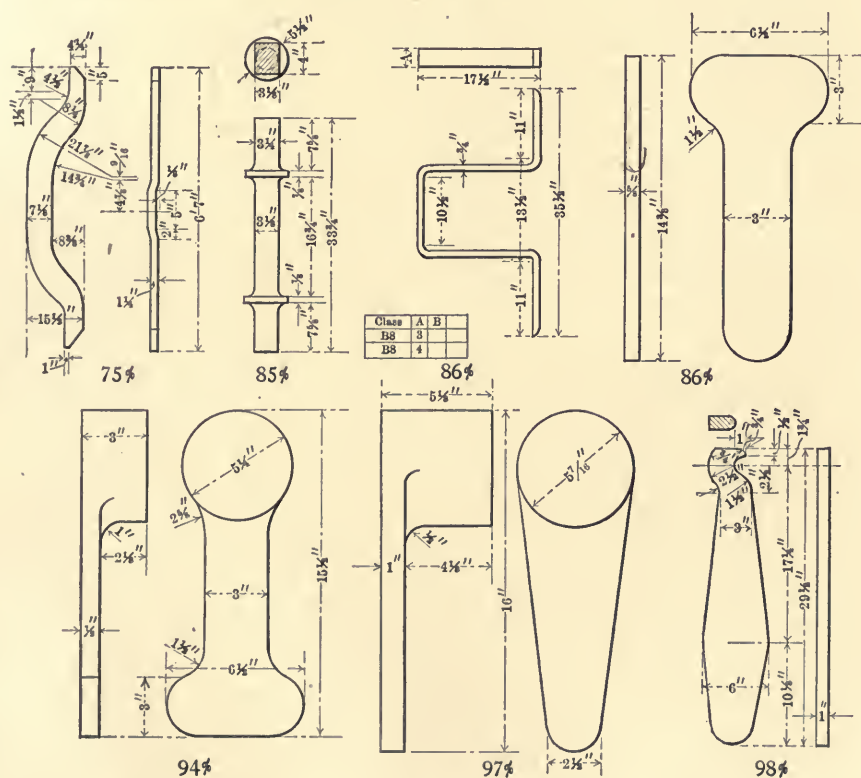

FIG. 240.—Locomotive forgings made in hydraulic machine.

head, and the female to fit the anvil-block. Two 1-inch guide-pins, with their outer ends well tapered, were driven tightly into the lower surface of the male die. The plates for the buckets were cut to very nearly the correct shape, and two holes, *E*, Fig. 241, were punched for the guide-pins. After heating in the furnace, the plate was held up on the guide-pins while the hammer was brought carefully down, not striking any blow until the plate was forced nearly to shape. This gave the helpers time to take their tongs away after the plate touched the upper edge of the lower die. One or two blows then took out any wrinkles and formed the buckets nicely. The entire lot of buckets were formed easily in one afternoon,

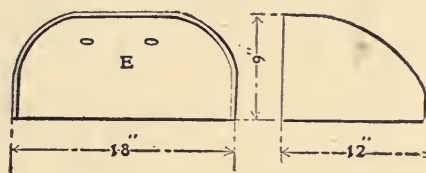

FIG. 241.—Design of elevator bucket.

their shape was more uniform than that of the hand-made buckets, and the labor saved on this one lot more than paid for the dies.

A Job for the Heavy Swaging-Machine

The finished forging, Fig. 246, shows what can be done on a heavy swaging-machine similar to the Armstrong-Whitworth type, and a description of how it is done and the swages used may be of interest.

This machine has four rams, making about 600 blows of 1-inch stroke per minute. It has also four lower rams which are adjustable to suit the particular job, and they can also be moved when required while operating in forging. The diameter and length required are determined by trial. It is easier to make two heads than one at the same time, as all the forces are balanced, and hence there is no jerking of the forgings as would happen when making one; for this reason, as well as the

manufacturing one, the stock is cut off long enough to make two complete forgings. The stock is heated, preferably in a gas or an oil furnace, and rotated along the cutters, dividing it into two equal lengths, as seen in Fig. 2, when it is transferred to the heading swages, Fig. 3. The groove formed by the cutters is run on the sharp edge of the lower swage and then is rotated along from right to left until it comes out at

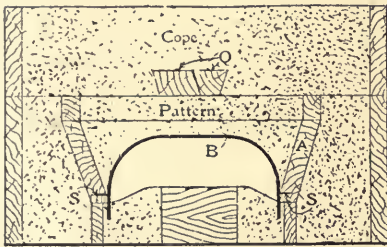

242

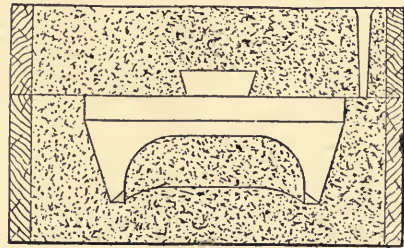

243

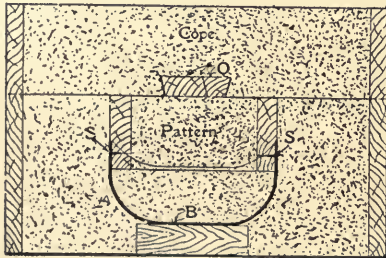

244

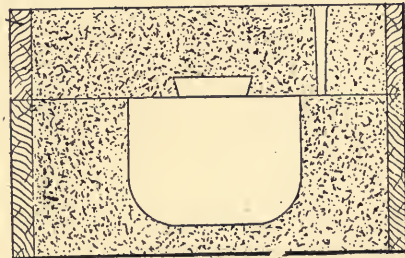

245

FIGS. 242 to 245.—Molding elevator bucket dies.

the other end, producing two well-formed heads, as shown in Fig. 4.

The $1\frac{1}{2}$ -inch diameter stock gives about the right amount of material which the swages can take in to form the ball. To use a larger diameter of stock is to have a poorly formed head, which will be anything but spherical and will take a longer time to swage.

The end of the stock is next drawn out in the reducing swages, Fig. 5, then flattened down to the required breadth

and width on the other end of the same swages by alternately passing it through first one way and then the other, as can readily be seen. All of these operations are rapidly performed, the forgings being then separated, and this finishes the first heat.

The second heat consists in forming the V-shaped part, Fig. 6, intended to fit over an inch-square bar, and in making

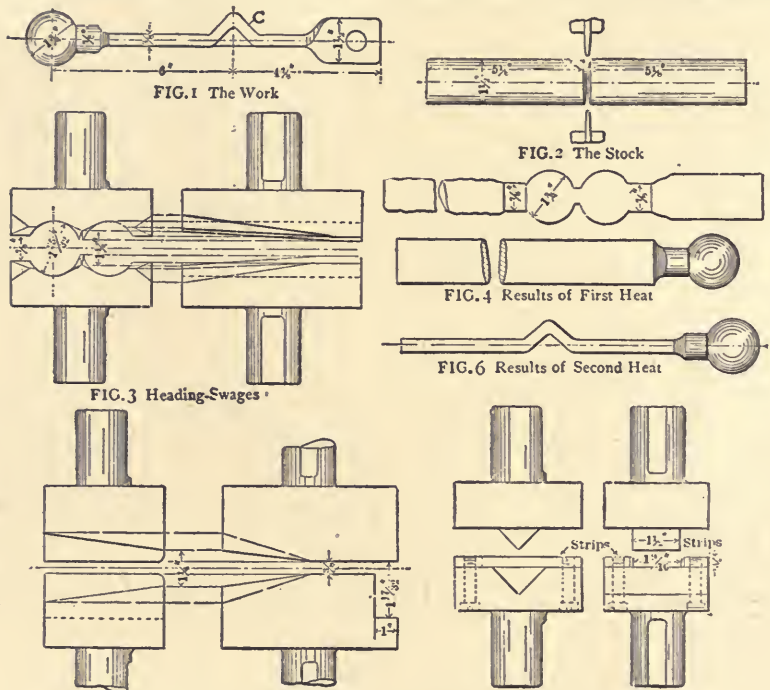

FIG. 246. —Forging in the heavy swaging machine.

the quarter twist, both as seen in the finished forging, Fig. 1. The forming swages illustrate how the V is set in, the swages being shown in the open position. The forgings are located between the strips, and the lower ram is moved up quickly while the blow from the upper ram bends the forging into the shape shown, the strips, which are of the same thickness as the forgings, acting as stops.

The quarter twist is made by a fixture which consists of

two main parts, the holder, and the key, the construction of both being chiefly shown. The face on the forging is brought up to the face of the holder; the key is moved along the pin on which it rests, as shown in the elevation and which also keeps it central with the socket in the holder.

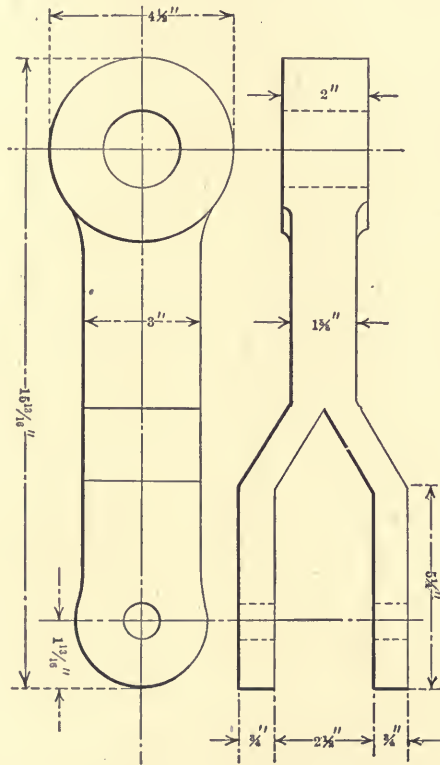

FIG. 247.—Passenger-car truck swing hanger.

The lever which operates the gripping plate by means of an eccentric pin is then raised, after which the key is rotated until the handle strikes the stop, twisting the forging with it to the required angle. The forging is removed by slipping the key back on to the pin and then pushing the lever back to the open position.

In a fixture which is likely to become hot by contact with

the material operated upon and where scale gathers, gripping screws are objectionable owing to the difficulty of retaining the gripping plate such as *F* in place and also on account of lubrication. The reason for using the eccentric pin, which is quick in its action and self-locking, is mainly to overcome this trouble, and it is a good construction. In order to get rid of

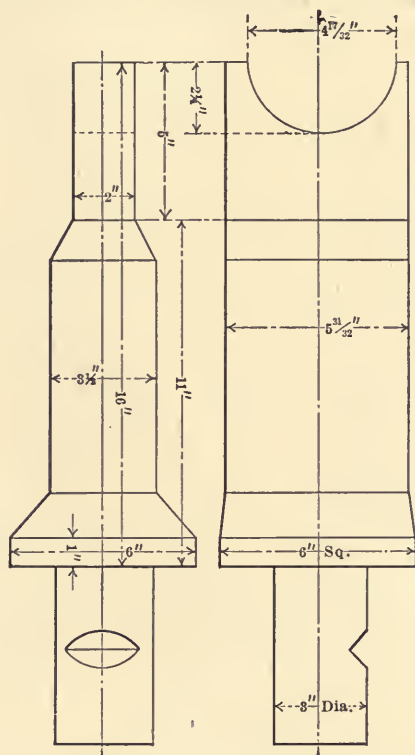

FIG. 248.—Bolster for postal and baggage cars.

the scale which will naturally gather in the holder socket, a slot is cut into which all the scale will drop, keeping the socket clean for the key to operate in.

These tools are forged from steel, except the quarter-twist fixture, the holder being a gray-iron casting. All are carefully made, the swages requiring special care in machining, as will be apparent. The swages are arranged in the rams, so that the

operator passes from one to the other consecutively; first, to the cutters, second, the heading swages, third, the reducing and flattening swages, and fourth, the V-forming swages, the quarter-twist fixture being conveniently located at the end of the machine. Adjustable gages are also fixed to the machine and locate all the positions while forging that are necessary.

This forging furnished a good example of some of the many operations which can be performed on a heavy swaging-machine. The operator of such a machine need not be a smith, in fact my practise is not to have a smith, but a good smith's helper, who can be more readily taught, and such work is also a step in the right direction for him. This machine takes care of a class of work which is often done on the drop-stamp and produces a forging which is accurate, next has no fin, and hence leads to little loss in scrap at a price ranging from $\frac{1}{2}$ to 1 cent per pound.

Drop-Forging for the Ajax Forging-Machine

In a shop where there are orders for a large quantity of car and locomotive forgings coming in daily, the first thing that enters the foreman's mind is how to get the work done quickly, and I find by experience the best way is by the use of the forging-machine and bulldozer.

The large number of forgings that can be turned out by

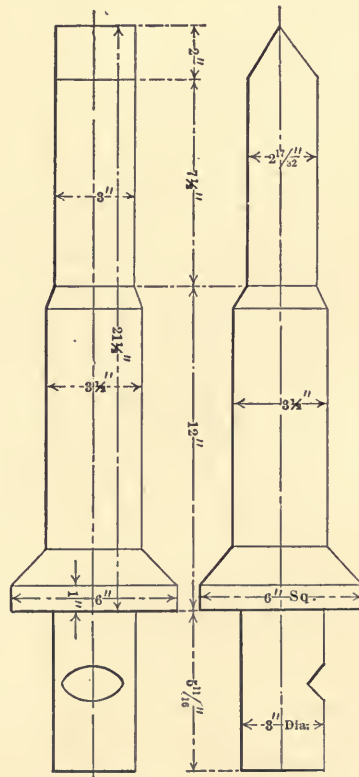

FIG. 249.—Crowbar for locomotive boilers.

these machines daily is surprising, and no well-equipped shop should be without them.

In our 4-inch forging-machine we are turning out the following, as per Figs. 247, 248, and 249: Swing hangers for passenger-car trucks, bolsters for all baggage and postal cars, crown bars for locomotive boilers, drawbar straps for baggage and freight cars, connecting rods for S. L. switch-stands, slide plate switches, and other forgings too numerous to mention, some of which are shown in Figs. 250 and 252.

In designing the dies for the work to be done on these machines, the first thing to do is to figure out the necessary



FIG. 250.—Work of the forming-machine and bulldozer.

amount of stock to make the piece required which will give the length of die to be used. Fig. 252 shows a swing hanger for passenger-car trucks, with the dies and headers for making it. For stock we lay the parts together, put them in a small oil-fired furnace, and in a very short time we have a welding heat about ten inches long on them. They are then placed in the lower space of the dies and the lever is operated. The dies close and the header enters them, the back-stop on the machine holding the stock from slipping back, and in an

instant the two pieces are welded together and the head is formed. The stock is then turned end for end and placed in the upper space of the die, and on operating the lever again the dies close and the taper mandrel enters the die, splits the two pieces of stock apart, and forcing them into the die, completes the hanger, as shown in the lower right hand view of Fig. 252 and also in Fig. 250. We made from fifty to sixty

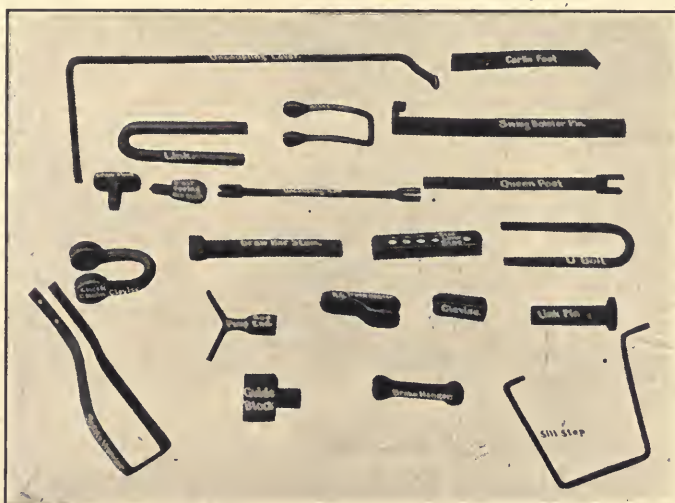

FIG. 251.—Work of the forging-machine and bulldozer.

of these hangers per day, and it does not take long for a machine of this kind to pay for itself.

Care must be taken in setting dies in the machine, and all bolts must be well tightened before starting. Fig. 252 gives all dimensions of the work, the die and the headers. The die seat is 21 inches long when the dies are closed, and the header block is at the end of its stroke. The space between the header block and dies is $4\frac{1}{8}$ inches. When shorter dies are used, the punch or header must be increased in length in the same proportion. As the length of dies is decreased when headers, punches, or mandrels enter the dies, the distance they go into the dies must also be increased.

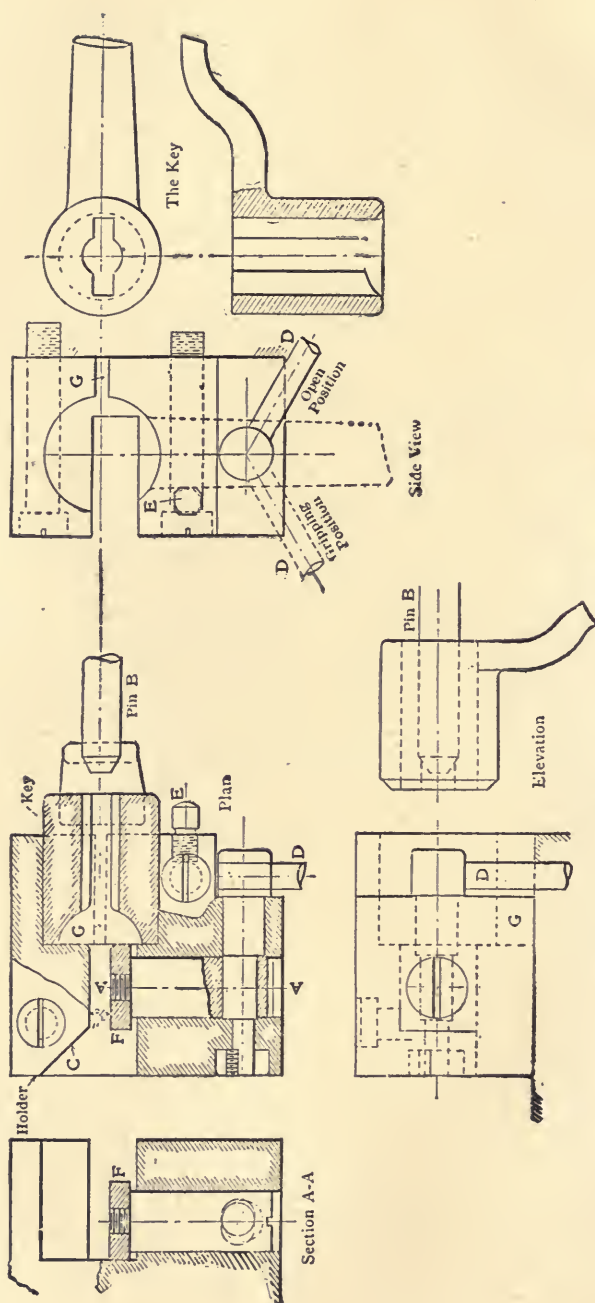

FIG. 252.—Dies and header for forging swing hangers.

In making the bolsters for the tea and silk cars recently built in the Sacramento shops, we take our 1 x 5 x 12-inch bars, cut them off 2 inches longer than the length on the end—which allows one inch on each end of the bar for upsetting and welding—get a nice white heat on the end of the bar, place it in the machine, and press the lever down. The dies close, the header comes up, hits the end of the bar, welds and presses

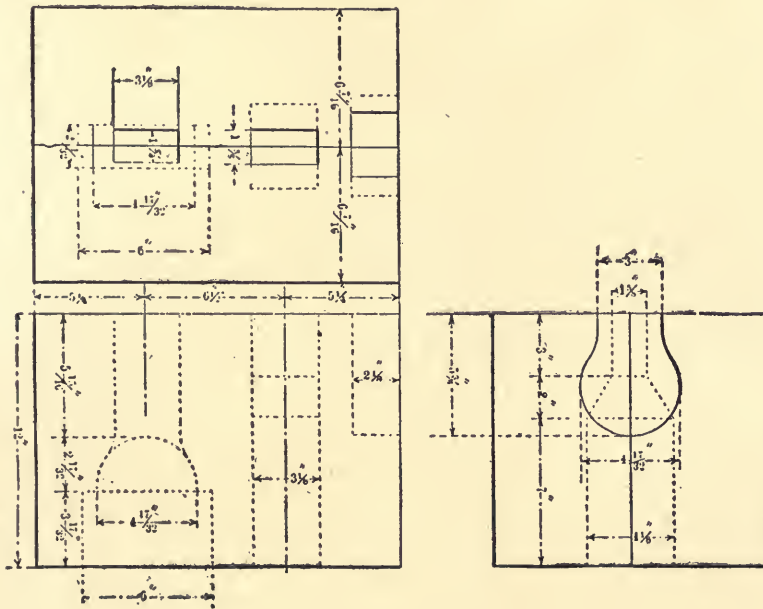

FIG. 253.—Forging machine dies.

it into shape, and we have one end of the bolster completed. Reversing the piece and going through the same operations, we have a bolster completed in quicker time than it takes to explain it. I find by testing this class of work by the steam-hammer process, that it will stand a better test than similar work done by hand. These ends are put on at the rate of twenty to twenty-five per day.

Crown bars for locomotive boilers are made in a similar manner, by laying a piece of $1\frac{1}{8}$ x 3 x 9-inch stock between

two pieces of $\frac{3}{4}$ x 5-inch bars of any length required, the whole being welded and pressed into shape by one operation.

We have a great many target connecting-rods for S. P. switch-stands to make in the Sacramento shops, and this is a

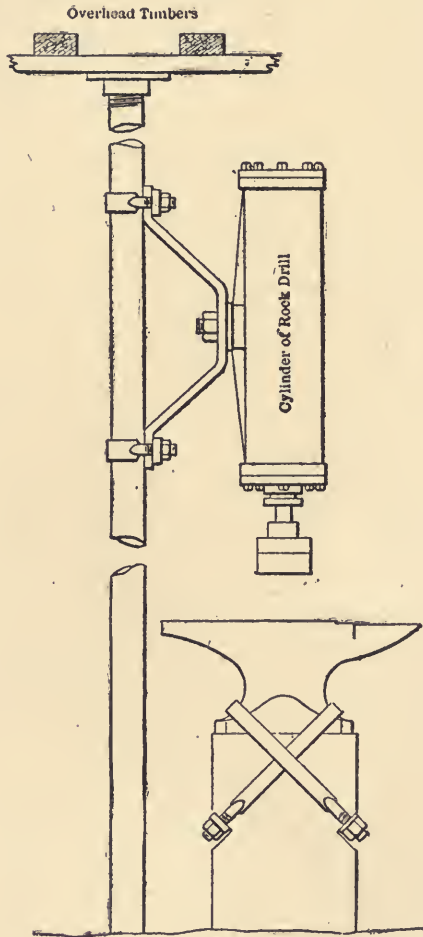

FIG. 254.—An emergency steam-hammer.

simple job for this machine. We take our bar of $1\frac{1}{2}$ -inch round iron on the required length, get a white heat on about 11 or 12 inches of it at one end, place it in the lower portion

of the die, and press the lever. The plunger comes up and upsets an end on the bar $2\frac{1}{8} \times 2 \times 4\frac{1}{2}$ inches long. We then take it out of the lower portion of the die, place it in the upper portion in a vertical position, when the die closes and the punch completes the jaw. We then take the rod to a 3-inch forging-machine that we have close by and upset the other end. This takes but a very short time, and we have a target connecting-rod completed without a weld. The idea in taking these rods from one machine to the other is to save time in changing and setting dies.

The bulldozer, as well as the forging-machine, is a machine that should be in every blacksmith-shop where there is a large quantity of bending and forming to be done, such as draw-bar straps for passenger or freight cars, arch-bars for freight or tender trucks, side sill steps, uncoupling levers, carry irons, corner irons, links and a large quantity of other wrought-iron work that is used on cars and locomotives.

The face of the machine, which is constantly in use in the Sacramento blacksmith-shop, is 14 inches high, 5 feet 4 inches wide, and has two grooves running the width of the face, cut out the same as the grooves in the bed of a planer.

We have two rollers, simply constructed, that we fasten to the face of the machine with the bolts slipped in the grooves. Consequently we can shift these rollers, to bend straps, from $\frac{1}{2}$ inch width of opening up to 5 feet. When any material has to be bent at right angles, we slip one of the rollers on. The plates on the back-stop of the machine is constructed similarly to the face-plate, and we fasten all dies, formers, and mandrels for this. The material is held in the formers or mandrels, before bending, by a hinged clamp made for the purpose. The bulldozer used is a No. 7, and is large enough for all railroad purposes.

A Rock-Drill Used as a Steam-Hammer

The drill, minus the tripod, was fastened to a vertical support about as shown in the sketch, Fig. 254, which was drawn from memory, no attempt being made to show an

exact picture, but merely enough to convey an idea of the arrangement. An ordinary anvil was fixed in a position under the ram, and the necessary air connections, not shown, were made with the cylinder. When a blacksmith has some heavy hammering to do, he has some one, as usual, to manage this contrivance, while the smith takes care to have the blows struck in the proper places as with a steam-hammer, except that the blows are not as heavy, but still more numerous for

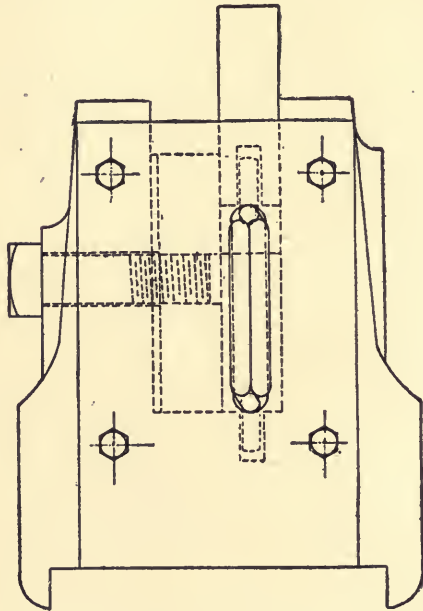

FIG. 255.—Shear for cutting off iron.

a given space of time. At the time I saw this improvised steam (?) hammer in operation, the smith was working down a piece of steel or wrought iron, about 3 inches wide at its widest part, 1 inch thick at its thickest part, $2\frac{1}{2}$ feet long, tapering in both width and thickness, and the hammer appeared to be doing excellent service. It appeared to me as being a very simple, effective, and quite inexpensive apparatus, and that if at any time it be thought convenient to discontinue the use of this rig as a "steam" hammer, it could

be very easily resolved into the original parts and their former duties resumed, since neither drill nor anvil suffers any from this somewhat unusual use.

Shear for Cutting Off Iron

The sketches (Figs. 255, 256) shown here, are of a shear to be used on a steam-hammer. In a shop where there are no shears this will be found to be a very valuable tool for cutting

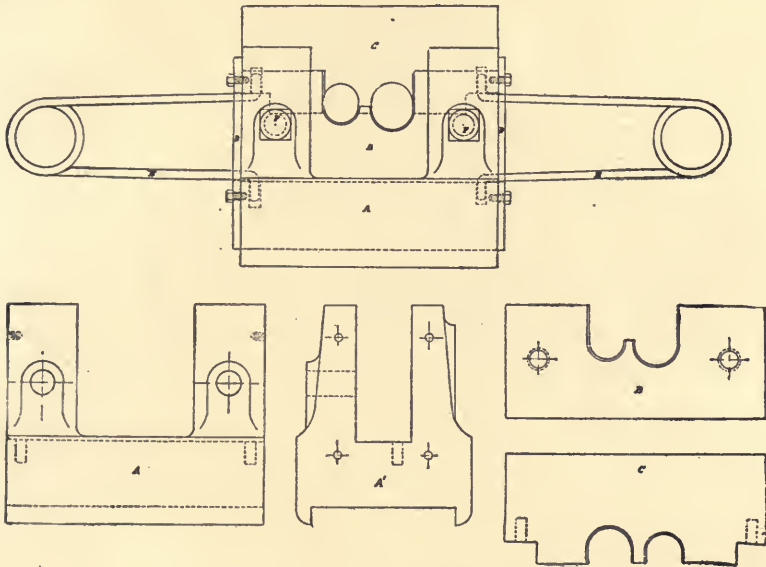

FIG. 256.—Shear for cutting off iron

off iron cold. This sketch represents one of the shears I am using for cutting off iron from $\frac{1}{2}$ to $1\frac{3}{8}$ inches round. I also have one for cutting off two inches round and one for flat iron. I have an 800-pound hammer with which I can cut two-inch round or four by one-inch flat iron with two or three blows.

The upper view in Fig. 256 shows the tool as put together. The lower view shows the details. I have given no sizes, for the reason that it will have to be made to conform with the size of the hammer on which it can be used. *A* is

the base that fits loosely on the bottom-die of the hammer, *A* being a right side view of the piece. It is a steel casting. *B* is the bottom knife, which fits in the base and is held in place with two $\frac{3}{4}$ -inch tap bolts marked *F*. *C* is the top knife, which works loosely between bottom-knife and side of base, and is held in place by a spring on each side, a hole being drilled in the bottom of the knife and in the bottom of base, as per sketch, large enough to receive the bent ends of spring loosely. The knives are made of shear steel. The springs, *E*, are made of $\frac{3}{4}$ -inch round spring steel. The guide-plates for springs on end of base marked *D* are made of $\frac{1}{8}$ or $\frac{1}{4}$ inch tank steel, and are held in place by four $\frac{1}{2}$ -inch tap bolts, as shown. Narrow slots cut in these two plates allow the spring to work up and down. The cutting edges of the knives should be filed back a trifle for clearance to make them cut better.

CHAPTER IX

MACHINE-FORGING, WITH EXAMPLES OF MODERN PRACTISE AND
TOOLS INVOLVED

Machine-Forging

THE progress in machine-forging, or in the use of machinery for forging operations, has been very great in the last thirty years. The greater part of the work for car and locomotive construction now done by machines, such as bolt-headers, bulldozers, steam-hammers and others, was before that done by hand. Those tools that have come into use are the greatest factors in producing forgings for cars. One forging-machine and a good man to run it can produce more forgings than ten fires can turn out in the same time with only one hand at work, and at the same time the work will be more uniform.

You must get up the dies yourself to suit the forgings you wish to produce, as the machine is not of much use without them. It is the same way with a steam-hammer—you can do almost anything if you have the dies and formers to do the job with. In a large shop it will take almost the entire time of a foreman in studying up dies and formers to do certain jobs that come to hand every day. Not only that, but the tools for doing the work one year will be out of date the next, and as time progresses, the engines built one year are not the same as they will be the next; and more so with the cars. They used to be 25,000 pounds capacity, now they are 100,000 pounds capacity. It is the same with engines. You take an engine built twenty years ago and put it beside one that was built to-day and see the difference; and so with all the workmanship done on them, and the tools to produce their heavy forgings. If you have no up-to-date tools, you cannot build

cars or locomotives in a railroad-shop and compete with the manufacturers.

For instance, if all cars had to have Janney couplers on a certain date and your company had a great many cars to equip, and were netting about 2,000 draw-bar stems per month, and you had no bolt-header large enough to make them. To weld a collar on them by hand is out of the question, as with one fire the best you can do is thirty-five or forty per day. You decide to work them under the steam-hammer. To handle the bottom heading tool put up a post by the hammer; the top header, forming the head, a piece of round machine-steel about $4\frac{1}{2}$ inches in diameter and 5 inches long, with the shape of the head carved in the center of it. After you drop your stem, with welding heat, in the bottom tool, you put the top header on the iron (your bottom header will keep the top in the center of the stem), you hit it two blows with the steam-hammer, then turn it over and drive it out the same way, making a perfect head in center of stem. By putting four or five apprentice boys heating them in hollow fires, you can head up 700 stems per day and punch them in the same manner.



FIG. 257.—Engine connecting-rod.

Insert the punch in the top die, and, the motion being so quick, you can punch 4,000 or 5,000 stems before you need to dress your punch.

After getting all these tools up, a change is made in car-building: to use nothing but yokes. Then study again the same as before. The yokes are made out of $\frac{7}{8}$ x 4 inch or 1 x 4 inch, with lips double over the end, for a shoulder, like the sketch. You simply take a round coupling link, weld a handle on one end, put a sharp fuller in place where you want to

make the bend for the hook, and press down with the top die, which will bend it over half-way, then take your link away and hit one blow, which will complete the hook. To bend it on the other end, cast a pocket on your top die, on the front of it; make the bottom out of wrought iron as wide as you want the yoke and as high, and drill in your bottom die and bolt on so as to meet the pocket in top die and lay the yoke. When straight across the bottom former, let the top die come down, which will bend your yoke the required shape. In this manner you can make about 300 yokes a day. This is a good tool, if you have no bulldozer.

Manufacturing Connecting-Rods for Steam-Engines

The connecting-rod is one of the most expensive parts of an engine—the part that is subject to more wear and which requires more repairs than any other. Therefore it should be of the best material and workmanship. The connecting-rods and boxes for the engine under consideration were bought from outside parties, who claimed to manufacture nothing else, and who therefore could sell to engine builders at less cost than they themselves could make them. The rod and boxes complete for a 10 x 12 inch engine cost \$13.50, delivered at the engine works in lots of twenty-five or more.

The body of these rods was rectangular, being about $2\frac{1}{2}$ by $1\frac{1}{8}$ inches at the crank end. They were nicely milled all over and both ends had straps, gib, and key. The boxes were brass, of rather an inferior quality. The workmanship was fairly good, perhaps fully as good as on rods used generally on

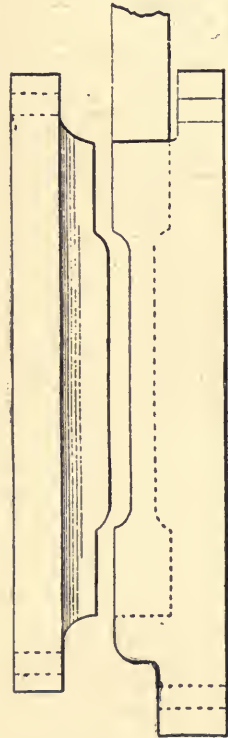

FIG. 258.—Forging dies for connecting-rods.

agricultural engines. The quality as well as the cost, not being satisfactory, it was determined to manufacture the rods at home, and, if possible, to reduce the cost and improve the quality.

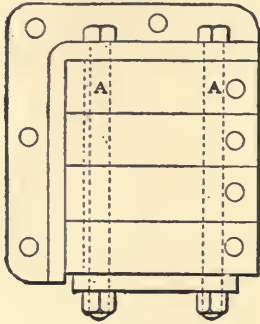

FIG. 259. — Milling the sides of rods.

Fig. 257 shows the design adopted. The body of the rod was smooth-forged, and left unfinished. The boxes were of good grade of brass. The take-up was accomplished by the wedge as shown. In detail the manufacture of the rod was as follows:

The body of the rod was forged from a bar-steel $3\frac{3}{4}$ by $2\frac{5}{8}$ inches under a steam-hammer, and in order to quickly bring the piece to a smooth finish and to uniform size, dies were made as shown by Fig. 258, the sunken die being keyed and bolted to the anvil-block, and the male half to the head of a drop-hammer. The bar of steel being of the proper size for the crank end of the piece without forging that end of the dies was made large enough to receive the bar when hot. The body of the rod and the cross head end was forged slightly smaller than the die the wide way, and slightly larger the other way. After forging, the piece was brought to a bright red heat and placed in the die and the hammer dropped on it, forcing the surplus thickness of metal to fill the die, thus making a smooth piece of work and any surplus being forced out at the bar end. The work was done before cutting off from the original bar, thus avoiding all waste. This piece of forging weighed 32 pounds; the material at that time cost $1\frac{7}{8}$ cents per pound, thus making 60 cents. A blacksmith and helper together receiving \$4.50 per day

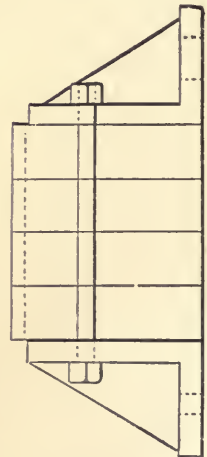

FIG. 260. — Milling the ends of connecting-rods.

forged 20 rods, about $22\frac{1}{2}$ cents per rod. Adding to this 25 per cent. for fuel and repairs, we have a cost of \$1.03 each for this price.

The straps were made of $2\frac{5}{8}$ by $1\frac{1}{8}$ inch steel weighing 28 pounds and costing 52 cents. These were cut from the bar in proper lengths, heated in a heating furnace and bent to

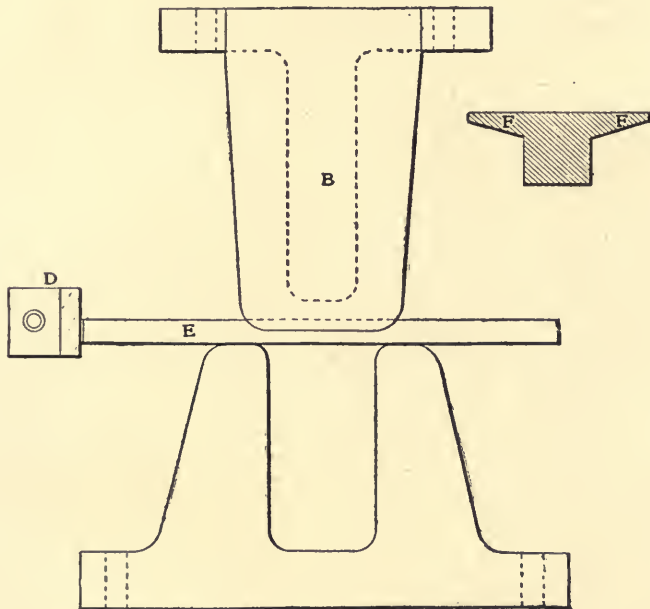

FIG. 261.—Bending the straps.

shape in a bulldozer. When evenly heated they were placed in the die, as shown in Fig. 259, one end resting against the stop *D*. Fig. 259 shows the die and plunger, a section, *F F*, being a guard extending over the plunger to prevent the piece which was being operated upon from getting out of place. One revolution of the machine forced the plunger forward and back again to the starting-point, each revolution bending a strap into shape. Two men using a shear and this machine could cut off, heat, and bend 400 straps

per day of ten hours, costing a little over one cent each in labor. Adding to this an allowance for fuel and dies and the cost of material, we have the two straps completed at a total cost of 61 cents. The method used in bending these straps was to cut off sufficient blanks of various sizes to keep the machine working a day of two at a time. In two days, including changing of dies, sufficient straps could be bent to keep the works supplied for several months.

No doubt there are many readers who never saw or heard of a bulldozer. This machine is now extensively used by builders of agricultural machinery for forming all varieties of shapes. It would not probably pay engine builders to put in this machine unless requiring many forms of bent work, as such a machine would bend from eight to twelve thousand straps per month, if working on them alone.

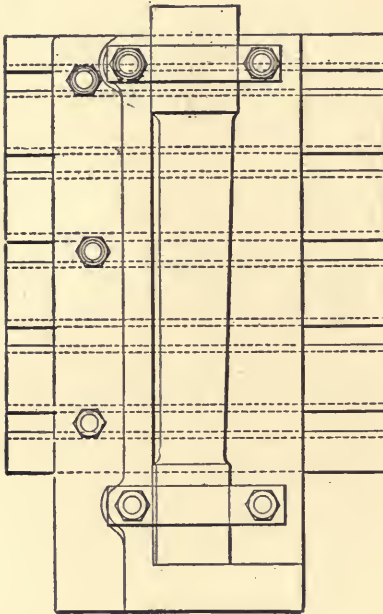

FIG. 262.—Planing the ends of rods.

We now have the forgings complete for a 10 by 12 inch connecting-rod at a cost of \$1.64. The ends of the rods were finished on all four sides in a milling machine, six at one time.

These could be milled complete in two hours at a cost of 40 cents. Adding to this a percentage for keeping up the cutters, etc., we have a cost of 8½ cents per rod.

The next operation was finishing the ends of the rods. This was done in a heavy draw-cut shaper. A chuck (see Fig. 262) being bolted against the head of the shaper and

holding six rods, they could be planed on both ends in $1\frac{1}{2}$ hours, costing in all 30 cents, or 5 cents each. The complete machining of the rod, therefore, cost 13 cents.

The straps were milled on edges, sides, and ends. In order to mill the edges, they were placed in a chuck, the open ends being kept from crushing by a small jack-screw in each strap. In order to mill the sides, they were placed as shown (see Fig. 253), the milled edge being held against the angle plate by bolts *A A*. To mill the ends, two angle plates were used, one of them having slotted holes, as shown in Fig. 254.

After all the outside surfaces were milled they were taken to the shaper where the inside surfaces were finished. The shaper used in this work was a heavy drawcut machine—that is, one in which the cutting is done while the ram is moving inward. The cross-rail had an up-and-down feed. A chuck (Fig. 257) was placed on top of the sliding-head with surface *E E* resting against the housing of the machine. Cutter-

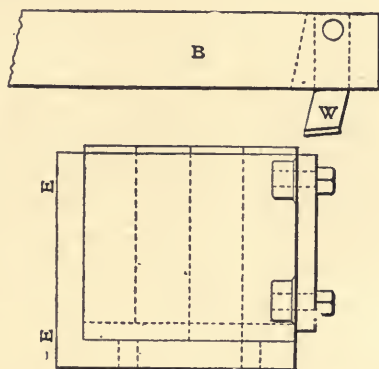

FIG. 263.—Machining inside surface of rods.

bar *B* was attached to the ram, the roughing cutter *W* cutting at both ends, the lip removing part of the stock at the end of the strap. The finishing cut was made with a double-end cutter of exactly the width required, which also cut away the remaining stock at the end. The milling and shaper work was done with a liberal supply of oil. Six sets of straps were milled on all the outside surfaces in six hours. The shaper work required three hours. The total cost in labor was \$1.80, about 30 cents per set.

The adjusting wedges were made from a bar of cold rolled steel of the proper size. This was placed in a jig and milled off on one side to the proper angle and cut to length with a

slitting saw. These were made in large lots at a labor cost of 3 cents each.

The brass boxes for each end were cast in one piece. The weight of these per set was 8 pounds. Brass casting at that time cost 15 cents per pound, making the cost per set \$1.20. They were bored and faced in a turret lathe, then placed in a jig in a double spindle milling-machine, and milled on all four sides to fit the straps. They were afterward cut in two with a sliding saw. These boxes were machined in lots of from 50 to 100, the labor cost being 20 cents per set.

Each connecting-rod required four bolts for bolting the straps to the body of the rod, and two bolts for the adjusting wedges. These were made in a turret-machine from hexagon stock, costing in labor 25 cents and in material 17 cents. Jigs were made for drilling the straps, the body of the rod and the adjusting wedges. Drilling these cost 30 cents.

The assembling of the various parts was done by the piece, for which 75 cents per rod was paid. This work included smoothing up the sharp corners, tapping the holes in the wedges, and fitting the boxes to the straps. The various items of cost were:

Forgings, including material for the adjusting wedges . . .	\$1.69
Machining rod body13
Machining straps30
Machining wedges03
Brass boxes	1.20
Machining boxes20
Material for bolts25
Making bolts17
Drilling30
Assembling75
	<u>\$5.02</u>

Adding 25 per cent. for the shop expense we have total cost \$6.27.

In this chapter I have described the tools and methods used in the manufacture of some parts of a 10 by 12 inch

engine, by means of which the plant was brought up from a non-paying condition to a very profitable one.

The smaller parts, of which there has been no mention made, were all machined in the usual way, the work on them being done by the piece.

Die for Turning Eye-Bolts

The accompanying sketches (Figs. 265, 266) show an eye-bolt bender for the bulldozer or header. We found ourselves in a position where we had to bend about 9,000 $\frac{1}{8}$ -inch eyes of $\frac{5}{8}$ inch stock per season, and the dies shown does the work with an increased output of about 300 per cent.

At *a* is the body of the die, and at *b* and *c* are projections from its face, their inner edges and tops being planed, as was the space between them. A plate *d* bridges over *b* and *c*, and a tool-steel slide *e*, shaped on one end to fit one side of the eye and on the other left straight, except the beveling of one corner as shown, fits the space between *b*, *c*, and *d*. At *f* and *g* are two additional projections, and at *h* is a jaw fitted with a hardened steel face held down with two $\frac{1}{2}$ -inch cap-screws and fitted with two adjusting screws, as shown. The pin *i*, around which the eye is formed, is arranged to be withdrawn during the back-stroke of the bulldozer. It is made of tool-steel and is hardened, as is the bushing in the plate *d*. To turn different sizes of eyes suitable slides, pins, and bushings are made.

The stock is entered at right of the pin *i* to the gage, and the ram *j* enters between the jaw *h* and slide *e* and, of course, forces the latter toward the pin and partly forms the eye, leaving the surplus stock sticking out in a horizontal position,

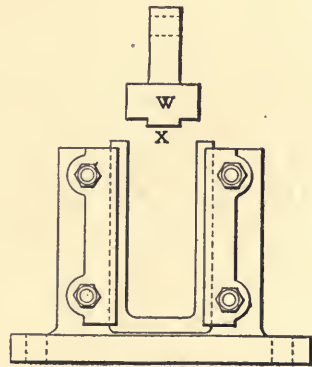

FIG. 264. — Machining inside surface of rods.

when the tool-steel ram *k* completes the turning by engaging with the incline on piece *I*.

About 4,000 1-inch eyes of $\frac{5}{16}$ -inch stock are bent cold per day of nine hours.

Forging with Dies in a Railroad Shop

While in the repair shops of the Lehigh Valley Railroad Company, at South Easton, some interesting methods and

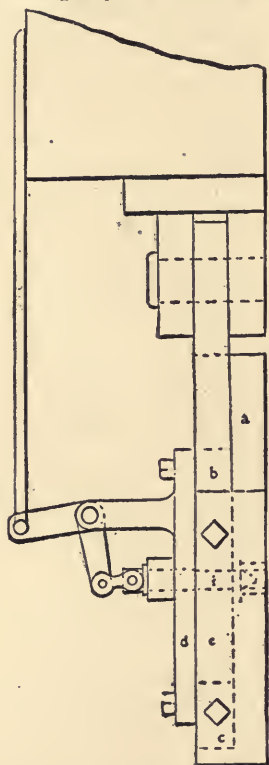

FIG. 265.—Bending eye-bolts in bulldozer.

tools were observed, which, as time-savers, deserve to be noticed here.

In a blacksmith-shop a 200-pound Bradly hammer was kept in constant use, dies of different forms being employed on a variety of work. These dies were not of expensive drop-die order steel, profiled to shape and hardened—but were plain cast-iron blocks, with the desired shape cast in their faces.

One pair of dies were doing some very creditable work forging straight peen-hammers, of which several hundred per year are used around the shops and on the engines of this road. The stock for these were an inch and a quarter, and cut long enough for two hammers, which were roughed out, and the eye formed at the rate of ten or twelve per hour. Figs. 261 to 263 show the dies and successive operations under the hammer. The punch *P* for the eye is of hardened

steel, and is screwed into the upper die, as shown in Fig. 261. The corners of the stock are first broken down in recess 1, leaving the piece as shown at *b*, Fig. 263, then the peen is formed in recess 2, the pieces being turned over

during the operation, after which the eye is formed by holding in 265 and punching one-half way through from each side; in this way *c*, Fig. 265, is produced.

A second heat is now taken, and the other end worked up in like manner. After separating, it is necessary to drift out the eyes and dress up the ends; very little work, however, is required, as a man can finish up four or five of these forgings

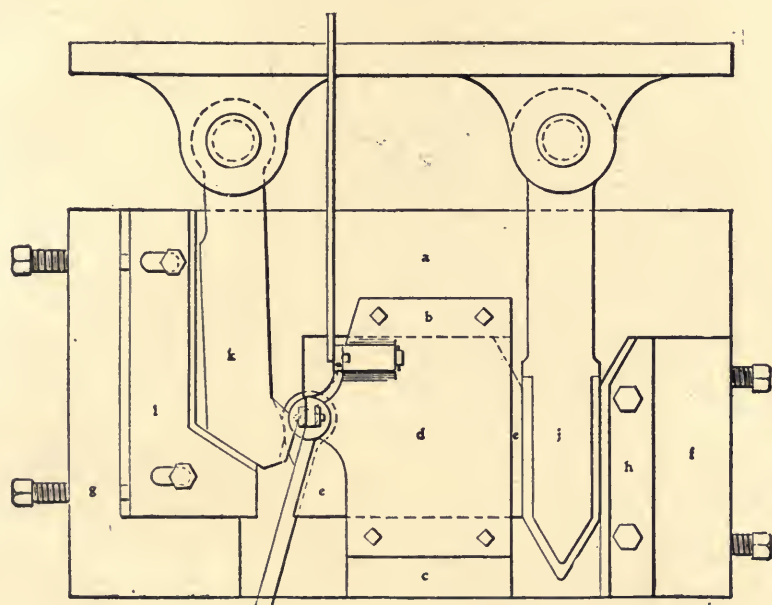
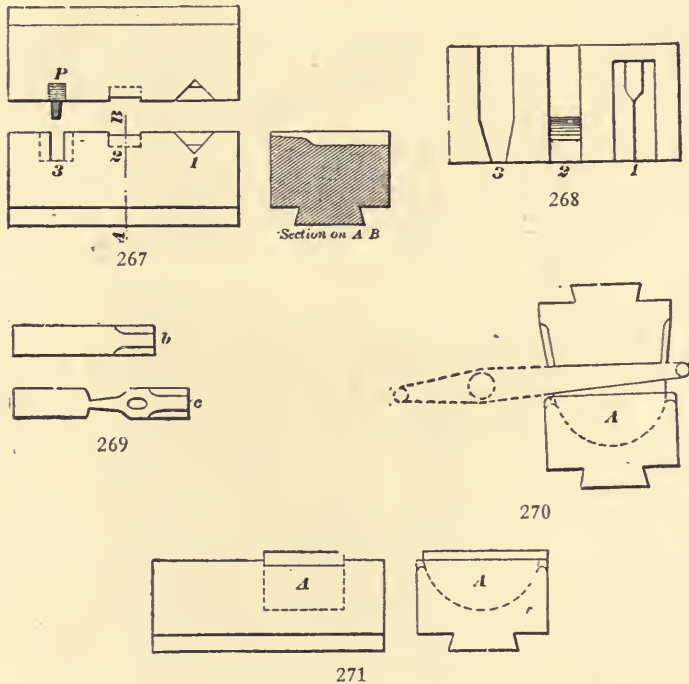

FIG. 266.—Bending eye-bolts in bulldozer.

in an hour. It occurred to me that a blacksmith's chisel could be cheaply formed in the same dies.

A die for working tapers of any angle in flat-iron or steel has recently been brought into use, and gives very good results as far as we tried. The device is very simple. It consists of a lower and upper die with a loose semicircular piece *A*, Figs. 270 and 271, which is free to slide in the recess cast in the lower die-block. This sliding block is of hardened steel and forms the working-face of the lower die. The upper die is a

plain flat surface. As long as the two faces are parallel the work will be parallel, but if one end of the work be lowered the loose block will be on its seat, thus producing the angle with the upper face, as shown in Fig. 270 where a piece of work is being drawn taper. As this angle is under the control of the workman, it will be seen that the varying angles, and



FIGS. 267 to 271.—Forging straight peen-hammers.

thus varying tapers, can be produced at will without separate dies. The loose block cannot be forced out of it, as the metal in front of the block in lower die acts as a stop when the work is held too low.

The writer was shown a pair of brakes which had been forged with these dies, the two ends being drawn out to a different taper, as shown in Fig. 270, and they were most satisfactory—the surface being smooth and free from hammer-marks.

The Advantage of Special Tools in Forging

The sketches in whole Fig. 272, numbered Figs. 1 to 9, illustrate how, with special tools, work can be done in the forge by so-called unskilled labor, and also how skilled labor,

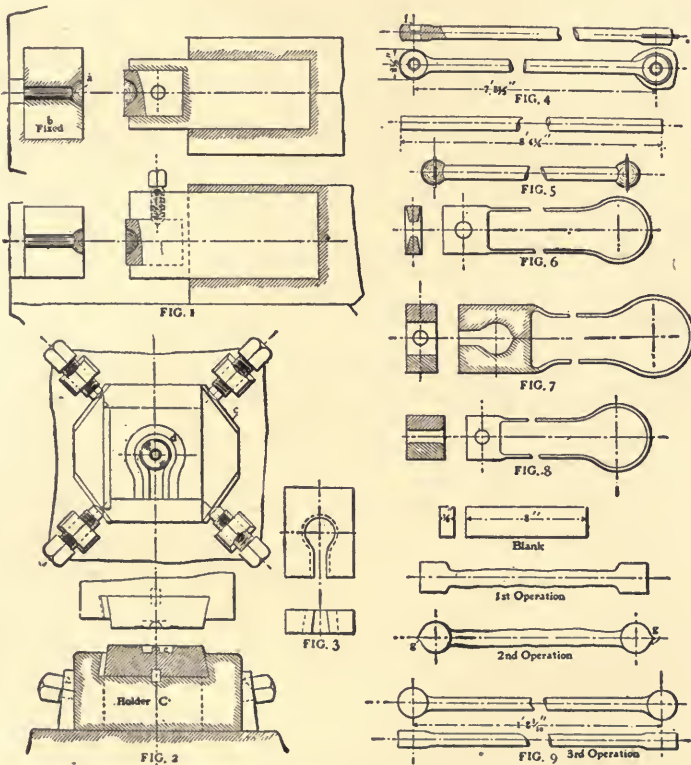

FIG. 272.—Forging with special tools and unskilled labor.

without special tools, even although the work produced will only occupy the same time, cannot compete in cost with the combination of tools and unskilled labor.

Fig. 4 is a tie-rod which is a part of the Westinghouse air-brake gear, as supplied to the New Zealand railways. This part was formerly made in the old way. The ends or eyes were forged and then welded to a $\frac{7}{8}$ -inch rod to the re-

quired length. This involved two separate forgings and two welds, and the smith had hard work to make this job pay at $6\frac{1}{2}$ pence, or 13 cents a piece. Later on, another firm took up this class of work and it was then run through in the following manner:

A set of cup-dies, to fit a bolt-heading machine, was made and fitted as shown in Fig. 1, as familiar to most of us. The block *a* is in two parts, and these are 3 inches apart when the machine is at rest. The heated iron is inserted against the face of fixed block *b* and up against a stop, not shown, which determines the length required to form the head.

The cam is engaged, the die-block closes on the rod automatically, holding it tight, and the moving head comes forward and presses the rod into the die *s*, forming a complete ball. These dies are made of tool-steel and hardened, the gripping surfaces being rough. When the furnace was properly going, the fuel used being oil, 60 heads per hour, or 30 rods could be figured on. The rods were heated for about six inches along the end, and the operator, who was a smith's helper, assisted

by a boy, made them to a length gage, the greatest allowable error of which was $\frac{1}{16}$ inch either way, the length of the rods used being carefully determined beforehand by experiment.

These headed rods were next handled by the 300-pound drop-stamp, and Fig. 2 shows the dies for stamping the eye, and also how the lower half die is held on the hammer-base. The corners of the gray-iron holder are cut away at an angle of 60 degrees, so as to permit of a slight rotative adjustment, the sides also have a slope upward so that the holder is held against its seat by the adjusting screws. This is very convenient for the operator in adjusting his dies, and helps to lessen

Order issued	March-30-04	
Material req'd	soft Steel $\frac{3}{8}$ " dia. 100" long	
Issued from stores in 300 lots.		
Heading die	B. f. 34	
Stamping & Trimming	DIES	D 2. 34
Shipped	April 7, '04	300
"	" 28 "	237
"	May 16 "	290
"	June 2 "	343
"	" 20 "	300
"	July 5 "	251
"	" 19 "	375
"	Aug. 1 "	312
"	" 15 "	301
"	" 29 "	294
"	Sept. 17 "	414
TOTAL		3493
Average Weight	16 $\frac{1}{4}$	
Total	56232	
Heading $\frac{5}{16}$ per 100	cost per piece 13 $\frac{1}{2}$	
Stamping $\frac{7}{16}$ per 100		

FIG. 273.—Time-card for the forging-shop.

the weight. The dies were made from tool-steel and carefully hardened so as to avoid leaving a curved surface. A groove, $\frac{1}{8}$ inch deep and $\frac{3}{4}$ inch broad, was milled all around the edges of the dies and $\frac{1}{2}$ inch from it, as indicated at *d*. This was done to make sure the dies would come close together and also to provide a space for the "flash" or fin to flow into. These heads were brought to a welding heat in an oil furnace and stamped to a length gage.

Fig. 3 shows the trimming-die which sheared off the flash. This was made of tool-steel and given a taper of 3 degrees. It could not be fitted to the ordinary trimming-press owing to the length of the rod, so the trimming was done in the following manner. When the eye was stamped the operator's assistant placed the trimming-die, which was comparatively light to handle, on top of the lower half of the stamping-die and to one side. The eye was then placed

in position by the operator, and with a slight blow from the top the flash was sheared. With the eye still inside the die he pushed the trimming-die off the stamping-block, then, quickly turning the rod which he held in his hands, the trimming-die dropped off on to a plate placed to receive it, so that the eye passed completely through and came out at the bottom side of the die.

Great trouble was experienced in getting the centers of the tie-rods correct. Even with a rigid gage attached to the base of a drop-stamp which held one eye while the other was being stamped, the error would sometimes be as much as $\frac{1}{8}$ inch, and as the holes in the eyes were drilled at the same time to exact distance they appeared to be out of center with the eye. To overcome this the stamping-dies which were plain were discarded, and a new set was made with a centering dowel, as

MARCH 14, -06	307 ⁸ DROP	3113
ORDER No. F.W.168		
Name of piece.	Tie-rod	
Index No.	69	
Quantity	3113	
Used on air brake for 4 wheel stock		

FIG. 274.—Time-card for the forging-shop.

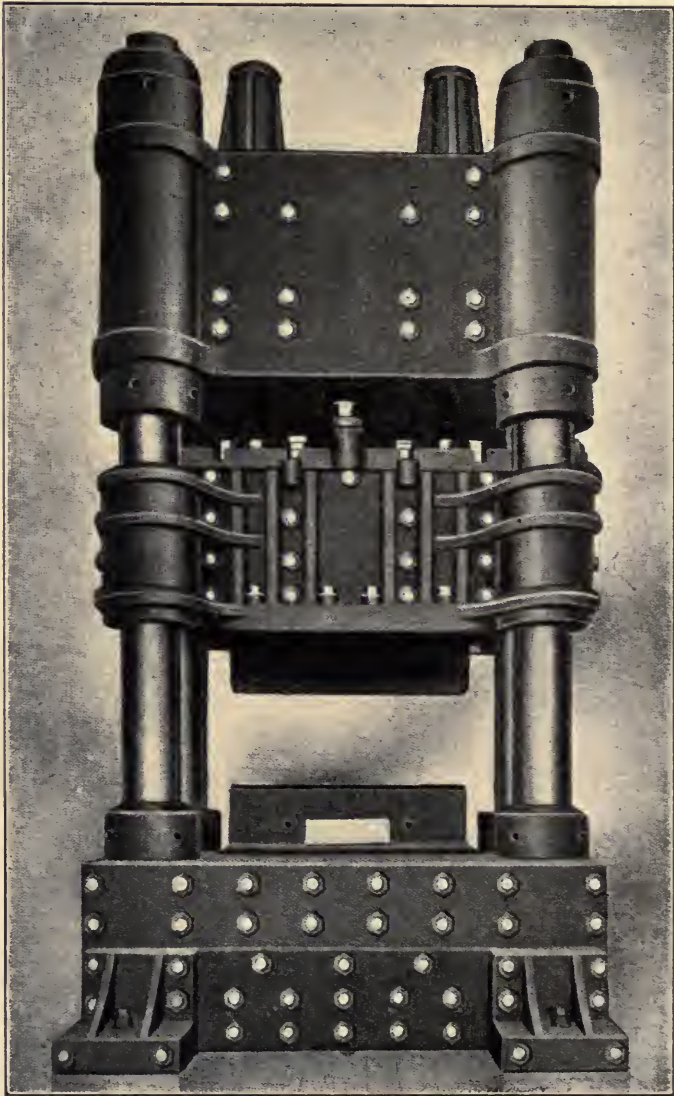

FIG. 275.—Ten-thousand-ton hydraulic press.

shown at *e*, Fig. 2, which did away with the drilling jig and as the drill followed the stamped hole, as indicated at *f*, Fig. 4, the error, if any, appeared in the center to center distance and not in the eye. Owing to the saving of material by this method, the heading-dies were reduced from $1\frac{3}{4}$ to $1\frac{5}{8}$ inches, and the rods were cut $1\frac{3}{4}$ inches shorter, which on a large quantity meant a considerable saving.

Forging Without Special Tools

The tools shown in Figs. 6, 7, and 8 and also the numbered operations illustrate the very best method of making a similar tie-rod of short length under a steam-hammer by a skilled smith. The rod is made in one heat. The material is heated in the bar form and cut off; then, by means of swages, Fig. 6, it is roughed out as shown in operation 1. Next, one eye is formed, and then the other, by the repeated application of swages, Fig. 7, and the hammer itself. Then the finishing swages, Fig. 8, are used to bring the rod to correct length, the tails *g g* being cut off at an anvil. I have watched the piece made in this manner many times, and have seen a forging laid down complete before the color had left it. I have also watched this piece being made by the former method as described and the results were a reduction of 80 per cent. on the cost of production by the latter method. There were no special tools in the latter case, as the swages used are in everyday use for general work in the forge.

The skill of the smith has thus been replaced by means of tools which eliminate all inaccuracy, the necessary handling being done by the operators who are boys and smith's helpers.

Figs. 273 and 274 illustrate a time-card for the forging-shop.

Ten Thousand Ton Press at the Dusseldorf Exhibition

The illustration (Fig. 275) shows a steam and hydraulic press, a model of which is exhibited in Dusseldorf, and the original of which exerts the trifling pressure of 10,000,000 kilograms, or 22,000,000 pounds. These presses, which are

made by the Kalker. Werkzeugmaschinenfabrik, are principally for forging and bending armor plates. There are three separate compressors and three separate ram-cylinders; and they are so connected that all three compressors act on all three press-cylinders, or any one or two thereof on all three cylinders. This enables the employment of the entire pressure of 10,000 tons, or of two-thirds or of one-third thereof, according to the need. The stroke is also widely adjustable at will. To give a slight idea of the dimensions of these presses (two such are at work in European shops) it may be said that the rear columns, which are each 17 meters in length, weighs 150 gross tons, and the three hydraulic-cylinders, that together with the steel-plate between them make up the upper platen, as much more. The lower platen, which is built up, weighs about 400 gross tons. The platens are held to the columns by sixteen nuts, each of 1,200 mm. (47 inches) diameter, and whose united weight is about 50 gross tons.

CHAPTER X

HYDRAULIC FORGING METHODS, AUTOGENOUS WELDING AND GENERAL SHOP PRACTISE

Hydraulic Forging

ONE of the great helps in making the modern automobile a commercial success was the advent of drop-forging. Imagine the thousands of automobiles built every year, fitted with hand-forgings—the very idea looms up before us as preposterous. Little perception is required to see that this branch of forging has attained a high position among the mechanical arts, and has prospects of further development and a wider range of usefulness in the future.

The essential features of drop-forging are a top and bottom die; each die containing half an impression of the forging desired, and means of raising and dropping the top die so that the heated bar held between them can be hammered into shape. This latter is accomplished with the drop-hammer.

The action produced on the heated metal by the blows delivered by the top die is peculiar to all hammers, whether they be small ones in the hands of a man or a large steam-hammer. This action consists principally in stretching the surface of the heated bar more than the interior, hence the metal has a tendency to flatten under the strain and action of the dies. At times it is with difficulty, and after the repetition of many blows, that the heated bar is made to perfectly fill the impression in the dies. Herein lies the cause which restricts this useful art of forging to certain shapes, and, therefore, sometimes limits its scope.

There is, however, another branch of forging that at present is not as highly developed as drop-forging, but promises

soon to be as important. I refer to that branch known as hydraulic-forging where, with the aid of dies, a piece of heated steel or iron is pressed or made to flow into the desired shape.

Description of Hydraulic Press

For the benefit of those who are not familiar with a forging-machine or press, a description of one will be given here. We will describe a large press. Most forgings made by pressing in shaped dies can be produced on a small press. The smaller the press used for accomplishing your work the greater the economy.

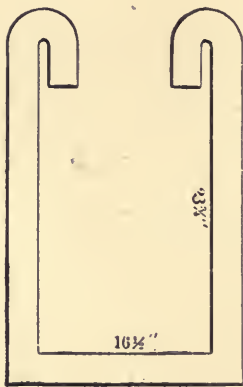

FIG. 276.—Forging practise.

Embodied in the press-proper is an operating plunger. This is pulled back after performing its stroke by a plunger. A platen is made movable to facilitate the handling of heavy dies. The dies are secured to the plunger and platen by means of bolts in tee slots. The press is usually operated by 500 pounds water-pressure. When greater pressure is required an intensifier on the left of the press is used.

It differs from the drop-forging method in that the force is comparatively slowly and steadily applied. One stroke usually suffices, while in the drop-forging method bars often receive dozens of blows and frequently are reheated several times. The action or motion of the heated steel in the dies is the secret of better metal in the forgings. In Fig. 277 is shown a heated piece of round bar between two dies. As the top piece is forced downward the metal flows, as shown by the dotted lines. The reason it assumes this shape, instead of that of a perfect cylinder, is on account of the friction between the faces of the dies and the metal, which sometimes restricts the flow of the metal next to the faces of the dies.

By making an impression in the dies, as shown in Fig.

278, we get a different result. The ends increase in diameter on account of the impression in the dies, and thus the flow is entirely confined to the center. As the die continues to descend the central portion increases in diameter but decreases in thickness, and is gradually formed into a flange, as shown by the dotted lines.

Next let us deepen the impression in the bottom die and use a plain cylindrical top die, as shown in Fig. 279. As the top die descends, the metal has a tendency to flow in the same manner as in the preceding examples, but is restricted by the side walls of the bottom die. It is compelled, therefore, to

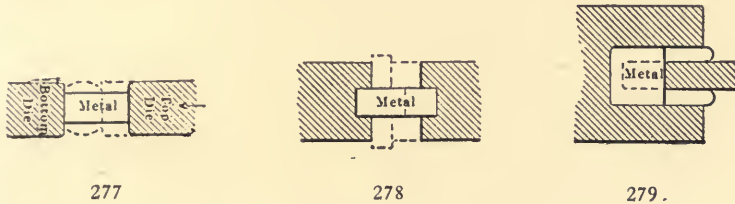

Figs. 277 to 279.—Hydraulic forging practise.

flow through the open space around the top die and makes a cup-shaped forging.

By shaping the bottom die, and pointing the top die or punch, as shown in Fig. 280, you have the shape used for making projectiles. The top punch must not necessarily be circular in form, but may be square, triangular, or any odd shape that does not weaken it or destroy its strength.

A good example of this is found in a patented projectile. Instead of the cavity being smooth it is ribbed, as shown in the cross-section in Fig. 281, the idea being, that on account of these internal ribs the shell will be broken into a larger number of small pieces, and thus increase its efficiency as an offensive weapon. These ribs are obtained by simply corrugating the punch, which, of course, leaves corresponding impressions in the metal.

In Fig. 282 is another example of simple forging. Hun-

dreds of shafts with 1-inch collars are needed. Instead of machining all that metal or drawing it out under a hammer, you simply heat one end of the bar where the collar is wanted, and with one stroke of the press squeeze it out, as shown by the dotted lines.

Examples of Production

These simple illustrations are merely suggestions showing the usefulness of this art in the commercial world. By a combination of different dies and several operations, difficult forgings of the most intricate shape can be economically produced, and with such accuracy and smoothness that only those parts in contact with their working parts need machining.



FIGS. 280 to 282.—Hydraulic forging practise.

The shapes shown in Fig. 283 are a few of the forgings that can be produced by this method. The only limit to the size of the forging is the capacity of the press used and the facilities for handling them.

From the sketches you will notice that the dies for forming the various shapes are not expensive, as they generally consist of shapes that can be produced by either a lathe or some other machine-tool. Hand-work seldom enters into their construction. For practically all shapes the bottom die can be made of a good grade of iron cast approximately to size, finishing only the base and the impression.

Dies of the kind shown in Figs. 279 and 280 must have a slight taper to facilitate the removal of the forging. This, however, needs to be very small, as the steel immediately com-

mences to cool, and in so doing it contracts and loosens itself. The castings used for this purpose must be solid and free from all blow-holes, however small, as the great pressure put upon the steel will force it into minute holes and prevent the forging from being withdrawn.

The top die, when it has no piercing or punching to do, may also be made of cast iron, otherwise it is made of steel.

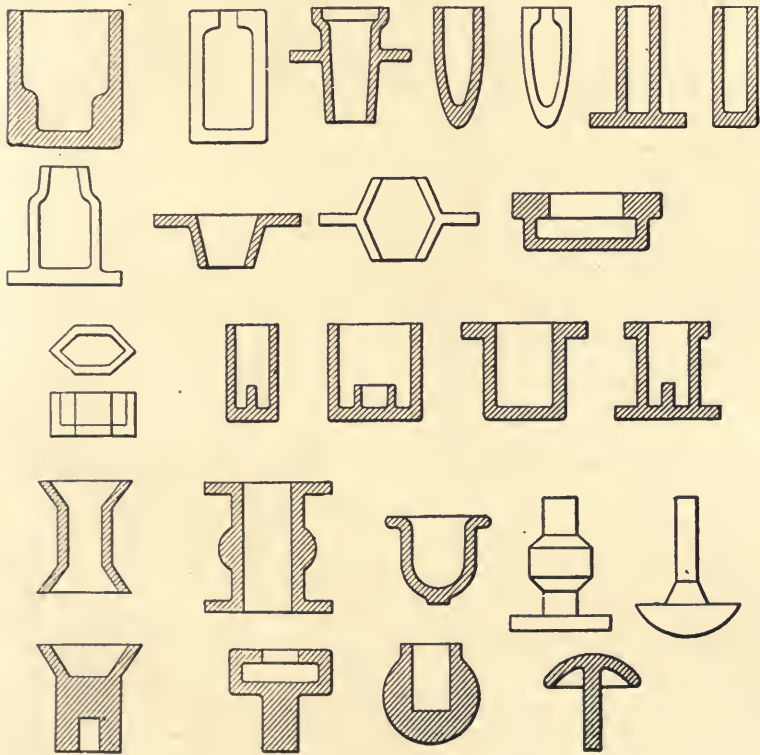

FIG. 283.—Shapes produced by hydraulic forging.

A good grade of forged steel is then required, one containing between 0.60 and 0.70 per cent. of carbon has been demonstrated to give excellent results. If lower in carbon they bend and distort too readily from the great pressure. If higher in carbon they usually crack from the alternate heating

and cooling of the punch, as water is turned into the dies after each operation to keep them below a destructive temperature.

Proper Practise for Hydraulic Forgings

Engineers who design forgings for production by this method will be wise to carefully note the following:

Make your punches practically straight, with a nice rounding at the bottom, as shown in Fig. 284. At first glance the punch in Fig. 285 would seem to require less pressure, and hence for a given pressure would give the metal a deeper

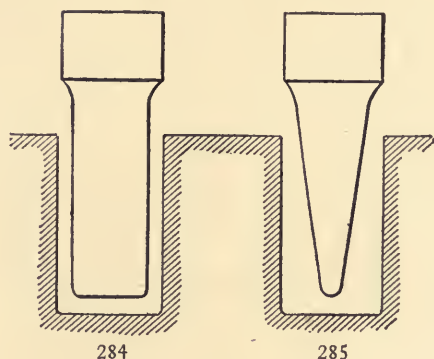

FIGS. 284 and 285.—Shaping of forging punches.

punch. The reverse, however, is the case, and the reason is this: When punch No. 10 enters the metal it displaces a certain amount and this must flow upward along the side of the punch. As the punch continues to descend, the area of the opening at the top of the die is gradually growing smaller, due to the taper, hence the metal must flow upward faster than the punch descends to compensate for the difference between the area of the opening and the metal displaced. This would make little difference with a perfect liquid, but creates tremendous friction with steel and greatly reduces the penetrating power of a given force.

Again, assuming that the pressure applied to the punch is downward, laying out a parallelogram of forces, we find that

the resultant is divided into two forces, one acting along the face of the punch, and the other at right angles to it. The one at right angles to the face of the punch is of no value in displacing the metal, as its power is expended in jamming the metal against the sides, tending to tear the die apart. No such conditions exist with a punch similar to Fig. 284. Here the area of the opening around the punch remains the same during the pressing, and the metal flows at a uniform rate of speed as the punch descends. The force tending to tear the die apart is small compared to a greatly tapered punch.

In this class of forging it is not absolutely necessary that the dies be of one solid piece. Many forgings require them to be split, and there are cases where five and six parts were required to complete one diameter. In such instances the dies are supported by an outer casing.

The variety of metals that can be forged by this method is practically the same as for drop-forging or hand-forging. Wrought iron or steel low in carbon, say, from 0.10 to 0.20 per cent., is forged with the greatest facility. The grade of steel commonly known as machinery steel, ranging from 0.30 to 0.40 per cent. carbon, is readily shaped, while steels ranging from 0.70 to 0.90 per cent. carbon are forged daily in the manufacture of projectiles. Alloy steels containing either nickel, chrome, or vanadium, or all three, are also forged in the manufacture of armor-piercing projectiles, automobile parts, cutting tools, etc. The higher the grade of steel used the closer the attention required in the heating prior to forging. Steels high in carbon and chrome cannot be made to flow quite so readily and require great pressure.

Some Applications of Autogenous Welding

The oxy-acetylene autogenous welding process found a large field in a number of manufacturing establishments. It is most commercial in shops where there is a large variety of work. It cannot compete with multiple machine riveting or with expensive coke and gas welding installations.

The objection to a coke-welding installation is the high

first cost, and the injurious oxidizing effect, due to the long exposure of the hot metal to the atmosphere.

On the other side, a gas-welding installation is only suitable for very large shops, due to the high cost of the gas generators, gas-holder, power-hammers, and presses.

The problem in all welding operations is to work the hot metals rapidly, or to heat only a small section at one time.

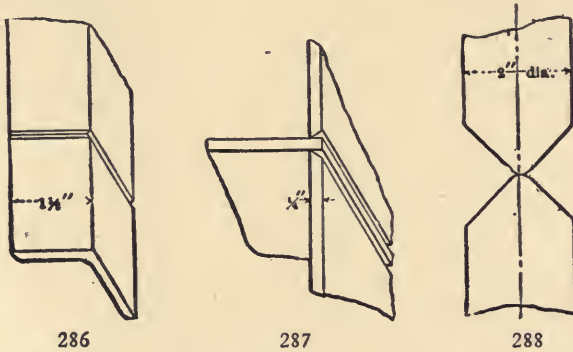

FIGS. 286 to 288.—Applications of autogenous welding.

The oxy-acetylene process will furnish the right temperature for fusing the metals, without oxidizing the joint.

Heating Metal Before Welding

The trouble that might arise, in this welding process, is that the metal is too rapidly chilled, which would tend to weaken the joint.

This difficulty can be overcome by heating the metal before welding; in which case we gain both better efficiency of the joint, and higher speed in welding. It is advisable to cover the heated metal as much as possible, to prevent excessive radiation, and to protect the welder from the high temperature.

In some cases, where a high efficiency of the joint is expected, it is advisable to anneal the welded piece in a slow-cooling furnace for several hours.

It is well known, that in all rapid welding, such as elec-

tric, and to some extent autogenous welding, the joint is stronger than the section next to the joint on either side.

This can be explained by the fact that a molecular distortion takes place between the hot and cold parts, and these molecules have no time to readjust themselves before the metal commences to chill. By the preheating and annealing process the distorted molecules will find their proper place again, and each will take its share of strain exerted by an external load. Experiments prove that with the same ultimate strength, the annealed piece will show a better elastic limit, and also a better ductility in the welded joint.

Fuel for Preheating

The preheating can be accomplished by natural gas or oil, or if power is cheap, by means of a resistance type electric furnace. The latter method is the most convenient, since it interferes least with the welding operation.

Fig. 286 shows the method of welding two angles together.

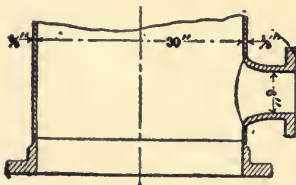

FIG. 290.—Welding top of cylinder.

Fig. 290 shows welding of a top in a cylinder for light pressures.

Fig. 291 shows two plates ready for welding, with scarfed edges necessary from 1/8 inch up.

Fig. 292 shows a cylinder with a welded cast-steel nozzle, and a forged flange welded at the end.

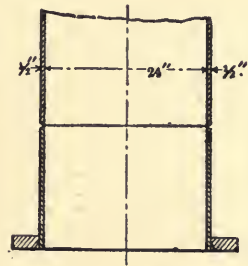

FIG. 289.—Welding tube and flange.

Fig. 287 shows a more complicated section, welding in a partition in a tank.

Fig. 288 shows the method of welding shafts, or any cylindrical sections.

Fig. 289 shows butt welding of large tubes, at the end of which a flange is welded on.

Fig. 293 shows welding a dome in a cylinder, a flange at the bottom, and an outlet at the side; all for high pressures.

Welding Conclusions

The process of autogenous welding is well adaptable in any metal work-shop, and will pay good returns for the small first cost, and operating expenses.

The welding operation is not difficult, but requires several months of practise, to turn out reliable work for high pressure.

The process does not require any expensive machinery, such as power-hammers and presses.

Over 1,000 installations are in daily use in Europe, and bring good returns on the investment.

We believe that in the next few years a new field will be

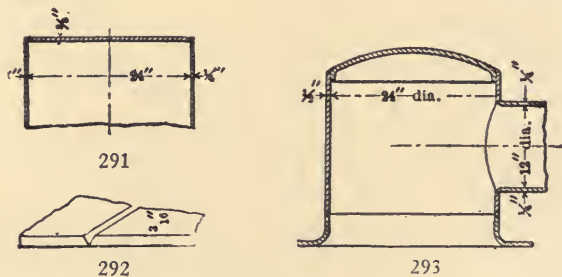

FIGS. 291 to 293.—Welding cast-iron nozzle and flange on cylinder.

open for the autogenous welding process, in boiler shops, automobile works, tank and plate works.

Built-up or Welded-up Die Work

A question that is often asked me by those about to make a lot of sheet metal working dies is this: "Shall we make them of solid steel; and, if so, what kind, and how can we get them forged so as to save stock and labor?"

My experience has been this: If you have got a smith who knows his business and can do a good job, weld them up; but I have never yet found more than one or two shops that could do this trick and be sure how it was coming out. I am well

aware that there are two or three firms in the business who can take, say a 12-inch round die, and weld up the steel ring, and weld the same on to a wrought-iron plate, and be sure of good results, before it leaves the smith's hands, and they can do this every day in the week. If I had a man like that, I would never make another built-up die like Fig. 294; but one doesn't find such a man on the corner waiting for a job; he has one already.

At one time I had a lot of dies, six, I think, to make, all square ones; and, failing to get good results from the smith, I ordered six blocks from the mill. They were 12 x 14 x 2 inches thick, one-half steel and one-half iron. They came in course of time (about sixty days, I believe), and they looked nice. I started three of them; cut out the dies and hardened two of them all right; but the third one parted in the weld, so it was useless. Well, I fitted the punches to the other two and started them to work. By the way, did you ever think it was a great deal better to make a die for your own use than for somebody else to use? It seems to work better, and a complaint from the boss of the press-room doesn't sound so big as one that comes in a letter—especially if it is a typewritten one.

Well, the dies worked very well until they were worn down to $\frac{1}{4}$ inch of steel, then one of them began to "peel," as the press-boy called it. The vibrations caused by the punches started the weld at one end of the die, and it kept "peeling" until it was two-thirds of the way across and then we had to scrap it. The rest of the blanks I had planed up and let the boys have them for bench-blocks. They were a little expensive, but they were good ones.

There was one fault with these dies that is common to all welded dies, except round ones; that is, the impossibility of making a perfectly square blank, and the enlarging of the blank caused by the clearance given the die. To overcome this, we finally made a die like Fig. 294, the sides and ends of separate pieces, and the corner dovetailed in. All the pieces were got out on the shaper, drilled and tapered for the holding-down bolts (not shown), then hardened and ground to an exact fit, then set in the cast-iron bed, and held in place

by the set screws shown. The cost of the die was about the same as for a solid die, and as I could use cheaper labor for most of the work, but as it did about double the amount of work done by a solid one, and the work was far better, I called it a cheap die, and we made the rest in the same manner.

Now, I take this view of the matter: If I had a smith that could weld up a 12 or 24 inch ring on a wrought-iron plate, and be sure of his work I think it would be cheaper and better to do so, but rather than take chances of a second-class man, I build them of steel rings set in cast-iron blocks. Of course, in some cases, the cost of steel should be taken into account;

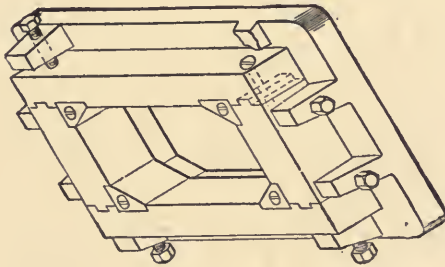

FIG. 294.—Built-up die.

but when the work in the smithy costs eighty cents per hour, and the steel seventeen cents per pound, it doesn't seem to me that the cost of the steel cuts much ice anyway.

All the punches were made solid and left soft, which I think is the best way for thin stock.

General Practise for Hardening Drop-Dies of Various Steels

It was formerly considered necessary to make all forging dies requiring to be hardened from crucible tool-steel, but experience has proved that for certain classes of work a good grade of open-hearth steel of the proper carbon gives results which justify its use. In some shops this steel is used altogether, but the results are not very satisfactory for dies with small projections or for shapes that weaken the die.

There are various makes and grades of both open-hearth and crucible steel, and a make which gives satisfaction in one shop may not do so in another.

When heating for hardening, some hardeners place the die in the furnace, face down, on a layer of powdered charcoal; this is supposing that we are using a furnace where the die does not come in contact with the fuel. I know a hardener who gets excellent results heating in charcoal in an open fire, built specially for the purpose. I have had best results, however, when heating in furnace—a case-hardening furnace works nicely—the die being placed in a box having an inch or so of wood charcoal or charred leather, preferably the latter, in the bottom. The box should be shallow, so as not to come up on the side of the die more than 2 or 3 inches when it is resting on its bed of charcoal or leather.

The heat should be applied strong enough to heat the die as rapidly as possible consistent with uniform heating, and no faster, or some portions will become overheated, and this will cause strains which may cause the steel to crack when hardened.

As there is a tendency to heat the beveled edges of the tang more rapidly, and to a higher heat than the rest of the block, it is good practise to fill in the corner with fire-clay mixed with water, allowing it to dry before placing in the furnace.

When the die is uniformly heated to the proper heat, remove the box from the furnace, then remove the fire-clay from the corners of the tang. In order to keep the tang from humping when the die is hardened, it is best to stiffen the tang before hardening the face. This is done by placing the die on the wires in the bath tang down, so that the water is projected against it. While this portion is cooling, the corners of the die may be slapped with a wet cloth to cool them somewhat before hardening the face. Any very delicate projections that are liable to cause trouble may be oiled or rubbed with soap, to prevent the water acting too quickly on them.

When the tang has cooled so that no red can be seen, the die should be inverted, and the water allowed to play on the face. At the same time water should be poured on the tank until the red has disappeared from the face, when we should cease cooling the tang, and allow the heat in the center of the die to run out through this portion.

The overflow in the tank should be so regulated that the water will only come up on the face of the die about an inch. Of course, it will be forced up the sides of the die by the flow of the water in the supply pipe.

The pipe delivering the water to the die should distribute it directly against the whole face, rather than in a solid stream, striking all in one place. Make the top of the pipe

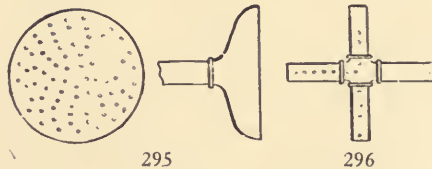

FIGS. 295 and 296.—Piping for drop-die hardening.

in the form shown in Fig. 295; or a perforated top to the supply pipe, as shown in Fig. 296, is excellent.

In winter some means should be provided for removing the chill. This can be done by entering a steam-pipe into the supply, when any desired degree of heat may be obtained.

To eliminate, so far as possible, the tendency of the steel to crack from internal strains set up by the process of cooling, the die should be so heated as to promote this result. Some hardeners think it advisable to do this by drawing the temper. This seems to work all right if the heating is done slowly enough for the heat to penetrate to the center of the block; but if the heating is rapid, this result is not accomplished, the strains are still in the steel, and may manifest themselves at any time. The die may crack after being placed on the shelf, or it may not until some time after.

Knowing the tendency of large pieces of hardened steel to

crack from the cause mentioned, it is best to take every precaution to prevent this. A very inexpensive method consists in placing the hardened die in a water-tank which has a steam-pipe connected with it. Steam is let in and the water is gradually heated to the boiling-point, and kept there for several hours, when the die may be removed and the temper drawn. If it is not thought advisable to use this method, place the die where, to insure uniformity of heating, it will heat slowly, and continue the heat until, when touched with a moistened finger, a snapping sound is heard. In order to effectively avoid the tendency to crack from internal strains, the heating must be slow enough to insure the penetration of the heat to the piece.

It is often desirable to draw the temper immediately after the hardening; when this is the case the greatest possible care should be exercised. A die having slender projections or light, irregular portions, if heated faster than the steel can absorb the heat uniformly, will of course become hottest at the lighter portions, and these expanding faster than the solid portions adjacent, will tear themselves away. Where there are such light projecting portions, it is often advisable to fill the surrounding depressions with oil; this will prevent a too rapid heating of the parts and stop their "snipping off."

Sometimes, and for certain work, it is not necessary to harden the dies, but it is still often advisable to stiffen the steel somewhat under such conditions. The die may be heated and then cooled in oil. A bath of generous proportions should be used having a jet of oil coming up from the bottom, this striking the face materially aids in producing the desired effect.

When open-hearth steel which contains a sufficient amount of carbon works well on many dies, its use is not advocated for dies that must be very strong or that should retain their sizes, as cold-drop dies. A good grade of crucible die-steel, containing a higher percentage of carbon can be used which will harden much deeper and harder than the open-hearth of lower carbon.

The crucible steel, being lower in percentage of harmful impurities, can safely have a much higher percentage of carbon and yet be less liable to crack than the open-hearth material.

After all, the real essential for successfully doing work of this kind is brains; it is necessary to discriminate between the dies of different sizes and shapes, also to judge correctly of other conditions, and then act accordingly.

CHAPTER XI

HIGH-SPEED STEEL, DROP, AND HYDRAULIC FORGED CUTTING TOOLS, DROP-PRESS PRACTISE, AND HARDENING DROP-DIES

What is Good Judgment

A GREAT deal is heard of good judgment, and the man who possesses this quality commands a high salary. Often a machine-tool establishment which has secured such a man, depends almost entirely on his "good judgment" for better results, and it is often considered that with this he can overcome the lack of organization, cost system, or even of plant equipment.

A manager with good judgment is extremely valuable, but he must have the tools with which to work. If he does not obtain them a man of less ability, with better organization and with better equipment, will outdistance him. The same applies to the man in the shop—the mechanic. A good mechanic, to produce the best work quickly, must have good tools with which to work. If he is not given these, a less efficient man with better tools can produce better results.

Good judgment, as I see it, is the application of knowledge gained by experience. This is derived partly by direct observation, familiarity with the accomplishments of others, and partly from statistics compiled by others, which have been digested and the valuable points retained. If the manager is really a man of "good judgment" he will provide himself with the organization and the system which will furnish him with correct information. If the manager's works superintendent is a man of "good judgment" he will insist upon an

equipment of machines and tools which will allow of his mechanics producing good work rapidly.

High-Speed Steel and Tool-Holders

An important item in machine-shop organization and management is the speed of cutting tools and the use of cutting tool-holders. The speed of the tool is limited by the frictional heating of the tool, and its consequent softening by drawing its temper, so that for wrought-iron and mild steel the limits were from 10 to 30 feet per minute. Some increase was made on the introduction of a self-hardening steel in which higher speeds were attained. But these tools were rapidly broken down in wear or were abraided out of shape. Within the past ten years there have been introduced various brands of high-speed steel, cutting three, four, and in some cases even six times faster than the best tool-steels of the recent past, and also possessing a remarkable durability. In some cases the tools are heated to a dull red in the operation of cutting, while the chips are nearly as hot. This steel will stand long, severe, and continuous usage without regrinding, and this, together with the increased strength, effects a great saving in time and labor, otherwise wasted in removing, grinding, and replacing the tool. Deeper and wider cuts can also be taken with this steel, and this, together with the high-speed results in removing a far greater weight of metal per minute with a consequent considerable cheapening in the cost of production.

Speeds of from 75 to 100 feet per minute upon medium hard-steel have been attained in ordinary work, while roughing cuts have been made at the rate of 140 feet per minute on cast iron with $\frac{1}{8}$ inch feed and $\frac{3}{8}$ inch deep.

Though the cost of high-speed steel is considerably greater than that of common tool-steels, the difference in cost is more than covered by its labor-saving qualities and reliability. The best steel I know of for high-speed cutting costs about seventy-five cents per pound, and—for machine-cutting tool purposes at least—is not forged into solid tools, as in the old-fashioned way, but the cutting portions are forged and ground,



FIG. 297.—Shanking dies with high-speed cutting tool.

then inserted in a tool-holder and held by a simple plunger and locking stud, as illustrated and described farther on in this chapter.

Combination Tool-Holders and Their Use

The high cost per pound of the high-speed steels and the large waste of this valuable material by individual users and forgers of bar stock, where cutting-tools are forged from the bar, has brought about a truly wonderful demand for an efficient substitute for expensive forged tools—a substitute which shall possess all the best qualities of the bar-forged tools without their waste, uncertain heat treatment methods, and prohibitive expense. This substitute I believe—after careful personal investigation and use of various tool-holders—is secured in the combination tool-holder manufactured by the O. K. Tool Holder Company, of Shelton, Conn., as it is the only one I have ever seen and used which compares in efficiency and strength with the best high-speed tools forged complete from bar stock.

Though experiments have been conducted by almost all users of high-speed steel to determine the best shop-practise for treating it, the results of these experiments as a whole seem to have given us a general shop rule for treating a high-speed steel-tool: "Heat it to a white heat and quench it." But this, in my opinion, has its shortcomings, because a variation of 50 degrees Fahrenheit cannot be determined by the eye, but such variation is very important, especially in the tempering of these steels.

The results of poorly treated tools are: A decrease in shop production for the manufacturer, who allows it inside his establishment; dissatisfaction and poor work on the part of the machinist who uses it; an increase in the bill to the buyer of the shop's products, and the entire result a waste of energy and capital.

Therefore, I argue, the fact that perfectly finished, uniformly treated, and guaranteed efficient high-speed cutting-tools can be purchased direct from specialist makers, makes

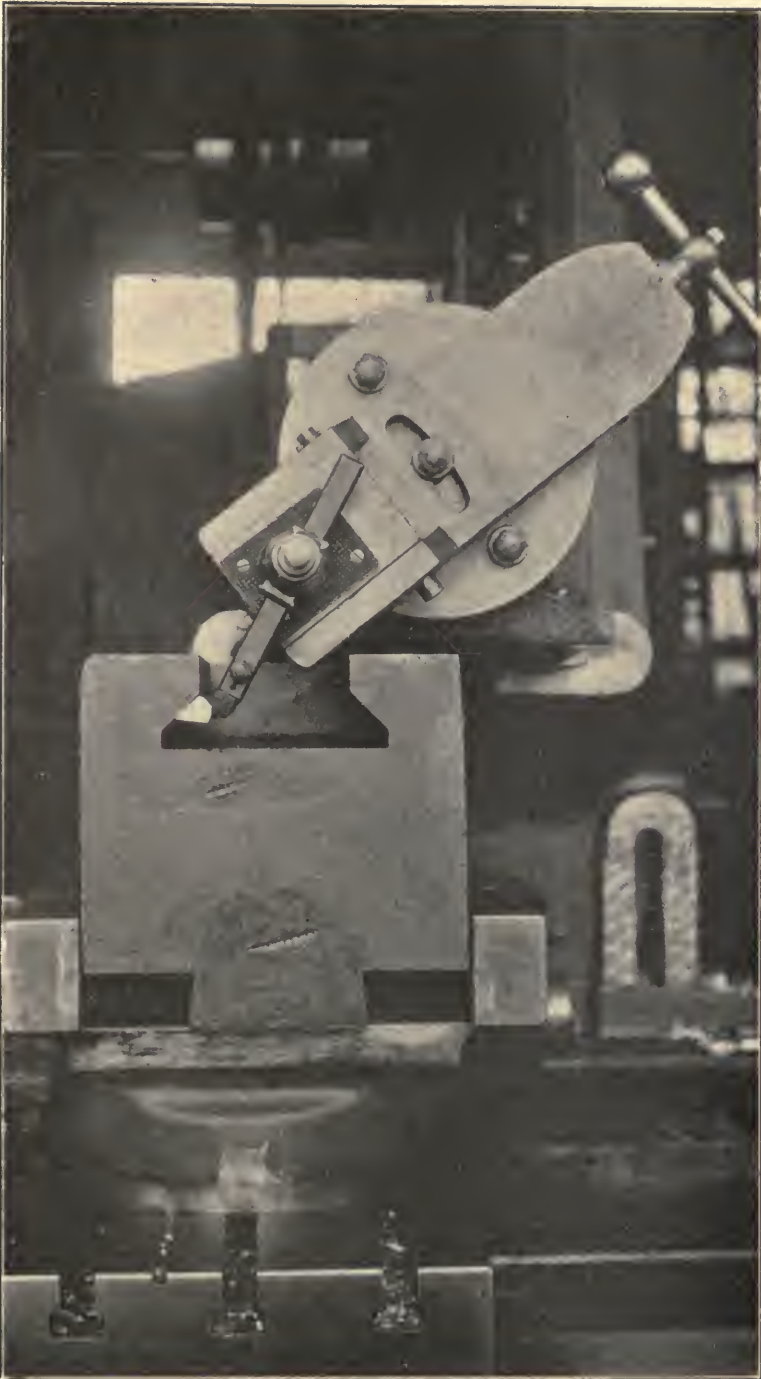

FIG. 298.—Finishing cuts on heading die with high-speed cutting tool.

this waste of energy and capital on the part of users of such tools inexcusable.

Economy in Use of Tool-Holders

On many operations of die-work a tool capable of removing stock at high-speed with corresponding heavy cuts is very



FIG. 299.—Complete set of high-speed cutting tools and their holders.

desirable. Formerly solid-forged tools were necessary, but modern practise demands the more economical tool-holder. A very efficient type is shown in Figs. 297 and 298. As will be seen, this holder is a radical departure from the old style

holder. The holder itself is made from a tough grade of steel designed to stand the shock and strains of heavy cuts. The cutting-points are hydraulic and drop-forged from high-speed steel, and are made exact duplicates of the solid-forged tool-cutting ends, *having a large body of metal to soak up the frictional heat generated by the chip.*

Each tool is provided with a round shank fitting the receiving-end of the holder and is prevented from turning by contact of the plunger at the flat back of the tool, which in turn is forced ahead by the tapered face of the locking-stud. This method of locking gives practically solid backing to the

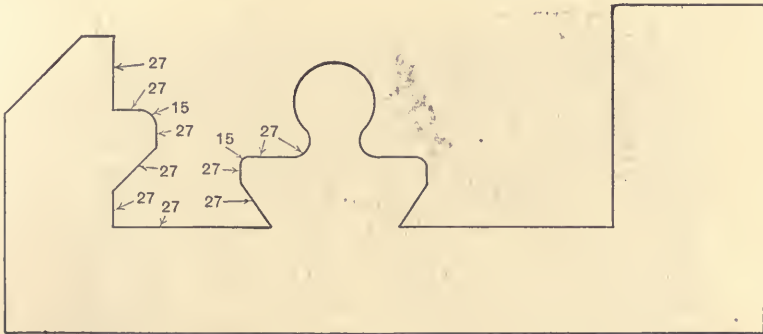

FIG. 300.—Plan of trimming die showing utility of high-speed steel cutting points.

tool, there being no possible chance of the point slipping away from the work.

One commendable feature of this holder is the entire absence of set screws, the lock, consisting as it does of a loose plunger, stud, and nut, can be instantly removed if occasion requires. Fig. 297 shows the method of shanking die-blocks with this tool. The head of the planer is first set over to the required angle on the side of the shank, and with the cross-head feed successive cuts are taken downward to the required depth, thus leaving no angular corner to remove with short light cuts. At the right is shown the tool used to undercut the side and base of shank. By this method very

close estimates on time may be made by ascertaining the number of pounds of stock to be removed, as the number of cuts may be figured to a certainty—half an inch in width being the average cut.

In Fig. 298 is shown a tool used for finishing side and base cuts on a block for a heading-die, this block being entirely finished with a standard shaper set of these tool points.

Fig. 299 shows a trimming-die, and well illustrates the utility of some of these shapes, the No. 27 tool being suitable for finishing the entire face, both right and left. For rough-



FIG. 301.—Set of O. K. tools and holder.

ing work the Nos. 9, 12, 5, 6, 11R, 11L, 104, and 10L are suitable. All have been found excellent for their particular purpose or operation. It is to be noted that there are no side projections to this holder, which makes it especially good for trimming die-work. In Fig. 301 is shown an assortment of tools and holders made in several sizes. With an assortment of these standard shapes the machinist, die-maker, or tool-maker is enabled to do his work rapidly and accurately. In visiting one large die-sinking establishment recently, nearly 100 of these holders were seen in use on various parts of die-work and in maintaining tools for such work, having made a place for themselves by their great adaptability to all conditions and

their durability. Four of our leading machine-tool builders send sets of these tools as part of the regular equipment of their new machines.

Forging the High-Speed Steel-Cutting Points

The most distinctive feature about these cutting-tools is that, instead of being forged complete from bar stock used as it comes from the mill, each cutting-point is forged to shape between dies in a hydraulic press, the most desirable conditions being attained in the finished product.

When we consider the most essential conditions necessary to high-speed steel-cutting efficiency, we find that the processes involved in the production of these cutting-tools are such as to insure the accomplishment of these most essential conditions.

The first is rigidity. In order to obtain the best results there should be absolutely no spring in the tool away from the work. Too much importance cannot be attached to this feature, as it is a principal that is very important in obtaining the maximum results at the minimum of expense and labor from machine tools. Cutting-tools of the solid forged type were heretofore considered necessary to accomplish this rigidity, as all machine-tool builders aim to build their machine more powerful than the cutting-tools used in it.

Secondly: there must be sufficient body of metal forged in the cutting-points to rapidly soak up the heat generated by the friction of the chip against the cutting-edge. This friction on cast-iron work fuses the metal to the top of the cutting-point. On steel, however, where the chips have more of a sliding action, the top face of the tool becomes worn away, in some cases to a depth of $\frac{1}{16}$ inch, as shown in Fig. 303, but this wear takes place well back from the cutting-edge. This condition seems peculiar, but is explained by the fact that at the angle of shear, the stock is crumpled and crushed and adheres to the tool, thus protecting the edge, and the sliding action that curls the chip starts at a point back of

the shear, or where the leverage is sufficient to start bending the chip.

Third: the tool must have the correct angles of clearance and top rake. The top rake must be such as will separate the chip from the body of metal in a manner to generate the least possible heat in proportion to the metal removed.

Lastly: the tool must be forged, hardened, and tempered in the best possible manner, a thing which only long experience and continuous specialization in perfecting this product can accomplish.

The forging process used in making the tool-holder and points described and illustrated here is the result of long and

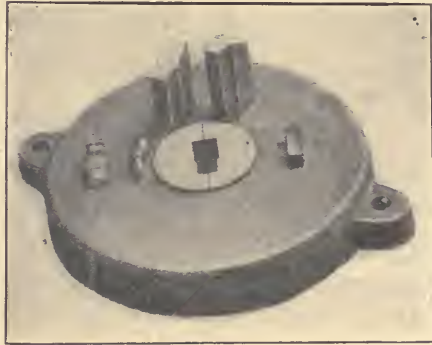

FIG. 302.—Hydraulic forging-die for first operation.

patient experimentation, and also wide experience in the handling of high-speed steels; and the applications and details of this process interested me very much when I visited the O. K. plant late last year.

I will digress here to state that these people have specialized so much in the cutting-tool business that they maintain an experimental department for the sole purpose of being in a position to know at all times the best grades of high speed steel obtainable. The result is that they are obtaining a grade of steel from Sheffield, England, which their experiments lead them to believe is the best there is, and which they are recom-

mending and guaranteeing to their customers, for use in milling cutters and other uses where high speed steel is required, on the results obtained by them in their experimental department in fair and square tests with other steels.

Starting with the commercial bar of high-speed steel the pieces are cut off in a press, great care being taken to have each piece of uniform weight *instead of size*. To secure this an accurate balance is placed on the bench behind the operator, a standard forging being in the pan for a weight. The first piece from each new bar is tested; and should the weight vary, owing to a slight difference in the size of the bar, the stop in the cutting press is adjusted until the weight is absolutely correct. This not only saves stock, which is quite an



FIG. 303.—A worm-cutter and its chip.

item with high-speed steel, but also insures a uniformity in the texture of the forging, as the same pressure is exerted in each case.

After the cutting-off, which is done hot, the pieces go to the forging furnace. The square piece of steel is then heated—in a special furnace of their own manufacture—to the proper forging-heat and dropped into a hardened steel retaining-die, upon a hardened steel punch that fits the profile of the die, both of which are shown in Fig. 302.

The top punch is then entered into the die, and under a 50-ton pressure the square billet is blanked, squeezed, and forged to the shape of the pieces shown on the left-hand side of the die in Fig. 302. The top punch is then withdrawn

and the blank raised by the bottom punch to a proper position on the top of the retaining-die, where it may be grabbed by the tongs and removed to the furnace to be reheated.

The forged blank is next passed to another press and dropped edgewise into another retaining-die having the profile of the finished forging, and the operation of re-forging is performed under 75-ton pressure. Fig. 304 shows the second retaining-die in its cast-iron plate with the blank and finished forging lying on it. At the left is the top punch and holder,

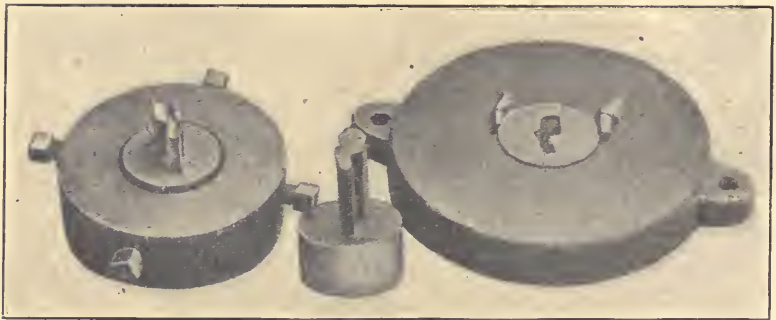

FIG. 304.—Hydraulic forging-dies for last operation.

the same type of holder being used on both blanking and finishing operations.

This method of forging cannot help but improve the grain of the steel. In all cutting-points the steel is used with the cutting-edge on the end of the grain. While this seems a small matter, it has been made the subject of careful study and has proved an advantage of great importance.

Another commendable feature of this forging-system is the high pressure exerted on the metal when forming the tool from the square to the finished shape in two blows, while the metal is confined within the walls of the retaining-dies. This compresses the grain of the steel and is admitted, by manufacturers of high-speed steel and the most advanced steel experts, to be an ideal method of forging cutting-points for steel and iron.

The Drop-Press in Flat-Ware Operations

The drop-press is a very important factor in the manufacture of German silver flat-ware. Many kinds are used by the various manufacturers of tableware. Some are still using the old style hand and foot drops, but they are fast being discarded for the improved lifters.

In using the hand or foot drop, it is necessary for the operator to pull the drop with a belt over a running-pulley, helping to lift the hammer for the blow required. But it is hard on the operator, as usually the work is placed under the hammer in the die with one hand while using the other to pull the hammer. Another bad feature of the hand-drop is the non-uniformity of blows on the work, as it requires a very experienced workman to lift the hammer exactly the same height and let it fall with the same speed on every piece of work put under the hammer. The economy of such drop-hammers can be considered only when small lots of each pattern are made, or when sometimes successive and varied blows are required.

Experience with several styles of drop-presses for work of the nature mentioned above has led to the conclusion that the best and most economical drop-press in use is an automatic drop-lifter. This conclusion has been reached by a thorough study and a varied experience in the past. One company is now running an automatic drop-lifter which has been in use eighteen years, and in all that time costing only three dollars for repairs. The hammer on this lifter weighs 1,000 pounds; altogether this whole machine to-day is nearly as good as new.

Three important features are necessary in drop-lifters. First, economy in repairs, etc.; second, the speed at which work can be produced, and third, the quality of the work. The drop-press which meets all these requirements is the only one to have.

Foundations for Flat-Ware Drop-Presses

The successful operation of any drop-press is, to a large extent, due to the manner in which the foundation is put under

the base. Many methods have been tried with varied success. The old method of placing a large log of wood endwise under the base of the drop and grouting around it, to hold it firmly, answers the purpose for a short time, but in most soils the wood soon decays and the log becomes useless; where this method is continued it becomes unsatisfactory, annoying, and expensive. The writer has tried several methods of setting drop foundations, and has come to the belief that for economy, stability, and good results, our present method is the best for flat-ware drops. Our method consists of excavating down from level about eight feet, and wide and long enough to give good, solid grout foundation, using small cobblestones and Portland cement. This we build up in the bottom of the excavation about four feet, then we put on about two feet of crushed stone, mixed thoroughly with Portland cement. We then procure a large stone about two feet thick and at least six inches larger than the base of the drop at all points. This stone we place on top of the crushed stone, then fill all around this foundation-stone with a crushed-stone grouting nearly to top of the foundation. After the cement work has become hardened, cut out the top of this foundation about one-half inch in depth and the same shape as the base of the drop, being sure that the cutting-out is perfectly level and true. We usually cut this receiving space about one-half inch larger at all points to allow for leading around the base. Now place the iron base in the cavity, being sure it is level and true, and proceed to lead the same. When the hot lead is poured into the space around the base, it makes all secure without danger of moving from position as long as the foundation stands firm. Such a foundation, if properly made, insures the best possible resistance to the blows of the hammer and gives best results in bringing up either plain or figured patterns in the dies.

Holding Dies in Drop-Presses

Several methods for holding the dies in drop-presses are used, and all may have some good features, but we find this to be the most practical one for spoon dies. It consists of what

we call a die-bed keyed into the top of the drop-anvil. This die-bed has a cavity long enough and wide enough and of proper depth to receive the die. In the center of the depth of the receiving-space we place six screws, two on each side of the length of space, and one each on the back and front of the same. These screws are of suitable diameter and length to hold the die firmly in place. With the six screws above mentioned we can adjust the die sidewise and endwise to align properly with its mate, which is held in the hammer by means of a key. We find this method of holding the dies for the striking up of flat-ware the surest, safest, and most practical of any so far devised. The dies used for striking flat-ware are of varied shapes. Flat, curved, half-curved, etc., to best suit the work desired.

Dies for Making Flat-Ware

The dies for making flat-ware are expensive. Therefore, quite an item to be figured in the cost of producing the goods. They must be made of the best steel suitable for the purpose that will stand the hard usage required of them. Whole pages might be written of experiments which have been made with different steels manufactured to find a make or brand entirely satisfactory in every way. If the cost of the steel only was considered we might all be satisfied, but the expense of cutting a pair of figured spoon or fork dies is another proposition, and many times greater than the cost of the steel.

Treatment and Use of Dies for Flat-Ware

The treatment of steel in the annealing and hardening process has a great deal to do with the wearing quality of the dies. The writer has seen some costly dies entirely ruined through neglect of simple principles in the handling, and long ago concluded that something more than water and fire was necessary to harden spoon or fork dies to get the best service from them. In the striking up of flat-ware we have many difficulties to overcome. First, we must be sure our dies are set correctly in the hammer and die-bed, and they must be exactly mitered one with the other, or our pattern on back and front of

the blank when struck will not be true to each other, and be thus made unfit for the finished piece of work. Second, the operator must keep the dies clean, as if any foreign substance adheres to the dies or blank it prevents the figures from coming up full and clear, and also shows bad places in the article. To show how careful the operator must be to have his work perfect when struck up, as an illustration we will take the finest human hair and place it on some plain part of the die and then place our blank to be struck over the hair and let the hammer fall. We find when we look at our blank that we have a cavity or indentation many times larger than the diameter of the hair, though practically the same shape. The requirements of a good drop-press operator are activity, good judgment, good eyesight, and positive watchfulness and carefulness to detect irregularities in die or blank.

Correct and Reliable Method for Hardening Drop-Hammer Dies Without Loss

Twenty years at hardening dies, employment in fifteen States at the same trade should give a mechanic an expert knowledge of his craft. This is the experience of the fellow mechanic from whom the methods and processes given in these last pages of this book was secured by the author. During this man's travels he was determined to find a way that dies could be hardened with perfect safety, and he found it. Referring to his record of one year and six months work, I found he had hardened 2,186 drop-hammer dies without the *loss* of *one die*. These dies were all subject to inspection by the foreman of the blacksmiths and die-departments as well as the man who used them. But not a die returned to be rehardened, and during this time not a die left the hardening-shop that could be touched with a file. This shop believed that its dies did best when drawn just to a light straw color.

These dies ranged in size from 16 to 500 pounds, and were just such dies as would be seen in any up-to-date forge-shop. They had their breakdown and finishing portions all in the same die, where it was possible to do so. So it can be seen they

were just as complicated and as hard to handle as any drop-forge die in ordinary use. While some were plain, others were very complicated, some of them being 26 inches long with the entire face hard.

While our die-hardener was on the road he was also looking for a way that he could keep his die straight on all sides. This he finally accomplished, but the loss was so great that he had to drop that system, giving up this idea altogether as it would be working against the nature of steel.

His next step was to get the bulge on the bottom, that is, to be able to get it there every time. When he had finally gotten this, he was confronted with the proposition of getting it on the sides. Thus it brought him to the point where he could contract the die perfectly. After accomplishing this, he was up against hardening dies in lots of 30 to 40 per day. This called for lots of swift work and he could give but little time to each die. So he began to note results.

More Losses in Winter-Time Than in Summer

It seems that everybody was trying to get their dies just so hot when they were dipped, regardless as to whether the water was at the freezing-point or moderately warm. He compared his record of the summer with that of the winter, and he saw at once that the winter months carried nearly three times the greater percentage of loss than the summer. So he at once concluded it was either due to the dark days of winter or the extremely cold water.

Winter being over he could not test his heats to find the weak point, so he concluded to place a steam-pipe in the supply tank, never allowing the water to get below 80 degrees Fahrenheit. The results have been that winter and summer having come and gone, he has hardened 2,186 dies without a single loss. The full details for his hardening process for a drop-die follows:

To handle it with absolute safety, there must be a furnace that will heat so evenly that a 250-pound die and one weighing 16 pounds can be heated side by side, both coming to the

hardening-heat at the same time. As to the proper hardening-heat I would prefer to leave that to the hardener, but for fear of being told that I did not name the heat I will say that if you have steel that runs in carbon from 60 to 75 points, heat to a dull cherry-red; but if you have steel that runs from 75 to 90 points, then heat to a little more than somber red. Allow the dies about $2\frac{3}{4}$ hours to heat.

Temperature of Cooling Water

After you have the fire so you can heat the dies as described, the next step to get right on is the temperature of the water to be used in the cooling. There are many ways of doing this and much depends on the amount of the pressure of both the water and steam as to where the steam should be applied. Should the steam-pressure exceed the water-pressure, place the steam ahead of the water-valves on the hardening-tank. This will give complete control of the temperature of the water, and in fact be better than having it go directly to the supply-tank. The next move is to have the water in the cooling-tank so that it is absolutely under control, or so you can have your die in $\frac{1}{2}$ inch or 2 inches of water, just as the shape of the die will call for. This can be accomplished in several different ways. The best tank ever built was one with a 4-inch waste-pipe directly in the bottom of the tank, with a valve below and outside of the tank, under the ground line, with an extension-handle or wheel, where it could be reached while handling the die, thus regulating the depth of the water for cooling by the valve of the 4-inch waste-pipe. Where water would do damage in case of the tank overflowing, there should also be an overflow waste-pipe, thus confining the water entirely to the tank.

Have Plenty of Supply-Pipes for Water

Where three or four 400-pound dies are to be hardened daily, there should be several supply-pipes with not less than 30 pounds pressure from a $\frac{3}{4}$ -inch pipe, entering the tank at a place on the side or end where it can run to the bottom and

center of the tank, then up and directly under and within 6 inches of where the face of the die will rest when hardening. In some cases it will require more than one stream of water on a die, this of course depending on the outline of the face of the die. There are other things to consider, even before the die is heated.

Should the die have a hole for a plug or pin, these holes should be closed with iron pins turned to fit the hole, allowing always for shrinkage, which should not be less than $\frac{1}{16}$ inch where the hole is large, being sure to have them so they cannot drop out. Riveting is best where possible. Then thread one end of the plug, and put a nut on and tighten the same as a bolt. I know some will say, use fire-clay or putty. Fire-clay is not safe; putty is calcium carbonate, and when the work is heated with putty in the holes the calcium carbonate becomes just like any lime, ready to heat the moment water strikes it, consequently it is not safe.

Hardening the Die

After it is heated ready to harden, take, say, the 16-pound die from the fire, and place in from one to two inches of water face up. Let it stay until the back gets moderately black or cooled just enough, so that when the die is turned the back can be cooled as quickly as the face. Before turning it on the face over the stream of water to harden, take a piece of coarse cloth, wrapped firmly on a handle, so as to make a swab. Have this in water at all times. Take the swab or wipe-stick from the water, wipe the face and high points of the die so as to drive any excessive heat from them, being sure not to use it so freely as to prevent hardening. Then place the die over the stream face down, cool the back slowly by letting the water on and off the back, thus allowing the heat to be driven out the back rather than the face or sides.

The depth the face of the die should be in the water depends on the outline of the working-face, but not more than $\frac{3}{4}$ inch on a die that has a moderately straight face. When the die becomes black on all sides, shut off the water and re-

move to a place in the tank where it can be placed in the water face down and just sufficient water to cover the impressions, providing they are one inch deep. The die should sit in at least one inch of water, regardless of the shallowness of its impression, after being taken from the stream, but do not continue the stream after the die is black. Leave it in the still water until thoroughly cool, then draw the temper.

Drawing the Temper

There are many ways of tempering them, but this should be done in a furnace constructed for that purpose, never placing the dies to be drawn in a fire with more than 215 degrees Centigrade (420 Fahrenheit), allowing them to take the temper slowly. Then let cool. In the hardening of the 250-pound die, take it from the fire, keeping the face up, and place in the water within three or four inches of the face. Leave there until the back or shank gets moderately black. Take from the water, wipe the high places with the wet swab and turn the die over the stream of water to harden, being sure the temperature of the water is not below 80 degrees Fahrenheit. If there is more than one impression use more than one stream of water, so that the water will strike all parts of the die that are to be hardened. The die should not sit in more than $\frac{3}{4}$ inch of water when hardening, unless the impressions go deeper than this. Even if they do and are on the inside and center of the face, the force of the water will be sufficient to harden that part. The idea is not to have the die in deep water while hardening, and by cooling the back slowly while hardening the face, the die can be held straight and hardened without any danger of losing it.

After the die has become black on the sides and ends, then stop cooling the back, turn off a part of the water and let the die sit over the gently flowing stream until cool. This rule applies to all dies of 100 pounds or over, while the smaller dies can be placed to one side, away from the stream in one inch of water to finish cooling. Be careful not to take the dies of any size out of the water before they are thoroughly cool. A

die weighing 250 pounds should not be cooled in less than 1½ hours.

Cool the Die Thoroughly

In examining the die for heat, the back or shank of the die should be entirely dry. Place the palm of the hand, or better still the arm, on the die, to feel for the heat, and as long as there is any heat that can be felt with the arm, do not remove the die; *let it stay in the water until the heat is entirely out. This is the most dangerous point*, and if well guarded it can be passed without the loss of one; even should there be a flaw in the die, it will stand the hardening.

The tempering of the die is also of great importance. The tempering fire should not be more than 215 degrees Centigrade, as before stated. When the die is in place to be drawn, and where there is no way of telling just what the heat is, the safe way is to cover the face of the die with a cold piece of iron. This will prevent the heat striking the corners until the body begins to warm. After the water is driven entirely from the face by the heat under the iron on the face of the die, then the iron can be removed and the die allowed to come to the desired temper. After this the die should be allowed to cool in the open air.

INDEX

- Accuracy of outline, testing with lead proofs, 19
Accurate forgings, 135
Advantages of oil fuel, 146
Air-brake, Westinghouse, 287
Air-power hammer, 209
Ajax forging-machine, drop-forging, 265
Alabama Polytechnic Institute, 186
Alloying materials, effects of, 136
Aluminum in steel, 137
Ambler drop-hammer description, 176
Ambler drop-hammer, front view of, 173
side view of, 173
Ambler, Mr. A. A., 176
American machinery, introduction of, 163
American Machinist, article on iron strains, 187
American tool-steel, samples worked upon, 189
Annealing furnaces, Brown & Sharpe heating and, 26
Anvil block, improved, 200
Appliances, hardening, 83
Armstrong boring-tool dies, 40
Art, growth of drop-forging and stamping, 50
Assembling flanges and spokes with hubs, 216
Assembling wheelbarrow wheel, 204
Author, visiting O. K. Tool Holder Plant, 318
Autogenous welding, 136
applications of, 299
conclusions on, 302
Automobile shop drop-forging practice, 11
Axle in three stages, forged, 120
Badge, embossed, 65
Baldwin Locomotive Works, first steam hammer in, 184
Ball-vise, special, used in die-sinking, 15
Barnum & Richardson car-wheel iron, 78
Bates Forge Company, 124
Bell-crank, die for forming the end of, 51
Belt punch, 126
Bement, Miles & Co. steam-hammers, 184
Bending-die for steering-gear part, 23
Bending-dies for connecting-rod straps, 279
Bending eye-bolts in bulldozer, 284, 285
Bending-form in front, drop-forging die showing, 22
Bending-machine, working in drop and, 198
Bethlehem Steel Company, 248
Billings & Spencer Company, Hartford, Conn., 181
Black and M. F. Kahm, Messrs. J. S., 187
Blacksmith, first "interchangeable," 166
Blanchard, Thomas, in 1727, 247
Blanks, trimming wrench, 124
Blast-forge refitted for oil-fuel, 145
Block, improved anvil, 200, 201
Board fastening of hammer, 169
Board in hammer, method of fastening, 168
Board, steam, helve, trip, and drop hammers, 140
Bolster for postal and baggage cars, 264
Bolt-heading dies, 100
Bosser levers, dies for finishing, 46
Bradley hammer, 284
Bradly cushion hammers, 179
Brazing furnaces, 161
Breaking-down die, example of, 21
Breaking-down and finishing-dies, 122
Breaking-down dies, edging and flattening, 22
Breaking-out, using the chisel, 73
Breaking-through chisels, 70
Bridgeport, Conn., Geo. F. Champney, 75
Bridgeport Patent Die Company, 79

- Brine tank, 143
special, 144
- Brown & Sharpe case-hardening furnace for fuel oil, 143, 149
- Brown & Sharpe furnaces, 26
- Brown & Sharpe heating and annealing furnaces, 26
- Bucket, design of elevator, 260
- Bucket dies, molding elevator, 261
- Buckets, making elevator with steam-hammer, 257
- Built-up die, 304
- Built-up or welded-up die work, 302
- Bullard, E. P., of Bridgeport, 76
- Bulldozer appurtenances, 241, 242
- Bulldozer, bending eye-bolts in, 284, 285
work of the forming-machine and, 266, 267
- Burdick hot-pressed nut-machine, 254
- Burners, for oil fuel, 160
- Cars, bolster for postal and baggage, 264
- Casting, and dropping drop-dies, modeling, 77
- Cast-iron die-holder, 28
- Cast-iron dies, wooden patterns for pair of heavy, 40
- Cavities, typing tools used to form, 18
- Chain, details of new short stiff link, 229
dies for forming, 230
former method of making, 235
methods of manufacturing welded, 234
present method of making welded, 236
- Chain-making, die for, 240
process of welding in, 240
screw-press for, 231
the link-cutter, 238
the link-winder in, 236, 237
welding hammer in, 239
welding machine in, 238
- Chains, dies for welding, 230
early history of, 227
new method of making weld-less, 228
- Champney die-sinking process, 74
- Champney, George F., 75
- Champney in Europe, 76
- Champney process, final development of, 85
- Champney shop, die-sinkers in, 80
specimen of work done in, 81
- Charcoal iron, samples of good, 191
- Checkering and grooving vise jaws, tools for, 132
- Chisel, using the breaking-out, 73
- Chisels, breaking through, 70
- Chromium in steel, 136
- Clipper steel, 121
die of, 121
- Closed and open dies for forgings, 88
- Coal-forges and furnaces for fuel oil, refitted, 148
- Colt, Colonel Samuel, 164
- Combination dies, 94
- Combination tool-holders and their use, 312
- Compound lever device for head lifting, 165
- Conclusions on welding, 302
- Connecticut, The O. K. Tool Holder Company, Shelton, 312
- Connecting-rod straps, bending dies for, 279
- Connecting-rods, forging dies for, 277
machining inside surface of, 281
planing ends of, 280
- Construction details of drop-hammer, 176, 177
- Construction, jointed swinghead, 165
of drop-hammer, 167
- Cost of forgings, 282
- Counterbalanced treadle, 164
- Crane hook, die for, 54
- Crank, die for forging, 59
- Crowbar for locomotive boilers, 265
- Cutters for nicking stock, 59
- Cutting the impression in die-sinking, 67
- Cylinder, welding top of, 301
- Davy Brothers, Sheffield, England, 249
- Deep-forming die, machining a, 43
- Department, layout of hardening, 142
location of die-sinking, 140
- Development of the drop-hammer, 163
- Die assembled, die-holder and, 28
- Die-block, planing a, 12
- Die-blocks and impression-blocks, 96
- Die, built up, 304
cool the, thoroughly, 329
drawing the temper in drop, 328
driving model into the, 79
example of breaking-down, 21
finishing on profiling machine, 14

- Die, finished with high-speed cutting tool, 313
 for chain-making, 240
 for forging-crank, 59
 for forming end of bell-crank, 51
 for forging hole through a boss, construction of, 57
 for second operation on ratchet drill handle, 36
 for turning eye-bolts, 283
- Die-hardening, piping for drop, 306
 supply pipes for drop, 326
 temperature of water in drop, 326
- Die, hardening the drop, 327
- Die-holder and die assembled, 23
- Die-holder, cast-iron, 28
- Die, holes punched by punches integral with, 56
 machining a deep forming, 43
- Die-making, method of, 45
- Die, method of making drop-forging, 29
- Die-practise for accurate forging, 27
- Die, setting the, 135
- Die-sinkers in the Champney shop, 80
- Die-sinking, a few milling tools used in, 17
 cutting the impression in, 67
 fly-cutters used in, 17
 profiling machine used in, 13
 typing tools used in, 18
- Die-sinking and embossing practise, 62
- Die-sinking and shop-practise in cutting tool-holder forging, 37
- Die-sinking department, location of, 140
- Die-sinking for butt-plate of military rifle, 30
- Die-sinking history, 7
- Die-sinking machines, 86
- Die-sinking methods, processes, and machines, 62
 process of, 9
- Die-sinking process, the Champney, 74
- Die, steel blank for, 28
- Die-steel, high class not used, 42
 made by Farist in Bridgeport, Conn., 81
- Die to resist wear, making, 97
- Die-work, built-up or welded-up, 302
- Dies and header for forging swing-hanger, 268
- Dies and the drop, the, 196
- Dies, bolt-heading, 100
 breaking-down and finishing, 122
 combination, 94
 drop-forging, 94
 drop-forgings as they appear from, 38
 economy of drop-forging dies, 197
 exactness of size of, 84
 examples of drop-forging, 21
 facilities for reproduction of drop, 194
 finishing the hammer dies, 106
 first principles in holding, 99
 for Armstrong boring-tools, 40
 for connecting-rod straps, bending, 279
 for crane hook, 54
 for finishing bossed levers, 46
 for finishing eye-bolt, 50
 for first operation on ratchet drill handle, 36
 for forging an eye-bolt, 50
 for forming chain, 230
 for lever with hubs on both ends, 49
 for making flat-ware, 323
 for pin-ends, forging, 112
 or trimming hand-vise forgings, punches and, 131
 for welding chains, 230
 forge where heated, 78
 forging machine, 269
 forging-press for making hammers, 104
 hardening drop-dies, losses in, 325
 hardening drop-forging, 26
 heating and hardening of, 82
 in drop-presses, holding, 322
 keying wide-seat, 98
 making and working out, 60
 materials used for, 50
 method of applying pressure or impact in, 56
 method of fastening hammer, 179
 methods used for making, 59
 molding elevator bucket, 261
 needed for forging-press, few, 108
 pony, 39
 provided with space for receiving fin, 50, 51
 punching small holes through work in, 56
 sectional, 46
 sectional drop-forge, 48
 spoiling, 195

- Dies, staking tools used for repairing, 20
 tack-making, and their action, 245
 tack and tack, 244
 tongs for holding, 60¹
 tools employed in making drop, 16
 trimming, 24
 use of, in drop-hammer, 94
 use of, in drop-press, 94
 use of, in forging-machine, 94
 without loss, hardening drop, 324
 working stock in drop, 193
- Drill handle, drop-forging a ratchet, 34
 expanding the shell of, 36
- Drilling out the stock, 72
- Driving model into the die, 79
- Drop and bending-machine, working in, 198
- Drop and hydraulic forged cutting-tools, 309
- Drop, the dies and the, 196
- Drop-die, drawing the temper, 328
 hardening, cool the die thoroughly, 329
 hardening, losses in, 325
 hardening the, 327
 piping for, 306
 supply pipes for, 326
 temperature of cooling water, 326
- Drop-dies, combination, 94
 facilities for reproducing, 194
 hardening of various steels, 304
 working stock in, 193
- Drop-forge and hardening plant, 139
 plan of modern, 141
 under one roof, 139
- Drop-forge die, making a, 13
 method of sinking a, 29
- Drop-forge dies for ship-fittings, 43
- Drop-forge work, 11
- Drop-forged, lead-proofs of various parts to be, 39
- Drop-forged shell and handle for ratchet drill, 34
- Drop-forged ship-fittings, 42
- Drop-forging, example of breaking-down die in, 21
 analogous, hot stamping and, 53
 and stamping art, growth of, 50
 and stamping large parts, principles of, 51
 a ratchet drill handle, 34
 die and bending die for steering gear part, 23
- Drop-forging, die for wrench and trimming-die for same, 24
 die, hardening the face of, 27
 die, showing bending form in front, 22
 die, with edging and breaking-down dies, 22
 die work, 8
 for the Ajax forging-machine, 265
 on the Pacific Coast, 41
 or squeezing, 134
 practise, automobile shop, 11
 removal of fin produced in, 54
 unusual job of, 120
- Drop-forging dies, 21, 94
 examples of, 25
 for gun work, 118
 hardening, 26
 materials for, and life of, 11
 samples of lead proofs, 19
 special ball-vice used in sinking, 15
- Drop-forging dies and work, 12
- Drop-forgings, as they appear from dies, 38
 cost of, 136
 making of, 7
- Drop-hammer, at International Harvester Company, 178
 construction, 167
 details of construction, 175
 development of, 163
 effects, 174
 effects, Miner & Peck Mfg. Co., 174
 first United States patent of, 104
 forgings, 134
 for heavy work, 180
 for sinking-dies, 79
 foundations, 170
 foundations, Portland cement for, 170
 Golding & Cheney patent of, 164
 improved and up-to-date, 181
 Pratt & Whitney Co., 170
 sectional view of, 167
 use of dies in, 94
- Drop hammers, board, steam, helve, trip, and, 140
 of Billings & Spencer Company, 181
 oil-heating furnaces and, 25
- Drop-press, for flat-ware operations, 321
 use of dies in, 94
- Drop-presses holding dies in, 322
- Drop-rod, 174
- Drop-work, flash in, 35
 location of fin in, 54

- Dropping drop-dies, modeling, casting and, 77
 Drops on stock, effect of, 198
 Ductility lost at 600 degrees F., 138
 Dusseldorf Exposition, ten thousand-ton hydraulic press at, 291
 Eberhardt, Messrs. Ulrich and Fred. L., 214
 Economy in use, tool-welding, 314
 Edging and flattening breaking-down dies, 22
 Effects of alloying materials, 136
 Electric welding, 136
 Elevator bucket, design of, 260
 Elevator buckets with steam-hammer, making, 257
 Embossed badge, 65
 Embossed number plate, 66
 Embossed ornament in sheet-metal, 67
 Embossed police-shield, 65
 Embossed stamping, 68
 Embossed work, making forces for, 62
 End-heating forge furnace, 155
 Enfield rifle for English Government, 163
 Engine connecting-rod forging, 276
 England in 1634, chain patents in, 228
 English Government, Enfield rifle for, 163
 Essegny, Stefan Kiss v., 229
 Evolution of the process, history of Champney, 75
 Exactness of size of dies, 84
 Examples of drop-forging dies, 21
 Examples of hydraulic forging production, 296
 Expanding the shell of drill-handle, 36
 Experiments, materials used in steel and iron, 186
 practical results of twisting, 197
 Eye-bolt, dies for finishing, 50
 dies for forging, 50
 Eye-bolts, die for turning, 283
 Farist in Bridgeport, die-steel made by, 81
 Files, rifflers, etc., used by die-sinkers, 16
 Fin, dies provided with space for receiving, 50, 51
 location of, in drop-work, 54
 removal of, in drop-forging, 54
 stripping die for removing, 52
 Final development of Champney process, 85
 Flange forming tools, 214
 Flanges, heating, 212
 making the, 209
 punching eight rivet holes in, 215
 wheels ready for spokes and, 211
 Flanging holes in work, 55
 Flash in drop work, 35
 Flat-ware, dies for making, 323
 drop-press, foundations for, 321
 operations, drop-press for, 321
 treatment and use of dies in, 323
 Flat-work, steel forces for, 64
 Fly-cutters used in die-sinking, 17
 Foss Manufacturing Co., Springfield, Ohio, 176
 Force holder, 69
 Force-making, process of, 10
 Forces, different shaped, 63
 for embossed work, making, 62
 properly made, 62
 steel for flat-work, 64
 Forge, for center-heating, double opening, 152, 153
 for end heating, single opening, 151
 furnace, adjustable top-slot oil, 154
 furnace, end heating, 155
 furnace, tool-dressing, 157
 furnaces, single and double opening, 156
 shop, slab-truck for, 127, 128
 where dies were heated, 78
 Forged axle in three stages, 120
 Forges and heaters, oil burning, 154
 Forges, installation of, 158
 top slot and end-heating, 157
 Forging, drop-hammer, 134
 engine connecting-rod, 276
 fin into the bar by rotating, 53
 high-grade steels, 136
 hydraulic, 293
 in dies from the bar stock, 51
 in the heavy swaging-machine, 262
 large pieces, 133
 machine, 275
 shapes produced by hydraulic, 297
 straight peen hammers, 286
 swing-hanger, dies for, 268
 the high-speed steel cutting points, 317
 under steam-hammer, 133
 unusual job of drop, 120
 with dies in a railroad shop, 284
 without special tools, 291
 with special tools and unskilled labor, 287

- Forging a fork-lever, 55
 Forging a fulcrum bracket, set of tools for, 110
 Forging and flanging man-hole seatings, die for, 58
 Forging die, for steering-gear part, 23
 forming center holes in bosses, 49
 hob for, 92
 practise for accurate, 26
 Forging dies, for connecting-rods, 277
 for pin ends, 112
 for round and square upsetting, 116
 vanadium, 36
 Forging-machine, drop-forging for, 265
 large hydraulic, 256
 multi-cylinder hydraulic, 253
 Forging-machine dies, 269
 Forging-machines, use of dies in, 94
 Forging practise, 294, 295
 examples of hydraulic, 296
 Forging-press, rapid-action, 247
 few dies needed for, 108
 Forging round work to destroy fin, 53
 Forging-shop, time-card for the, 288, 289
 Forgings, accurate, 135
 accuracy of, 8
 and their making, micrometrical, 32
 closed and open dies for, 88
 cost of, 282
 inferior quality of, 137
 locomotive, made in hydraulic machine, 258, 259
 micrometrical, 31
 planing tools for, 129
 proper practise for hydraulic, 298
 wrought-iron for small, 54
 Forming-machine and bulldozer, work of, 266, 267
 Foundations, drop-hammer, 170, 171, 172
 for flat-ware drop-presses, 321
 ratio of base compared with weight of hammer, 169
 Fuel, advantages of oil, 146
 Fuel for preheating, 301
 used in tests on steel, 190
 Fuel-oil refitted forges and furnaces for, 148
 Fulcrum bracket, set of tools for forging, 110
 Furnace, end-heating forge, 155
 refitted lead-pot for oil fuel, 146
 tool-dressing forge, 157
 tube-brazing, 159
 wire-brazing, 158
 Furnaces, brazing, 161
 for fuel-oil, refitted forges and, 148
 heating, 26
 Gas-fired ladle heater, 160, 161
 Gas-heating flanges in muffle, using natural, 212
 Gears, pressed steel, 214
 Golding & Cheney patent of drop-hammer, 164
 Grooving vise jaws, tools for checking and, 132
 Gun-work drop-forging dies, 118
 Hammer, air power, 209
 board fastening, 169
 Bradley, 284
 emergency steam, 270
 for heavy work, drop, 180
 making a double-faced, 106
 method of fastening board in, 168
 weight of base compared with foundations, 169
 Hammer-blows, die-work done with, 56
 Hammer-dies, 179
 finishing the, 106
 method of fastening, 179
 Hammer-heads, method of securing, 178
 Hammers, board, steam, helve, trip, and drop, 140
 Bradley cushion, 179
 forging-press dies for making, 104
 forging straight peen, 286
 steam, and capacity, 182
 Hand-vise forgings, punches, and dies for trimming, 131
 with shavings, 130
 work on, 130
 Hand-vise handle before and after closing, 129
 Hanger, passenger-car truck-swing, 263
 Hardening appliances, 83
 Hardening, cool the die thoroughly in, 329
 heating of dies and, 82
 piping for drop-die, 306
 Hardening department, layout of, 142

- Hardening drop-dies, of various steels, general practise, 304
 losses in, 325
 without loss, 324
- Hardening drop-forging dies, 26
- Hardening-plant, drop-forge and, 139
 plan of modern drop-forge and, 141
 under one roof, drop-forge and, 139
- Hardening the drop-die, 327
- Hardening the face of drop-forging die, 27
- Heads, method of securing hammer, 178
- Heaters, 162
 oil-burning forges and, 154
- Heating and annealing furnaces, Brown & Sharpe, 26
- Heating and hardening of dies, 82
- Heating, flanges, 212
 furnaces, 26
 metal before welding, 300
 too suddenly, 138
- Helve, board, steam, trip, and drop hammers, 140
- High-class die-steel not used, 42
- High-grade steels, forging, 136
- High-speed cutter and chip, 319
- High-speed cutting points, forging the, 317
- High-speed cutting tool, shanking die with, 311
- High-speed cutting tools and holders, 314
- High-speed steel, 309
 and tool-holders, 310
 hydraulic forging cutter, 320
- History and evolution of the process, 75
- History, of chains, early, 227
 of die-sinking, 7
- Hob for forging dies, 92
- Holder, force, 69
- Holes punched by punches integral with die, 56
- Horse-power, steam-hammers, 184
- Hot-pressed nut-machine, 254
- Hot-stamping and drop-forging analogous, 53
- Howard Iron Works, Buffalo, N. Y., 254
- Hubbing, typing or, process, 60
- Hubs and flanges, wheels ready for, 211
- Hydraulic forged cutting-tools, drop and, 309
- Hydraulic forging, 293
- Hydraulic forging-die, for first operation, 318
 for high-speed, 320
- Hydraulic forging-dies, 61
- Hydraulic forging-machine, large, 256
 multi-cylinder, 253
- Hydraulic forging-press, rapid action, 247
- Hydraulic forging production, examples of, 296
- Hydraulic forging, proper practise for, 298
 shapes produced by, 297
- Hydraulic forging-punches, shaping of, 298
- Hydraulic machine, locomotive forging, made in, 258, 259
- Hydraulic press, description of, 294
 gives best results, 137
 pressure for small work in, 252
 ten thousand-ton, 290
 tremendous pressure of, 248
- Impression-blocks, die-blocks and, 96
- Indianapolis, Bates Forge Co., of, 124
- Installation of forges, 158
- Interchangeable blacksmith, the first, 166
- International Harvester Co., hammers at, 178
- Internationale Handelsgesellschaft, Kleineberg & Co., 234
- Inventor, Mr. F. B. Miles, of a steam-hammer, 184
- Iron, practical effects of working, 198
 samples of coal-stone worked upon, 192
 samples of good charcoal, 191
 shear for cutting off, 272
 under different degrees of heat, steel and, 186
- Jeffery shop, die-sinkers in, 18
- Jeffery & Co., Thomas B., Kenosha, Wis., 11
- Jessops steel, samples worked upon, 188
- Jointed swinghead construction, 165
- Judgment, what is good, 309
- Justice-hammer, welding wagon wheel rims with, 208
- Kahm, Messrs. J. S. Black and M. F., 187
- Keying wide-seat dies, 98

- Ladle-heater, gas-fired, 160
 Layout of hardening department, 142
 Lead-casting as proof of die, 20
 Lead-castings, samples of proofs of dies, 19
 Lead-pot furnace refitted for oil fuel, 146
 Lead-proofs of various parts to be forged, 39
 Lehigh Valley Railroad Company, 284
 Link-cutter in chain-making, 238
 Link-winder in chain-making, 236, 237
 Location of die-sinking department, 140
 Locomotive boilers, crowbar for, 265
 Locomotive forging made in hydraulic machine, 258, 259
 London, rifles assembled at Tower of, 163
- Machine, hot-pressed nut, 254, 255
 job for the heavy, 260
 Machine-dies, forging, 269
 Machine-forging, 275
 Machinery, value of modern, 89
 Machinery-steel, samples worked upon, 190
 Machines, die-sinking, 86
 Machining inside surface of connecting-rods, 281
Machinist, American, article on steel, 187
 Making a double-faced hammer, 106
 Making a drop-forging die, 13
 Malleable iron parts, 7
 Manganese in steel, 137
 Man-hole seatings, die for forging and flanging, 58
 Manufacturing connecting-rods for steam-engines, 277
 Mare Island navy yard, 41
 Materials, effects of alloying, 136
 used for dies, 50
 used in steel and iron experiments, 186
 Metal parts, union between, 95
 Metal wheels, how made, 215
 details of, 221
 Method of installing apparatus for oil fuel, 156
 Micrometer, inside, 19
 Micrometrical forgings, 31
 Miles, first hammer made by Mr., 185
 Miles, Mr. F. B., a steam-hammer inventor, 184
 Military rifle, die-sinking for butt plate of, 30
- Milling-rod ends, 278
 Milling sides of rods, 278
 Milling-tools used in die-sinking, 17
 Miner & Peck Mfg. Co., drop-hammer effects, 174
 Modeling, casting, and dropping drop-dies, 77
 Models, plaster-of-Paris, 38
 Modern drop-forge and hardening-plant, plan of, 141
 Modern machinery, value of, 89
 Molding elevator bucket dies, 260
 Moline tire-bender, 205
 Movements, saving unnecessary, 104
 Multicylinder hydraulic forging-machine, 253
- Natural gas tire-welding, 207
 Natural gas, using for heating, 212
 New England States, drop-hammer men in, 99
 New Zealand railways, 287
 Nickel in steel, 137
 Niles-Bement-Pond Co., 185
 Norway iron samples worked upon, 193
 Number plate, embossed, 66
 Nut-machine, hot-pressed, 254
- Oil-burning forges and heaters, 154
 Oil fuel, advantages of, 146
 burners for, 160
 refitted blast-forge for, 145
 refitted lead-pot furnace for, 146
 Oil-heating furnaces and drop-hammers, 25
 O. K. Steel made in Sheffield, England, the best, 318
 O. K. Tool Holder Company, Shelton, Conn., 312
 O. K. Tool-holder plant visited by author, 318
 O. K. tools and holder, set of, 316
 Open dies for forgings, closed and, 88
- Pacific Coast, drop-forging on the, 41
 Paper pulleys, 166
 Passenger-car truck swing-hanger, 263
 Patent Die Company, 76
 Pennsylvania Railroad, 256
 Pin ends, forging-dies for, 112
 Piping, arrangements of, 50
 Piping for drop-die hardening, 306
 Plan of modern drop-forge and hardening-plant, 141

- Plan of belt-punch die, 126
 Planing a die-block, 12
 Planing ends of connecting-rods, 280
 Planing tools for finishing forgings, 129
 Plant, drop-forge and hardening, 139
 plan of modern drop-forge and hardening, 141
 Plaster-of-Paris models, 38
 Police shield, embossed, 65
 Portland cement for drop-hammer foundations, 170
 Practise for hydraulic-forgings, 298
 Pratt & Whitney Company drop-hammer foundations, 179
 Preheating, fuel for, 301
 Press and tools, spoke-forming, 209
 Press, description of hydraulic, 294
 dies, forging for hammers, 104
 gives best results, hydraulic, 137
 pressure for small work in hydraulic, 252
 rapid-action hydraulic forging, 247, 249, 250
 ten thousand-ton hydraulic, 290
 tremendous pressure of hydraulic, 248
 wheel-flange, muffle, and forming, 213
 Pressed steel gear blank, 218
 Pressed steel gears, 214
 Presses, foundations for flat-ware, 321
 Pressure for small work in hydraulic press, 252
 Pressure in dies, method of applying impact or, 56
 Pressure of hydraulic forging-press, tremendous, 248
 Prevision and supervision, 91
 Principles in holding dies, first, 99
 Principles of drop-forging and stamping large parts, 51
 Process of welding in chain-making, 240
 Process, typing or hubbing, 60
 Profiler, working dies in the, 39
 Profiling machine, finishing-die on, 14
 Proof, the lead-casting as proof of die, 20
 Pulleys, paper, 166
 Punch, belt, 126
 Punches and dies for trimming hand-vise forgings, 131
 Punches, shaping of hydraulic, 298
 Punching eight rivet-holes in flanges, 215
 Punching holes, semi, 57
 through bosses, 56
 Punching small holes in work in dies, 56
 Railroad shop, forging with dies in, 284
 Ratchet drill-handle, drop-forging a, 34
 first operation on, 35
 second operation on, 36
 Reed, Ezekiel, 1786 and 1798, 247
 Refitted blast-forge for oil fuel, 145
 Refitted coal forges and furnaces for fuel-oil, 148
 Refitted lead-pot furnace for oil fuel, 146
 Repairing dies, staking dies used for, 20
 Riffles and their use, 71
 Riffers, files, etc., used by die-sinkers, 16
 Rim and spokes as machined, 225
 Rim-bending rolls for wheels, 205
 Riveting-press, ready to go on the, 217
 Riveting-spokes in wheels, 210
 Rock drill used as a steam-hammer, 271
 Roughing tools, 74
 Round and square upsetting, forging-dies for, 116
 Rubens, head of, 82
 Sacramento, California, railroad shops at, 270
 Scrapers, files, riffers, etc., used by die-sinkers, 16
 Screw-press for chain-making, 231
 Section of wheel-rim, enlarged, 226
 Section view of drop-hammer, 167
 Sectional dies, 46
 Sectional drop-forge dies, 48
 Semi-punching holes, 57
 Setting the die, 135
 Shanking dies with high-speed cutting-tool, 311
 Shapes produced by hydraulic forging, 297
 Shaping of forging-punches, hydraulic, 298
 Shear for cutting off iron, 272
 Shelton, Conn., The O. K. Tool Holder Co. at, 312
 Sheffield, England, O. K. Steel best made in, 318
 Ship-fittings, drop-forge dies for, 43
 drop-forged, 42
 Silicon in steel, 137

- Single and double opening forge-furnaces, 156
- Sinking-dies, drop-hammer for, 79
- Slab truck for forge-shop, 127
- Smith-working at the anvil, 52
- Spaulding, Mr. B. F., 187
- Special brine-tank, 144
- Specimen of work done in Champney shop, 81
- Spoiling dies, 195
- Spoke-forming press and tools, 209
- Spokes and rim, assembling flanges and hub with, 216
- Spokes, punching holes for wheel-spokes, 224
- Spring-clamp for wheel-spokes, 227
- Square upsetting, forging dies for round and, 116
- Squeezing, drop-forging or, 134
- Staking-tools used for repairing dies, 20
- Stamped forgings, 58
- Stamping'art, growth of drop-forging and, 50
- Stamping, embossed, 68
- Steam, helve, trip, and drop hammers, 140
- Steam-engines, manufacturing connecting-rods for, 277
- Steam-hammer, 4,000-pound, 122
and size of work, capacity of, 182
Bement, Miles & Co., 184
capacity of, 184
emergency, 270
forging under, 133
in Baldwin Locomotive Works, first, 184
making elevator buckets with, 257
rock-drill use as, 271
- Steam-hammers, horse-power, 184
- Steel, aluminum in, 137
and iron under different degrees of heat, 186
and wrought iron, difference in treatment of, 54
blank for die, 28
chromium in, 136
clipper, 121
cutting points, forging the high-speed, 317
die-holder, etc., 28
fuel used in tests on, 190
gear blanks, pressed, 218, 219, 220
high-speed, 309
manganese in, 137
nickel in, 137
tests, 195
- Steel, samples of American worked upon, 189
samples of Jessops worked upon, 188
samples of machinery worked upon, 190
silicon in, 137
titanium in, 137
tungsten in, 137
wheels, 224
- Steels, forging high-grade, 136
hardening drop-dies of various, 304
vanadium, 137
- Steering-gear part, drop-forging and bending-die for, 23
- Stock, drilling out the, 72
for forging ratchet drill-handle, 34
- Stone coal-iron, samples worked upon, 190
- Stripping die for removing fin and its work, 52
- Supervision, value of prevision and, 91
- Swaging-machine, job for, 260
- Tack and tack-dies, 244
- Tack-dies, tack and, 244
- Tack-making tools, complete set of, 246
and their action, 245
- Tank, brine, 143
special brine, 144
- Temper, drawing the, in drop-dies, 328
- Tension test, results of, 194
- Ten-thousand-ton hydraulic press, 290, 291
- Tests, on steel, fuel used in, 190
results of tension, 194
wrought-iron and machinery steel, 195
- Time-card for the forging-shop, 288, 289
- Tire-bender, Moline, 205
- Titanium in steel, 137
- Tongs for holding dies, 60
- Tool-dressing forge furnace, 157
- Tool-holder making, drop-forging practise in, 37
- Tool-holders and their use, combination, 312
- Tool-holders, high-speed steel and, 310
- Tool-steel, samples of American, worked upon, 189
- Tools, complete set of tack-making, 246
employed in making drop-dies, 16

- Tools, flange forming, 214
 for checkering and grooving
 vise-jaws, 132
 for forging a fulcrum bracket,
 set of, 110
 forging without special, 291
 roughing, 74
- Tower of London, rifles assembled
 at, 163
- Treadle, counterbalanced, 164
- Treatment of steel and wrought-
 iron, difference in, 54
- Trimming, hand-vise forgings,
 punches, and dies for, 131
 wrench after, 125
 wrench before, 125
 wrench blanks, 124
- Trimming-die, finished with high-
 speed cutting-tools, 315
 for belt-punch, 126, 127
- Trimming-dies, 24
- Trip-hammers, board, steam, helve,
 and drop, 140
- Tube and flange, welding, 301
- Tube, brazing furnace, 159
- Tungsten in steel, 137
- Twisting experiments, practical re-
 sults of, 191
- Typing or hubbing process, 60
- Typing tools used in die-sinking, 18
- Ulrich and Fred L. Eberhardt,
 Messrs., 214
- Union between metal parts, 95
- United States patent of drop-ham-
 mer, first, 164
- Upsetting, forging-dies for round
 and square, 116
 round to square, 118
- Using the breaking-out chisel, 73
- Value of modern machinery, 89
- Vanadium forging-dies, 36
- Vanadium steels, 137
- Vermont, development of drop-ham-
 mers in State of, 163
- Vernier caliper depth-gage, 19
- Vise, before and after closing, hand,
 129
 hand, with shavings, 130
 hand, work on, 130
 jaws, tools for checkering and
 grooving, 132
- Water, temperature of cooling in
 drop-dies hardening, 36
- Wear, making a die to resist, 97
- Welded chain, methods of manufac-
 turing, 234
 present method of making, 23
- Welding, applications of autoge-
 nous, 299
 autogenous and electric, 136
 cast-iron muzzle and flange on
 cylinder, 302
 chains, dies for, 230
 hammer in chain-making, 239
 heating metal before, 300
 in chain-making, process of,
 240
 machine, in chain-making, 238
 tire, natural gas, 207
 top of cylinder, 301
 tube and flange, 301
- Weldless chains, new method of
 making, 228
- Westinghouse air-brake, 287
- Wheel construction, complete details
 of, 228
- Wheel, making a wheelbarrow, 203
 operations on wheelbarrow, 204
 rim and spokes as machined,
 225
 rim, section enlarged, 226
- Wheel-spokes, punching holes for,
 224
 spring-clamp for, 227
- Wheel tire-making, 218
- Wheelbarrow wheel, making a, 203
 operations on, 204
 parts ready for assembling, 204
- Wheel-flange, muffle and forming-
 press, 213
- Wheels, details of metal, 221
 how metal, are made, 215
 ready for hubs and flanges, 211
 ready to be riveted, 217
 rim-bending rolls for, 205-206
 riveting spokes in, 210
 steel, 224
 welding the rims on Justice
 hammer, 208
- Wide-seat dies, keying, 98
- Wilkinson, Jeremiah, 1775, 246
- Wire-brazing furnace, 158
- Wooden patterns for pair of heavy
 cast-iron dies, 40
- Worcester drop-hammer men, 99
- Worm-cutter and chip, high-speed
 steel, 319
- Wrench, after trimming, 125
 before trimming, 125
 blanks, trimming, 124
 drop-forging, etc., 24
- Wrought-iron and machinery steel
 tests, 195
- Wrought-iron, difference in treat-
 ment of steel and, 54
 for small forgings, 54
 tests, 195



Do you know
the comparative



values of various fuels? Have you
the most economical furnace equipment?

The question of fuel is one which to-day demands careful attention, and can only be determined after careful consideration of the nature of the work, base cost of fuel and the money investment. We are prepared to furnish figures showing relative economy of all fuels, taking into consideration direct firing, preheating and regeneration.

This table of comparative fuel values is copied from page 3 of our Catalog F-20:

KIND OF GAS	Heat units in 1 cu. ft.	Cu. feet to equal 1 gallon of oil
Natural Gas.....	1000	140
Coal Gas, 20 C.P.	675	208
Carburetted Water Gas.....	646	216
Gasoline Gas, 20 C.P.	690	202
Water Gas from Bituminous Coal..	377	376
Water Gas from Anthracite Coal..	313	447
Producer Gas.....	150	935
Producer Gas.....	90	1555
—1 pound average oil.....	equals 19,000 B. T. U.	

Rockwell Furnace Company

is at your service

Furnace building, Economical Furnace building, is our specialty. We can better your conditions. We employ a force of competent expert furnace engineers especially trained and are prepared to submit specifications and prices on complete furnace equipment, USING ANY FUEL, and guarantee the proper operation.

Rockwell Furnace Company

26 Cortlandt Street
New York

Fisher Building
Chicago

*If you have anything in my line,
put your time against mine and
consult me; if I help you I charge
a moderate fee.*

U U

EXPERT IN

Shop Practice Pertaining to Sheet Metal Formation, The Press Working of Metals, Patent Causes, Machinery and Tools Involved: In Steel Treatment and Tempering, In Interchangeable Manufacturing of Machinery, In Drop Forging and Die Sinking, and in the Reduction of Shop and Labor Costs.

U U

Joseph V. Woodworth

Mechanical Expert and Engineer

Forty-Two South Eighth Street

Brooklyn, N. Y.

All inquiries given my personal attention

1911

CATALOGUE

of

Practical Books



Published and for sale by

The Norman W. Henley Publishing Company

Publishers of Scientific and Practical Books

132 NASSAU STREET NEW YORK, U.S.A.

All books in this Catalogue sent prepaid on receipt or price.

SUBJECT INDEX

	PAGE		PAGE
Air Brakes.....	3, 12, 13	Manual Training.....	16
Arithmetics.....	7, 15, 20	Marine Engines.....	16
Balloons.....	3	Mechanical Movements.....	15
Bevel Gears.....	3	Metal Turning.....	11
Boilers.....	3, 13, 16	Milling Machines.....	17
Brazing.....	3	Mining.....	16
Cams.....	11	Oil Engines.....	11
Car Charts.....	3	Patents.....	10
Change Gear.....	11	Pattern Making.....	17
Charts.....	3	Perfumery.....	17
Chemistry.....	10, 17	Pipes.....	20
Coal Mining.....	17	Plumbing.....	18
Coke.....	4	Producer Gas.....	10
Compressed Air.....	4	Punches.....	6
Concrete.....	4, 5	Receipt Book.....	18
Cyclopedias.....	4	Refrigeration.....	11
Dictionaries.....	5	Rubber Stamps.....	18
Dies.....	6	Saws.....	18
Drawing.....	6, 18	Sheet Metal Working.....	6
Drop Forging.....	6	Shop Tools.....	6
Dynamo.....	7, 8	Shop Construction.....	15
Electricity.....	7, 8, 9	Shop Management.....	15
Engines and Boilers.....	3	Sketching Paper.....	6
Flying Machines.....	10	Smoke Prevention.....	9, 12
Fuel.....	9, 12	Soldering.....	3
Gas Manufacturing.....	10	Steam Engineering.....	19, 20
Gas Engines.....	10	Steam Heating.....	20
Gears.....	10	Steam Pipes.....	20
Heating Electric.....	7	Steel.....	20
Hot Water Heating.....	12	Superheated Steam.....	20
Horse-Power Chart.....	19	Switchboards.....	7, 8
Hydraulics.....	11	Tapers.....	12
Ice Making.....	11	Telephone.....	9
India Rubber.....	18	Threads.....	16
Interchangeable Manufacturing.....	14	Tools.....	14, 15, 16
Inventions.....	20	Ventilation.....	11
Lathes.....	11	Valve Gear.....	14
Lighting (Electric).....	7	Valve Setting.....	13
Link Motion.....	13	Walschaert Valve Gear.....	14
Liquid Air.....	12	Watchmaking.....	20
Locomotive Engineering.....	12, 13, 14	Wiring.....	7, 9
Machinist's Books.....	14, 15, 16	Wireless Telephones.....	9

INDEX BY AUTHORS

	PAGE		PAGE		PAGE
Alexander, J. H.....	3	Erskine-Murray.....	9	Perrigo, Oscar E.....	9, 11, 15
Askinson, G. W.....	17	Fowler, Geo. L.....	3, 13	Pratt, H.....	9
Barr, Wm. M.....	9, 12	Garbe, Robert.....	12	Putnam, Xenon W.....	10
Barrows, F. W.....	17	Goddard, Dwight.....	19	Radcliffe and Cushing.....	9
Bauer, Dr. G.....	16	Grimshaw, Robert.....	13, 16, 18, 19	Richards-Colvin.....	6
Baxter, Wm.....	7, 8	Harrison, Newton.....	7	Rouillion, Louis.....	11, 16
Benjamin, Park.....	16	Haslam, Arthur P.....	8	Royle, H. M.....	10
Blackall, R. H.....	12, 13	Hiscox, G. D.....	4, 10, 11, 15, 17, 18, 19	Saunier, Claudius.....	20
Booth and Kershaw.....	9	Hobart, J. F.....	3	Sloane, T. O'Conor.....	5, 7, 8, 12, 18
Booth, Wm. H.....	20	Hornor, J. G.....	4, 11, 14, 16	Starbuck, R. M.....	18
Buchetti, J.....	19	Houghton, A. A.....	4, 5	Sylvester and Oberg.....	6
Byrom, T. H.....	17	Johnson, J. P.....	17	Usher, John T.....	15
Byrom and Christopher.....	4	King, A. G.....	20	Vandervoort, W. H.....	15
Cockin, T. H.....	17	Kleinbans, F. A.....	13	Walker, S. F.....	7
Colvin, Fred H.....	12, 13	Kraus, H. T. C.....	6	Wallis-Taylor, A. J.....	11
Colvin-Cheney.....	15, 20	Lewis, M. H.....	5	Weed, A. J.....	7
Colvin-Stabel.....	16	Lummis-Paterson.....	8	Wood, Wm. W.....	14
Crane, W. E.....	19	Markham, E. R.....	20	Woodworth, J. V.....	6, 14, 20
Dalby, H. A.....	14	Mathot, R. E.....	10	Wright, J.....	7
Engstrom, D. Ag.....	10	Parsell and Weed.....	10		

ANY BOOK ADVERTISED IN THIS CATALOGUE WILL BE SENT PROMPTLY TO ANY ADDRESS IN THE WORLD, CHARGES PREPAID, UPON RECEIPT OF PRICE.

How to Remit.—Remit by Postal Money Order, Express Money Order, Bank Draft or Registered Letter.

CATALOGUE OF GOOD, PRACTICAL BOOKS

BALLOONS AND FLYING MACHINES

MODEL BALLOONS AND FLYING MACHINES. WITH A SHORT ACCOUNT OF THE PROGRESS OF AVIATION. By J. H. ALEXANDER.

This book has been written with a view to assist those who desire to construct a model airship or flying machine. It contains five folding plates of working drawings, each sheet containing a different sized machine. Much instruction and amusement can be obtained from the making and flying of these models.

A short account of the progress of aviation is included, which will render the book of greater interest. Several illustrations of full sized airship and flying machines of the latest types are scattered throughout the text. This practical work gives data, working drawings, and details which will assist materially those interested in the problems of flight. 127 pages, 45 illustrations, 5 folding plates. Price \$1.50

BRAZING AND SOLDERING

BRAZING AND SOLDERING. By JAMES F. HOBART.

The only book that shows you just how to handle any job of brazing or soldering that comes along; tells you what mixture to use, how to make a furnace if you need one. Full of kinks. Fourth edition. 25 cents

CHARTS

BOX CAR CHART.

A chart showing the anatomy of a box car, having every part of the car numbered and its proper name given in a reference list. 20 cents

GONDOLA CAR CHART.

A chart showing the anatomy of a gondola car, having every part of the car numbered and its proper reference name given in a reference list. 20 cents

PASSENGER CAR CHART.

A chart showing the anatomy of a passenger car, having every part of the car numbered and its proper name given in a reference list. 20 cents

WESTINGHOUSE AIR-BRAKE CHARTS.

Chart I.—Shows (in colors) the most modern Westinghouse High Speed and Signal Equipment used on Passenger Engines, Passenger Engine Tenders, and Passenger Cars. Chart II.—Shows (in colors) the Standard Westinghouse Equipment for Freight and Switch Engines, Freight and Switch Engine Tenders, and Freight Cars. Price for the set 50 cents

TRACTION POWER CHART.

A chart whereby you can find the tractive power or drawbar pull of any locomotive, without making a figure. Shows what cylinders are equal, how driving wheels and steam pressure affect the power. What sized engine you need to exert a given drawbar pull or anything you desire in this line. 50 cents

HORSE POWER CHART.

Shows the horse power of any stationary engine without calculation. No matter what the cylinder diameter of stroke; the steam pressure or cut-off; the revolutions, or whether condensing or non-condensing, it's all there. Easy to use, accurate, and saves time and calculations. Especially useful to engineers and designers. 50 cents

BOILER ROOM CHART. By GEO. L. FOWLER.

A Chart—size 14 x 28 inches—showing in isometric perspective the mechanisms belonging in a modern boiler room. Water tube boilers, ordinary grates and mechanical stokers, feed water heaters and pumps comprise the equipment. The various parts are shown broken or removed, so that the internal construction is fully illustrated. Each part is given a reference number, and these, with the corresponding name, are given in a glossary printed at the sides. This chart is really a dictionary of the boiler room—the names of more than 200 parts being given. It is educational—worth many times its cost. 25 cents

CATALOGUE OF GOOD, PRACTICAL BOOKS

CIVIL ENGINEERING

HENLEY'S ENCYCLOPEDIA OF PRACTICAL ENGINEERING AND ALLIED TRADES.

Edited by JOSEPH G. HORNER, A.M.I., M.E.

This set of five volumes contains about 2,500 pages with thousands of illustrations, including diagrammatic and sectional drawings with full explanatory details. This work covers the entire practice of Civil and Mechanical Engineering. The best known experts in all branches of engineering have contributed to these volumes. The Cyclopaedia is admirably well adapted to the needs of the beginner and the self-taught practical man, as well as the mechanical engineer, designer, draftsman, shop superintendent, foreman, and machinist. The work will be found a means of advancement to any progressive man. It is encyclopedic in scope, thorough and practical in its treatment of technical subjects, simple and clear in its descriptive matter, and without unnecessary technicalities or formulae. The articles are as brief as may be and yet give a reasonably clear and explicit statement of the subject, and are written by men who have had ample practical experience in the matters of which they write. It tells you all you want to know about engineering and tells it so simply, so clearly, so concisely, that one cannot help but understand. As a work of reference it is without a peer. \$6.00 per volume. For complete set of five volumes, price \$25.00

COKE

COKE—MODERN COKING PRACTICE; INCLUDING THE ANALYSIS OF MATERIALS AND PRODUCTS. By T. H. BYROM and J. E. CHRISTOPHER.

A handbook for those engaged in Coke manufacture and the recovery of By-products. Fully illustrated with folding plates. It has been the aim of the authors, in preparing this book, to produce one which shall be of use and benefit to those who are associated with, or interested in, the modern developments of the industry. Contents: I. Introductory. II. General Classification of Fuels. III. Coal Washing. IV. The Sampling and Valuation of Coal, Coke, etc. V. The Calorific Power of Coal and Coke. VI. Coke Ovens. VII. Coke Ovens, continued. VIII. Coke Ovens, continued. IX. Charging and Discharging of Coke Ovens. X. Cooling and Condensing Plant. XI. Gas Exhausters. XII. Composition and Analysis of Ammoniacal Liquor. XIII. Working-up of Ammoniacal Liquor. XIV. Treatment of Waste Gases from Sulphate Plants. XV. Valuation of Ammonium Sulphate. XVI. Direct Recovery of Ammonia from Coke Oven Gases. XVII. Surplus Gas from Coke Oven. Useful Tables. Very fully illustrated. Price \$3.50 net

COMPRESSED AIR

COMPRESSED AIR IN ALL ITS APPLICATIONS. By GARDNER D. HISCOX.

This is the most complete book on the subject of Air that has even been issued, and its thirty-five chapters include about every phase of the subject one can think of. It may be called an encyclopedia of compressed air. It is written by an expert, who, in his 665 pages, has dealt with the subject in a comprehensive manner, no phase of it being omitted. Over 500 illustrations, 5th Edition, revised and enlarged. Cloth bound, \$5.00: Half Morocco, price \$6.50

CONCRETE

ORNAMENTAL CONCRETE WITHOUT MOLDS. By A. A. HOUGHTON.

The process for making ornamental concrete without molds, has long been held as a secret and now, for the first time, this process is given to the public. The book reveals the secret and is the only book published which explains a simple, practical method whereby the concrete worker is enabled, by employing wood and metal templates of different designs, to mold or model in concrete any Cornice, Archivolt, Column, Pedestal, Base Cap, Urn or Pier in a monolithic form—right upon the job. These may be molded in units or blocks, and then built up to suit the specifications demanded. This work is fully illustrated, with detailed engravings. Price \$2.00

CONCRETE FROM SAND MOLDS. By A. A. HOUGHTON.

A Practical Work treating on a process, which has heretofore been held as a trade secret, by the few who possessed it, and which will successfully mold every and any class of ornamental concrete work. The process of molding concrete with sand molds is of the utmost practical value, possessing the manifold advantages of a low cost of molds, the ease and rapidity of operation, perfect details to all ornamental designs, density, and increased strength of the concrete, perfect curing of the work without attention and the easy removal of the molds regardless of any undercutting the design may have. 192 pages. Fully illustrated. Price \$2.00

CONCRETE WALL FORMS. By A. A. HOUGHTON.

A new automatic wall clamp is illustrated with working drawings. Other types of wall forms, clamps, separators, etc., are also illustrated and explained. 50 cents

CONCRETE FLOORS AND SIDEWALKS. By A. A. HOUGHTON.

The molds for molding squares, hexagonal and many other styles of mosaic floor and sidewalk blocks are fully illustrated and explained. 50 cents

CATALOGUE OF GOOD, PRACTICAL BOOKS

CONCRETE SILOS. By A. A. HOUGHTON.

Complete working drawings and specifications are given for several styles of concrete silos, with illustrations of molds for inolithic and block silos. The tables, data and information presented in this book are of the utmost value in planning and constructing all forms of concrete silos. 50 cents

CONCRETE CHIMNEYS, SLATE AND ROOF TILES. By A. A. HOUGHTON.

The manufacture of all types of concrete slate and roof tile is fully treated. Valuable data on all forms of reinforced concrete roofs are contained within its pages. The construction of concrete chimneys by block and monolithic systems is fully illustrated and described. A number of ornamental designs of chimney construction with molds are shown in this valuable treatise. 50 cents

MOLDING AND CURING ORNAMENTAL CONCRETE. By A. A. HOUGHTON.

The proper proportions of cement and aggregates for various finishes, also the methods of thoroughly mixing and placing in the molds, are fully treated. An exhaustive treatise on this subject that every concrete worker will find of daily use and value. 50 cents

CONCRETE MONUMENTS, MAUSOLEUMS AND BURIAL VAULTS. By A. A. HOUGHTON.

The molding of concrete monuments to imitate the most expensive cut stone is explained in this treatise, with working drawings of easily built molds. Cutting inscriptions and designs is also fully treated. 50 cents

CONCRETE BATH TUBS, AQUARIUMS AND NATATORIUMS. By A. A. HOUGHTON.

Simple molds and instruction are given for molding many styles of concrete bath tubs, swimming pools, etc. These molds are easily built and permit rapid and successful work. 50 cents

ARTISTIC CONCRETE BRIDGES. By A. A. HOUGHTON.

A number of ornamental concrete bridges with illustrations of molds are given. A collapsible center or core for bridges, culverts and sewers is fully illustrated with detailed instructions for building 50 cents

CONSTRUCTING CONCRETE PORCHES. By A. A. HOUGHTON.

A number of designs with working drawings of molds are fully explained so any one can easily construct different styles of ornamental concrete porches without the purchase of expensive molds. 50 cents

CONCRETE FLOWER POTS, BOXES AND JARDINIÈRES. By A. A. HOUGHTON.

The molds for producing many original designs of flower pots, urns, flower boxes, jardinières, etc., are fully illustrated and explained, so the worker can easily construct and operate same. 50 cents

CONCRETE FOUNTAINS AND LAWN ORNAMENTS. By A. A. HOUGHTON.

The molding of a number of designs of lawn seats, curbing, hitching posts, pergolas, sun dials and other forms of ornamental concrete for the ornamentation of lawns and gardens, is fully illustrated and described. 50 cents

CONCRETE FOR THE FARM AND SHOP. By A. A. HOUGHTON.

The molding of drain tile, tanks, cisterns, fence posts, stable floors, hog and poultry houses and all the purposes for which concrete is an invaluable aid to the farmer are numbered among the contents of this handy volume. 50 cents

POPULAR HANDBOOK FOR CEMENT AND CONCRETE USERS. By MYRON H. LEWIS.

This is a concise treatise of the principles and methods employed in the manufacture and use of cement in all classes of modern works. The author has brought together in this work, all the salient matter of interest to the user of concrete and its many diversified products. The matter is presented in logical and systematic order, clearly written, fully illustrated and free from involved mathematics. Everything of value to the concrete user is given including kinds of cement employed in construction, concrete architecture, inspection and testing, waterproofing, coloring and painting, rules, tables, working, and cost data. Price \$2.50

DICTIONARIES

STANDARD ELECTRICAL DICTIONARY. By T. O'CONNOR SLOANE.

An indispensable work to all interested in electrical science. Suitable alike for the student and professional. A practical hand-book of reference containing definitions of about 5,000 distinct words, terms and phrases. The definitions are terse and concise and include every term used in electrical science. Recently issued. An entirely new edition. Should be in the possession of all who desire to keep abreast with the progress of this branch of science. Complete, concise and convenient. 682 pages. 393 illustrations. Price. \$3.00

CATALOGUE OF GOOD, PRACTICAL BOOKS

DIES—METAL WORK

DIES, THEIR CONSTRUCTION AND USE FOR THE MODERN WORKING OF SHEET METALS. By J. V. WOODWORTH.

A most useful book, and one which should be in the hands of all engaged in the press working of metals; treating on the Designing, Constructing, and Use of Tools, Fixtures and Devices, together with the manner in which they should be used in the Power Press, for the cheap and rapid production of the great variety of sheet metal articles now in use. It is designed as a guide to the production of sheet metal parts at the minimum of cost with the maximum of output. The hardening and tempering of Press tools and the classes of work which may be produced to the best advantage by the use of dies in the power press are fully treated. Its 505 illustrations show dies, press fixtures and sheet metal working devices, the descriptions of which are so clear and practical that all metal-working mechanics will be able to understand how to design, construct and use them. Many of the dies and press fixtures treated were either constructed by the author or under his supervision. Others were built by skillful mechanics and are in use in large sheet metal establishments and machine shops. Price **\$3.00**

PUNCHES, DIES AND TOOLS FOR MANUFACTURING IN PRESSES. By J. V. WOODWORTH.

This work is a companion volume to the author's elementary work entitled "Dies, Their Construction and Use." It does not go into the details of die making to the extent of the author's previous book, but gives a comprehensive review of the field of operations carried on by presses. A large part of the information given has been drawn from the author's personal experience. It might well be termed an Encyclopedia of Die Making, Punch Making, Die Sinking, Sheet Metal Working, and Making of Special Tools, Sub-presses, Devices and Mechanical Combinations for Punching, Cutting, Bending, Forming, Piercing, Drawing, Compressing and Assembling Sheet Metal Parts, and also Articles of other Materials in Machine Tools. Price **\$4.00**

DROP FORGING, DIE SINKING AND MACHINE FORMING OF STEEL. By J. V. WOODWORTH.

This is a practical treatise on Modern Shop Practice, Processes, Methods, Machines, Tools and Details, treating on The Hot and Cold Machine-Forming of Steel and Iron into Finished Shapes; Together with Tools, Dies, and Machinery involved in the manufacture of Duplicate Forgings and Interchangeable Hot and Cold Pressed Parts from Bar and Sheet Metal. Fully illustrated by 300 detailed illustrations. Price **\$2.50**

DRAWING—SKETCHING PAPER

LINEAR PERSPECTIVE SELF-TAUGHT. By HERMAN T. C. KRAUS.

This work gives the theory and practice of linear perspective, as used in architectural, engineering, and mechanical drawings. Persons taking up the study of the subject by themselves will be able by the use of the instruction given to readily grasp the subject, and by reasonable practice become good perspective draftsmen. The arrangement of the book is good; the plate is on the left-hand, while the descriptive text follows on the opposite page, so as to be readily referred to. The drawings are on sufficiently large scale to show the work clearly and are plainly figured. The whole work makes a very complete course on perspective drawing, and will be found of great value to architects, civil and mechanical engineers, patent attorneys, art designers, engravers, and draftsmen. Price **\$2.50**

PRACTICAL PERSPECTIVE. By RICHARDS and COLVIN.

Shows just how to make all kinds of mechanical drawings in the only practical perspective isometric. Makes everything plain so that any mechanic can understand a sketch or drawing in this way. Saves time in the drawing room, and mistakes in the shops. Contains practical examples of various classes of work. Price **50 cents**

SELF-TAUGHT MECHANICAL DRAWING AND ELEMENTARY MACHINE DESIGN.

By F. L. SYLVESTER, M.E., Draftsman, with additions by ERIC OBERG, associate editor of "Machinery."

This is a practical treatise on Mechanical Drawing and Machine Design, comprising the first principles of geometric and mechanical drawing, workshop mathematics, mechanics, strength of materials and the calculations and design of machine details. Specially prepared for the practical mechanic and young draftsman. It is primarily intended for the man who must study without a teacher. It is clearly written, comprehensive, and carefully arranged. Price **\$2.00**

A NEW SKETCHING PAPER.

A new specially ruled paper to enable you to make sketches or drawings in isometric perspective without any figuring or fussing. It is being used for shop details as well as for assembly drawings, as it makes one sketch do the work of three, and no workman can help seeing just what is wanted. Pads of 40 sheets, 6 x 9 inches, **25 cents**. Pads of 40 sheets, 9 x 12 inches, **50 cents**

CATALOGUE OF GOOD, PRACTICAL BOOKS

ELECTRICITY

ARITHMETIC OF ELECTRICITY. By Prof. T. O'CONNOR SLOANE.

A practical treatise on electrical calculations of all kinds reduced to a series of rules, all of the simplest forms, and involving only ordinary arithmetic; each rule illustrated by one or more practical problems, with detailed solution of each one. This book is classed among the most useful works published on the science of electricity covering as it does the mathematics of electricity in a manner that will attract the attention of those who are not familiar with algebraical formulas. 160 pages. Price \$1.00

COMMUTATOR CONSTRUCTION. By WM. BAXTER, JR.

The business end of any dynamo or motor of the direct current type is the commutator. This book goes into the designing, building, and maintenance of commutators, shows how to locate troubles and how to remedy them; everyone who fusses with dynamos needs this. 25 cents

DYNAMO BUILDING FOR AMATEURS, OR HOW TO CONSTRUCT A FIFTY-WATT DYNAMO. By ARTHUR J. WEED, Member of N. Y. Electrical Society.

This book is a practical treatise showing in detail the construction of a small dynamo or motor, the entire machine work of which can be done on a small foot lathe. Dimensioned working drawings are given for each piece of machine work and each operation is clearly described.

This machine, when used as a dynamo, has an output of fifty watts; when used as a motor it will drive a small drill press or lathe. It can be used to drive a sewing machine on any and all ordinary work.

The book is illustrated with more than sixty original engravings showing the actual construction of the different parts. Price, paper, 50 cents. Cloth \$1.00

ELECTRIC FURNACES AND THEIR INDUSTRIAL APPLICATIONS. By J. WRIGHT.

This is a book which will prove of interest to many classes of people; the manufacturer who desires to know what product can be manufactured successfully in the electric furnace, the chemist who wishes to post himself on the electro-chemistry, and the student of science who merely looks into the subject from curiosity. The book is not so scientific as to be of use only to the technologist, nor so unscientific as to suit only the tyro in electro-chemistry; it is a practical treatise of what has been done, and of what is being done, both experimentally and commercially with the electric furnace.

In important processes not only are the chemical equations given, but complete thermal data are set forth and both the efficiency of the furnace and the cost of the product are worked out, thus giving the work a solid commercial value aside from its efficacy as a work of reference. The practical features of furnace building are given the space that the subject deserves. The forms and refractory materials used in the linings, the arrangement of the connections to the electrodes, and other important details are explained. 288 pages. New Revised Edition. Fully illustrated. Price \$3.00

ELECTRIC LIGHTING AND HEATING POCKET BOOK. By SYDNEY F. WALKER.

This book puts in convenient form useful information regarding the apparatus which is likely to be attached to the mains of an electrical company. Tables of units and equivalents are included and useful electrical laws and formulas are stated.

One section is devoted to dynamos, motors, transformers and accessory apparatus; another to accumulators, another to switchboards and related equipment, a fourth to a description of various systems of distribution, a fifth section to a discussion of instruments, both for portable use and switchboards; another section deals with electric lamps of various types and accessory appliances, and the concluding section is given up to electric heating apparatus. In each section a large number of commercial types are described, frequent tables of dimensions being included. A great deal of detail information of each line of apparatus is given and the illustrations shown give a good idea of the general appearance of the apparatus under discussion. The book also contains much valuable information for the central station engineer. 438 pages. 300 engravings. Bound in leather pocket book form. Price . . \$3.00

ELECTRIC TOY MAKING, DYNAMO BUILDING, AND ELECTRIC MOTOR CONSTRUCTION. By Prof. T. O'CONNOR SLOANE.

This work treats of the making at home of electrical toys, electrical apparatus, motors, dynamos and instruments in general, and is designed to bring within the reach of young and old the manufacture of genuine and useful electrical appliances. The work is especially designed for amateurs and young folks.

Thousands of our young people are daily experimenting, and busily engaged in making electrical toys and apparatus of various kinds. The present work is just what is wanted to give the much needed information in a plain, practical manner, with illustrations to make easy the carrying out of the work. Price \$1.00

ELECTRIC WIRING, DIAGRAMS AND SWITCHBOARDS. By NEWTON HARRISON.

This is the only complete work issued showing and telling you what you should know about direct and alternating current wiring. It is a ready reference. The work is free from advanced technicalities and mathematics, arithmetic being used throughout. It is in every respect a handy, well-written, instructive, comprehensive volume on wiring for the wireman, foreman, contractor or electrician. 272 pages; 105 illustrations. Price \$1.50

CATALOGUE OF GOOD, PRACTICAL BOOKS

ELECTRICIAN'S HANDY BOOK. By Prof. T. O'CONOR SLOANE.

This work of 768 pages is intended for the practical electrician who has to make things go. The entire field of electricity is covered within its pages. Among some of the subjects treated are: The Theory of the Electric Current and Circuit, Electro-Chemistry, Primary Batteries, Storage Batteries, Generation and Utilization of Electric Powers, Alternating Current, Armature Winding, Dynamos and Motors, Motor Generators, Operation of the Central Station Switchboards, Safety Appliances, Distribution of Electric Light and Power, Street Mains, Transformers, Arc and Incandescent Lighting, Electric Measurements, Photometry, Electric Railways, Telephony, Bell-Wiring, Electro-Plating, Electric Heating, Wireless Telegraphy, etc. It contains no useless theory; everything is to the point. It teaches you just what you want to know about electricity. It is the standard work published on the subject. Forty-one chapters, 610 engravings, handsomely bound in red leather with title and edges in gold. Price: **\$3.50**

ELECTRICITY IN FACTORIES AND WORKSHOPS, ITS COST AND CONVENIENCE.

By ARTHUR P. HASLAM.

A practical book for power producers and power users showing what a convenience the electric motor, in its various forms, has become to the modern manufacturer. It also deals with the conditions which determine the cost of electric driving, and compares this with other methods of producing and utilizing power.

Among the chapters contained in the book are: The Direct Current Motor; The Alternating Current Motor; The Starting and Speed Regulation of Electric Motors; The Rating and Efficiency of Electric Motors; The Cost of Energy as Affected by Conditions of Working, The Question for the Small Power User; Independent Generating Plants; Oil and Gas Engine Plants; Steam Plants; Power Station Tariffs; The Use of Electric Power in Textile Factories; Electric Power in Printing Works; The Use of Electric Power in Engineering Workshops Miscellaneous Application of Electric Power; The Installation of Electric Motors; The Lighting of Industrial-Establishments. 312 pages. Very fully illustrated. Price. **2.50**

ELECTRICITY SIMPLIFIED. By Prof. T. O'CONOR SLOANE.

The object of "Electricity Simplified" is to make the subject as plain as possible and to show what the modern conception of electricity is; to show how two plates of different metals immersed in acid can send a message around the globe; to explain how a bundle of copper wire rotated by a steam engine can be the agent in lighting our streets, to tell what the volt, ohm and ampere are, and what high and low tension mean; and to answer the questions that perpetually arise in the mind in this age of electricity. 172 pages. Illustrated. Price **£1.00**

HOW TO BECOME A SUCCESSFUL ELECTRICIAN. By Prof. T. O'CONOR SLOANE.

Every young man who wishes to become a successful electrician should read this book. It tells in simple language the surest and easiest way to become a successful electrician. The studies to be followed, methods of work, field of operation and the requirements of the successful electrician are pointed out and fully explained. Every young engineer will find this an excellent stepping-stone to more advanced works on electricity which he must master before success can be attained. Many young men become discouraged at the very outset by attempting to read and study books that are far beyond their comprehension. This book serves as the connecting link between the rudiments taught in the public schools and the real study of electricity. It is interesting from cover to cover. Twelfth edition. 202 pages. Illustrated. Price **\$1.00**

MANAGEMENT OF DYNAMOS. By LUMMIS-PATERSON.

A handbook of theory and practice. This work is arranged in three parts. The first part covers the elementary theory of the dynamo. The second part, the construction and action of the different classes of dynamos in common use are described; while the third part relates to such matters as affect the practical management and working of dynamos and motors. The following chapters are contained in the book: Electrical Units; Magnetic Principles; Theory of the Dynamo; Armature; Armature in Practice; Field Magnets; Field Magnets in Practice; Regulating Dynamos; Coupling Dynamos; Installation, Running, and Maintenance of Dynamos; Faults in Dynamos; Faults in Armatures; Motors. 292 pages. 117 illustrations. Price **\$1.50**

STANDARD ELECTRICAL DICTIONARY. By T. O'CONOR SLOANE.

An indispensable work to all interested in electrical science. Suitable alike for the student and professional. A practical hand-book of reference containing definitions of about 5,000 distinct words, terms and phrases. The definitions are terse and concise and include every term used in electrical science. Recently issued. An entirely new edition. Should be in the possession of all who desire to keep abreast with the progress of this branch of science. Complete, concise, and convenient. 682 pages. 393 illustrations. Price **\$3.00**

SWITCHBOARDS. By WILLIAM BAXTER, JR.

This book appeals to every engineer and electrician who wants to know the practical side of things. It takes up all sorts and conditions of dynamos, connections and circuits and shows by diagram and illustration just how the switchboard should be connected. Includes direct and alternating current boards, also those for arc lighting, incandescent, and power circuits. Special treatment on high voltage boards for power transmission. 190 pages. Illustrated. Price **\$1.50**

CATALOGUE OF GOOD, PRACTICAL BOOKS

TELEPHONE CONSTRUCTION, INSTALLATION, WIRING, OPERATION AND MAINTENANCE. By W. H. RADCLIFFE and H. C. CUSHING.

This book gives the principles of construction and operation of both the Bell and Independent instruments; approved methods of installing and wiring them; the means of protecting them from lightning and abnormal currents; their connection together for operation as series or bridging stations; and rules for their inspection and maintenance. Line wiring and the wiring and operation of special telephone systems are also treated.

Intricate mathematics are avoided, and all apparatus, circuits and systems are thoroughly described. The appendix contains definitions of units and terms used in the text. Selected wiring tables, which are very helpful, are also included. 100 pages, 125 illustrations. \$1.00

WIRING A HOUSE. By HERBERT PRATT.

Shows a house already built; tells just how to start about wiring it; where to begin; what wire to use; how to run it according to Insurance Rules; in fact just the information you need. Directions apply equally to a shop. Fourth edition. 25 cents

WIRELESS TELEPHONES AND HOW THEY WORK. By JAMES ERSKINE-MURRAY.

This work is free from elaborate details and aims at giving a clear survey of the way in which Wireless Telephones work. It is intended for amateur workers and for those whose knowledge of electricity is slight. Chapters contained: How We Hear; Historical; The Conversion of Sound into Electric Waves; Wireless Transmission; The Production of Alternating Currents of High Frequency; How the Electric Waves are Radiated and Received; The Receiving Instruments; Detectors; Achievements and Expectations; Glossary of Technical Work. Cloth. Price. \$1.00

FACTORY MANAGEMENT, ETC.

MORERN MACHINE SHOP CONSTRUCTION, EQUIPMENT AND MANAGEMENT. By O. E. PERRIGO, M.E.

The only work published that describes the modern machine shop or manufacturing plant from the time the grass is growing on the site intended for it until the finished product is shipped. By a careful study of its thirty-two chapters the practical man may economically build, efficiently equip, and successfully manage the modern machine shop or manufacturing establishment. Just the book needed by those contemplating the erection of modern shop buildings, the re-building and re-organization of old ones, or the introduction of modern shop methods, time and cost system. It is a book written and illustrated by a practical shop man for practical shop men who are too busy to read *theories* and want *facts*. It is the most complete all around book of its kind ever published. It is a practical book for practical men, from the apprentice in the shop to the president in the office. It minutely describes and illustrates the most simple and yet the most efficient time and cost system yet devised. Price \$5.00

FUEL

COMBUSTION OF COAL AND THE PREVENTION OF SMOKE. By WM. M. BARR.

This book has been prepared with special reference to the generation of heat by the combustion of the common fuels found in the United States, and deals particularly with the conditions necessary to the economic and smokeless combustion of bituminous coals in Stationary and Locomotive Steam Boilers.

The presentation of this important subject is systematic and progressive. The arrangement of the book is in a series of practical questions to which are appended accurate answers, which describe in language, free from technicalities, the several processes involved in the furnace combustion of American fuels; it clearly states the essential requisites for perfect combustion, and points out the best methods of furnace construction for obtaining the greatest quantity of heat from any given quality of coal. Nearly 350 pages, fully illustrated. \$1.00

SMOKE PREVENTION AND FUEL ECONOMY. By BOOTH and KERSHAW.

A complete treatise for all interested in smoke prevention and combustion, being based on the German work of Ernst Schmatolla, but it is more than a mere translation of the German treatise, much being added. The authors show as briefly as possible the principles of fuel combustion, the methods which have been and are at present in use, as well as the proper scientific methods for obtaining all the energy in the coal and burning it without smoke. Considerable space is also given to the examination of the waste gases, and several of the representative English and American mechanical stoker and similar appliances are described. The losses carried away in the waste gases are thoroughly analyzed and discussed in the Appendix, and abstracts are also here given of various patents on combustion apparatus. The book is complete and contains much of value to all who have charge of large plants. 194 pages, illustrated. Price \$2.50

CATALOGUE OF GOOD, PRACTICAL BOOKS

GAS ENGINES AND GAS

CHEMISTRY OF GAS MANUFACTURE. By H. M. ROYLES.

This book covers points likely to arise in the ordinary course of the duties of the engineer or manager of a gas works not large enough to necessitate the employment of a separate chemical staff. It treats of the testing of the raw materials employed in the manufacture of illuminating coal gas, and of the gas produced. The preparation of standard solutions is given as well as the chemical and physical examination of gas coal including among its contents—Preparations of Standard Solutions, Coal, Furnaces, Testing and Regulation. Products of Carbonization. Analysis of Crude Coal Gas. Analysis of Lime. Ammonia. Analysis of Oxide of Iron. Naphthalene. Analysis of Fire-Bricks and Fire-Clay. Weldon and Spent Oxide. Photometry and Gas Testing. Carburetted Water Gas. Metropolis Gas. Miscellaneous Extracts. Useful Tables. \$4.50

AGRICULTURAL GAS ENGINES. By XENO W. PUTNAM.

The gas engine within the past few years is being so much used on the farm to simplify work, that the publication of this practical treatise will prove of greatest value. The author takes up first, and treats in detail the working of the engine, then the transmission mediums are treated, as well as traction engines and their application. Price \$1.50

GAS ENGINE CONSTRUCTION, OR HOW TO BUILD A HALF-HORSE-POWER GAS ENGINE. By PARSELL and WEED.

A practical treatise of 300 pages describing the theory and principles of the action of Gas Engines of various types and the design and construction of a half-horse power Gas Engine, with illustrations of the work in actual progress, together with the dimensioned working drawings giving clearly the sizes of the various details; for the student, the scientific investigator and the amateur mechanic.

This book treats of the subject more from the standpoint of practice than that of theory. The principles of operation of Gas Engines are clearly and simply described and then the actual construction of a half-horse power engine is taken up, step by step, showing in detail the making of the Gas Engine. 300 pages. Price \$2.50

GAS, GASOLINE, AND OIL ENGINES. By GARDNER D. HISCOX.

Just issued, 18th revised and enlarged edition. Every user of a gas engine needs this book. Simple, instructive, and right up-to-date. The only complete work on the subject. Tells all about the running and management of gas, gasoline and oil engines, as designed and manufactured in the United States. Explosive motors for stationary, marine and vehicle power are fully treated, together with illustrations of their parts and tabulated sizes, also their care and running are included. Electric ignition by induction coil and jump spark are fully explained and illustrated, including valuable information on the testing for economy and power and the erection of power plants.

The rules and regulations of the Board of Fire Underwriters in regard to the installation and management of gasoline motors is given in full, suggesting the safe installation of explosive motor power. A list of United States Patents issued on gas, gasoline, and oil engines and their adjuncts from 1875 to date is included. 484 pages. 410 engravings Price . . \$2.50 net

MODERN GAS ENGINES AND PRODUCER GAS PLANTS. By R. E. MATHOT, M.E.

A guide for the gas engine designer, user, and engineer in the construction, selection, purchase, installation, operation, and maintenance of gas engines. More than one book on gas engines has been written, but not one has thus far even encroached on the field covered by this book. Above all Mr. Mathot's work is a practical guide. Recognizing the need of a volume that would assist the gas engine user in understanding thoroughly the motor upon which he depends for power, the author has discussed his subject without the help of any mathematics and without elaborate theoretical explanations. Every part of the gas engine is described in detail, tersely, clearly, with a thorough understanding of the requirements of the mechanic. Helpful suggestions as to the purchase of an engine, its installation, care, and operation form a most valuable feature of the work. 320 pages. 175 detailed illustrations. Price . . . \$2.50

GEARING AND CAMS

BEVEL GEAR TABLES. By D. AG. ENGSTROM.

A book that will at once commend itself to mechanics and draftsmen. Does away with all the trigonometry and fancy figuring on bevel gears and makes it easy for anyone to lay them out or make them just right. There are 36 full-page tables that show every necessary dimension for all sizes or combinations you're apt to need. No puzzling figuring or guessing. Gives placing distance, all the angles (including cutting angles), and the correct cutter to use. A copy of this prepares you for anything in the bevel gear line. 66 pages. . \$1.00

CATALOGUE OF GOOD, PRACTICAL BOOKS

CHANGE GEAR DEVICES. By OSCAR E. PERRIGO.

A practical book for every designer, draftsman, and mechanic interested in the invention and development of the devices for feed changes on the different machines requiring such mechanism. All the necessary information on this subject is taken up, analyzed, classified, sifted, and concentrated for the use of busy men who have not the time to go through the masses of irrelevant matter with which such a subject is usually encumbered and select such information as will be useful to them. It shows just what has been done, how it has been done, when it was done, and who did it. It saves time in hunting up patent records and re-inventing old ideas. 88 pages. \$1.00

DRAFTING OF CAMS. By LOUIS ROULLION.

The laying out of cams is a serious problem unless you know how to go at it right. This puts you on the right road for practically any kind of cam you are likely to run up against. 25 cents

HYDRAULICS

HYDRAULIC ENGINEERING. By GARDNER D. HISCOX.

A treatise on the properties, power, and resources of water for all purposes. Including the measurement of streams; the flow of water in pipes or conduits; the horse-power of falling water; turbine and impact water-wheels; wave-motors, centrifugal, reciprocating, and air-lift pumps. With 300 figures and diagrams and 36 practical tables. All who are interested in water-works development will find this book a useful one, because it is an entirely practical treatise upon a subject of present importance, and cannot fail in having a far-reaching influence, and for this reason should have a place in the working library of every engineer. 320 pages. Price \$4.00

ICE AND REFRIGERATION

POCKET BOOK OF REFRIGERATION AND ICE MAKING. By A. J. WALLIS-TAYLOR.

This is one of the latest and most comprehensive reference books published on the subject of refrigeration and cold storage. It explains the properties and refrigerating effect of the different fluids in use, the management of refrigerating machinery and the construction and insulation of cold rooms with their required pipe surface for different degrees of cold; freezing mixtures and non-freezing brines, temperatures of cold rooms for all kinds of provisions, cold storage charges for all classes of goods, ice making and storage of ice, data and memoranda for constant reference by refrigerating engineers, with nearly one hundred tables containing valuable references to every fact and condition required in the installment and operation of a refrigerating plant. Price \$1.50

INVENTIONS—PATENTS

INVENTOR'S MANUAL, HOW TO MAKE A PATENT PAY.

This is a book designed as a guide to inventors in perfecting their inventions, taking out their patents and disposing of them. It is not in any sense a Patent Solicitor's Circular, nor a Patent Broker's Advertisement. No advertisements of any description appear in the work. It is a book containing a quarter of a century's experience of a successful inventor, together with notes based upon the experience of many other inventors. Price \$1.00

LATHE WORK

MODERN AMERICAN LATHE PRACTICE. By OSCAR E. PERRIGO.

This is a new book from cover to cover, and the only complete American work on the subject written by a man who knows not only how work ought to be done but who also knows how to do it, and how to convey this knowledge to others. It is strictly up-to-date in its descriptions and illustrations, which represent the very latest practice in lathe and boring mill operations as well as the construction of and latest developments in the manufacture of these important classes of machine tools. 424 pages. 314 illustrations. Price \$2.50

PRACTICAL METAL TURNING. By JOSEPH G. HORNER.

This important and practical subject is treated in a full and exhaustive manner and nothing of importance is omitted. The principles and practice and all the different branches of Turning are considered and well illustrated. All the different kinds of Chucks of usual forms, as well as some unusual kinds, are shown. A feature of the book is the important section devoted to modern Turret practice; Boring is another subject which is treated fully; and the chapter on Tool Holders illustrates a large number of representative types. Thread Cutting is treated at reasonable length; and the last chapter contains a good deal of information relating to the High-Speed Steels and their work. The numerous tools used by machinists are illustrated, and also the adjuncts of the lathe. In fact, the entire subject is treated in such a thorough manner as to make this book the standard one on the subject. It is indispensable to the manager, engineer, and machinist as well as to the student, amateur, and experimental man who desires to keep up-to-date. 400 pages, fully illustrated. Price \$3.50

CATALOGUE OF GOOD, PRACTICAL BOOKS

TURNING AND BORING TAPERS. By FRED H. COLVIN.

There are two ways to turn tapers; the right way and one other. This treatise has to do with the right way; it tells you how to start the work properly, how to set the lathe, what tools to use and how to use them, and forty and one other little things that you should know. Fourth edition. 25 cents

LIQUID AIR

LIQUID AIR AND THE LIQUEFACTION OF GASES. By T. O'CONNOR SLOANE.

This book gives the history of the theory, discovery, and manufacture of Liquid Air, and contains an illustrated description of all the experiments that have excited the wonder of audiences all over the country. It shows how liquid air, like water, is carried hundreds of miles and is handled in open buckets. It tells what may be expected from it in the near future.

A book that renders simple one of the most perplexing chemical problems of the century. Startling developments illustrated by actual experiments.

It is not only a work of scientific interest and authority, but is intended for the general reader, being written in a popular style—easily understood by every one. Second edition. 365 pages. Price \$2.00

LOCOMOTIVE ENGINEERING

AIR-BRAKE CATECHISM. By ROBERT H. BLACKALL.

This book is a standard text book. It covers the Westinghouse Air-Brake Equipment, including the No. 5 and the No. 6 E. T Locomotive Brake Equipment; the K (Quick-Service) Triple Valve for Freight Service; and the Cross-Compound Pump. The operation of all parts of the apparatus is explained in detail, and a practical way of finding their peculiarities and defects, with a proper remedy, is given. It contains 2,000 questions with their answers, which will enable any railroad man to pass any examination on the subject of Air Brakes. Endorsed and used by air-brake instructors and examiners on nearly every railroad in the United States. 23d Edition. 380 pages, fully illustrated with folding plates and diagrams. \$2.00

AMERICAN COMPOUND LOCOMOTIVES. By FRED. H. COLVIN.

The only book on compounds for the engineman or shopman that shows in a plain, practical way the various features of compound locomotives in use. Shows how they are made, what to do when they break down or balk. Contains sections as follows:—A Bit of History. Theory of Compounding Steam Cylinders. Baldwin Two-Cylinder Compound. Pittsburg Two-Cylinder Compound. Rhode Island Compound. Richmond Compound. Rogers Compound. Schenectady Two-Cylinder Compound. Vauclain Compound. Tandem Compounds. Baldwin Tandem. The Colvin-Wightman Tandem. Schenectady Tandem. Balanced Locomotives. Baldwin Balanced Compound. Plans for Balancing. Locating Blows. Break-downs. Reducing Valves. Drifting. Valve Motion. Disconnecting. Power of Compound Locomotives. Practical Notes.

Fully illustrated and containing ten special "Duotone" inserts on heavy Plate Paper, showing different types of Compounds. 142 pages. Price \$1.00

APPLICATION OF HIGHLY SUPERHEATED STEAM TO LOCOMOTIVES. By ROBERT GARBE.

A practical book. Contains special chapters on Generation of Highly Superheated Steam; Superheated Steam and the Two-Cylinder Simple Engine; Compounding and Superheating; Designs of Locomotive Superheaters; Constructive Details of Locomotives using Highly Superheated Steam; Experimental and Working Results. Illustrated with folding plates and tables. Price \$2.50

COMBUSTION OF COAL AND THE PREVENTION OF SMOKE. By WM. M. BARR.

This book has been prepared with special reference to the generation of heat by the combustion of the common fuels found in the United States, and deals particularly with the conditions necessary to the economic and smokeless combustion of bituminous coals in Stationary and Locomotive Steam Boilers.

The presentation of this important subject is systematic and progressive. The arrangement of the book is in a series of practical questions to which are appended accurate answers, which describe in language, free from technicalities, the several processes involved in the furnace combustion of American fuels; it clearly states the essential requisites for perfect combustion, and points out the best methods of furnace construction for obtaining the greatest quantity of heat from any given quality of coal. Nearly 350 pages, fully illustrated. . . . \$1.00

CATALOGUE OF GOOD, PRACTICAL BOOKS

LINK MOTIONS, VALVES AND VALVE SETTING. By FRED H. COLVIN, Associate Editor of "American Machinist."

A handy book for the engineer or machinist that clears up the mysteries of valve setting. Shows the different valve gears in use, how they work, and why. Piston and slide valves of different types are illustrated and explained. A book that every railroad man in the motive power department ought to have. Contains chapters on Locomotive Link Motion, Valve Movements, Setting Slide Valves, Analysis by Diagrams, Modern Practice, Slip-of-Block, Slide Valves, Piston Valves, Setting Piston Valves, Joy-Allen Valve Gear, Walschaert Valve Gear, Gooch Valve Gear, Alfree-Hubbell Valve Gear, etc. Fully illustrated. Price 50 cents

LOCOMOTIVE BOILER CONSTRUCTION. By FRANK A. KLEINHANS.

The construction of boilers in general are treated, and following this, the locomotive boiler is taken up in the order in which its various parts go through the shop. Shows all types of boilers used; gives details of construction; practical facts, such as life of riveting, punches and dies; work done per day, allowance for bending and flanging sheets, and other data. Locomotive boilers present more difficulty in laying out and building than any other type, and for this reason the author uses them as examples. Anyone who can handle them can tackle anything. Contains chapters on Laying Out Work; Flanging and Forging; Punching; Shearing; Plate Planing; General Tables; Finishing Parts; Bending; Machinery Parts; Riveting; Boiler Details; Smoke Box Details; Assembling and Calking; Boiler Shop Machinery, etc., etc. There isn't a man who has anything to do with boiler work, either new or repair work, who doesn't need this book. The manufacturer, superintendent, foreman, and boiler worker—all need it. No matter what the type of boiler, you'll find a mint of information that you wouldn't be without. Over 400 pages, five large folding plates. Price \$3.00

LOCOMOTIVE BREAKDOWNS AND THEIR REMEDIES. By GEO. L. FOWLER. Revised by WM. W. WOOD, Air-Brake Instructor. Just issued. Revised pocket edition.

It is out of the question to try and tell you about every subject that is covered in this pocket edition of Locomotive Breakdowns. Just imagine all the common troubles that an engineer may expect to happen some time, and then add all of the unexpected ones, troubles that could occur, but that you had never thought about, and you will find that they are all treated with the very best methods of repair. Walschaert Locomotive Valve Gear Troubles, Electric Headlight Troubles, as well as Questions and Answers on the Air Brake are all included. 294 pages. Fully illustrated. \$1.00

LOCOMOTIVE CATECHISM. By ROBERT GRIMSHAW.

The revised edition of "Locomotive Catechism," by Robert Grimshaw, is a New Book from Cover to Cover. It contains twice as many pages and double the number of illustrations of previous editions. Includes the greatest amount of practical information ever published on the construction and management of modern locomotives. Specially Prepared Chapters on the Walschaert Locomotive Valve Gear, the Air Brake Equipment and the Electric Head Light are given. It commends itself at once to every Engineer and Fireman, and to all who are going in for examination or promotion. In plain language, with full complete answers, not only all the questions asked by the examining engineer are given, but those which the young and less experienced would ask the veteran, and which old hands ask as "stickers." It is a veritable Encyclopedia of the Locomotive, is entirely free from mathematics, easily understood and thoroughly up-to-date. Contains over 4,000 Examination Questions with their Answers. 825 pages, 437 illustrations and three folding plates. \$2.50

NEW YORK AIR-BRAKE CATECHISM. By ROBERT H. BLACKALL.

This is a complete treatise on the New York Air-Brake and Air-Signalling Apparatus, giving a detailed description of all the parts, their operation, troubles, and the methods of locating and remedying the same. 200 pages, fully illustrated. \$1.00

POCKET RAILROAD DICTIONARY AND VADE MECUM. By FRED H. COLVIN, Associate Editor "American Machinist."

The Railroad Pocket Book is of value to every man on the road, as it contains valuable Railroad Data, Master Car Builders' Standards, Tests, Proportions of Locomotives and Boilers and various other Rules and Tables. As a record of recent practice in all sections of railway work it stands alone, giving facts and figures from actual experience on such matters as Acetylene Lighting, Air Brakes, Axles, Bearings, Boilers, Cars, Costs of repairs and other items, Counterbalancing, Curves, Driving Wheels, Equalizers, Flues, Grades, Grates, Heating surfaces, Injectors, Locomotives, Maintenance of way, Oils, Power of Locomotives, Rails, Rods, Shops, Speed, Tires, Turntables, Valve Motions, Water, etc., etc. Second Edition. Price \$1.00

CATALOGUE OF GOOD, PRACTICAL BOOKS

TRAIN RULES AND DESPATCHING. By H. A. DALBY.

Every railroad man, no matter what department he's in, needs a copy of this book. It gives the standard rules for both single and double track, shows all the signals, with colors wherever necessary, and has a list of towns where time changes, with a map showing the whole country. The rules are explained wherever there is any doubt about their meaning or where they are modified by different railroads. It's the only practical book on train rules in print. Over 220 pages. Leather cover. Price \$1.50

WALSCHAERT LOCOMOTIVE VALVE GEAR. By Wm. W. Wood.

If you would thoroughly understand the Walschaert Valve Gear you should possess a copy of this book, as the author takes the plainest form of a steam engine—a stationary engine in the rough, that will only turn its crank in one direction—and from it builds up—with the reader's help—a modern locomotive equipped with the Walschaert Valve Gear, complete.

The points discussed are clearly illustrated: two large folding plates that show the positions of the valves of both inside or outside admission type, as well as the links and other parts of the gear when the crank is at nine different points in its revolution, are especially valuable in making the movement clear. These employ sliding cardboard models which are contained in a pocket in the cover.

The book is divided into four general divisions, as follows: I. Analysis of the gear. II. Designing and erecting the gear. III. Advantages of the gear. IV. Questions and answers relating to the Walschaert Valve Gear.

This last division contains sixty pertinent questions with full answers on all the features of this type of valve gear, which will be especially valuable to firemen and engineers in preparing for an examination for promotion. Nearly 200 pages. Price \$1.50

WESTINGHOUSE E-T AIR-BRAKE INSTRUCTION POCKET CATECHISM. By Wm. W. Wood, Air-Brake Instructor.

Here is a book for the railroad man, and the man who aims to be one. It is without doubt the only complete work published on the Westinghouse E-T Locomotive Brake Equipment. Written by an Air Brake Instructor who knows just what is needed. It covers the subject thoroughly. Everything about the New Westinghouse Engine and Tender Brake Equipment, including the Standard No. 5 and the Perfected No. 6 Style of brake, is treated in detail. Written in plain English and profusely illustrated with Colored Plates, which enable one to trace the flow of pressures throughout the entire equipment. The best book ever published on the Air Brake. Equally good for the beginner and the advanced engineer. Will pass any one through any examination. It informs and enlightens you on every point. Indispensable to every engineman and trainman.

Contains examination questions and answers on the E-T equipment. Covering what the E-T Brake is. How it should be operated. What to do when defective. Not a question can be asked of the engineman up for promotion on either the No. 5 or the No. 6 E-T equipment that is not asked and answered in the book. If you want to thoroughly understand the E-T equipment get a copy of this book. It covers every detail. Makes Air Brake troubles and examinations easy. Price \$1.50

MACHINE SHOP PRACTICE

AMERICAN TOOL MAKING AND INTERCHANGEABLE MANUFACTURING. By J. V.

WOODWORTH.

A "shoppy" book, containing no theorizing, no problematical or experimental devices, there are no badly proportioned and impossible diagrams, no catalogue cuts, but a valuable collection of drawings and descriptions of devices, the rich fruits of the author's own experience. In its 500-odd pages the one subject only, Tool Making, and whatever relates thereto, is dealt with. The work stands without a rival. It is a complete practical treatise on the art of American Tool Making and system of interchangeable manufacturing as carried on to-day in the United States. In it are described and illustrated all of the different types and classes of small tools, fixtures, devices, and special appliances which are in general use in all machine manufacturing and metal working establishments where economy, capacity and interchangeability in the production of machined metal parts are imperative. The science of jig making is exhaustively discussed, and particular attention is paid to drill jigs, boring, profiling and milling fixtures and other devices in which the parts to be machined are located and fastened within the contrivances. All of the tools, fixtures, and devices illustrated and described have been or are used for the actual production of work, such as parts of drill presses, lathes, patented machinery, typewriters, electrical apparatus, mechanical appliances, brass goods, composition parts, mould products, sheet metal articles, drop forgings, jewelry, watches, medals, coins, etc. 531 pages. Price \$4.00

HENLEY'S ENCYCLOPEDIA OF PRACTICAL ENGINEERING AND ALLIED TRADES.

Edited by JOSEPH G. HORNER, A. M. I., M. E.

This set of five volumes contains about 2,500 pages with thousands of illustrations, including diagrammatic and sectional drawings with full explanatory details. This work covers the entire practice of Civil and Mechanical Engineering. The best known experts in all branches of engineering have contributed to these volumes. The Cyclopaedia is admirably well adapted to the needs of the beginner and the self-taught practical man, as well as the mechanical engineer, designer, draftsman, shop superintendent, foreman, and machinist. The work will be found a means of advancement to any progressive man. It is encyclopedic in scope, thorough and practical in its treatment of technical subjects, simple and clear in its descriptive matter,

CATALOGUE OF GOOD, PRACTICAL BOOKS

and without unnecessary technicalities or formulae. The articles are as brief as may be and yet give a reasonably clear and explicit statement of the subject, and are written by men who have had ample practical experience in the matters of which they write. It tells you all you want to know about engineering and tells it so simply, so clearly, so concisely, that one cannot help but understand. As a work of reference it is without a peer. \$6.00 per single volume. For complete set of five volumes. Price \$25.00

MACHINE SHOP ARITHMETIC. By COLVIN-CHENEY.

This is an arithmetic of the things you have to do with daily. It tells you plainly about: how to find areas of figures; how to find surface or volume of balls or spheres; handy ways for calculating; about compound gearing; cutting screw threads on any lathe; drilling for taps; speeds of drills, taps, emery wheels, grindstones, milling cutters, etc.; all about the Metric system with conversion tables; properties of metals; strength of bolts and nuts; decimal equivalent of an inch. All sorts of machine shop figuring and 1,001 other things, any one of which ought to be worth more than the price of this book to you, and it saves you the trouble of bothering the boss. 131 pages. Price 50 cents

MECHANICAL MOVEMENTS, POWERS, AND DEVICES. By GARDNER D. HISCOX.

This is a collection of 1,890 engravings of different mechanical motions and appliances, accompanied by appropriate text, making it a book of great value to the inventor, the draftsman, and to all readers with mechanical tastes. The book is divided into eighteen sections or chapters in which the subject matter is classified under the following heads: Mechanical Powers; Transmission of Power; Measurement of Power, Steam Power; Air Power Appliances; Electric Power and Construction, Navigation and Roads; Gearing; Motion and Devices; Controlling Motion; Horological; Mining; Mill and Factory Appliances; Construction and Devices; Drafting Devices; Miscellaneous Devices, etc. 11th edition. 400 octavo pages. Price \$2.50

MECHANICAL APPLIANCES, MECHANICAL MOVEMENTS AND NOVELTIES OF CONSTRUCTION. By GARDNER D. HISCOX.

This is a supplementary volume to the one upon mechanical movements. Unlike the first volume, which is more elementary in character, this volume contains illustrations and descriptions of many combinations of motions and of mechanical devices and appliances found in different lines of machinery. Each device being shown by a line drawing with a description showing its working parts and the method of operation. From the multitude of devices described, and illustrated, might be mentioned, in passing, such items as conveyors and elevators, Prony brakes, thermometers, various types of boilers, solar engines, oil-fuel burners, condensers, evaporators, Corliss and other valve gears, governors, gas engines, water motors of various descriptions, air ships, motors and dynamos, automobile and motor bicycles, railway block signals, car coupes, link and gear motions, ball bearings, breech block mechanism for heavy guns, and a large accumulation of others of equal importance. 1,000 specially made engravings. 396 octavo pages. Price \$2.50

MODERN MACHINE SHOP CONSTRUCTION, EQUIPMENT AND MANAGEMENT. By OSCAR E. PERRIGO.

The only work published that describes the Modern Machine Shop or Manufacturing Plant from the time the grass is growing on the site intended for it until the finished product is shipped. Just the book needed by those contemplating the erection of modern shop buildings, the rebuilding and reorganization of old ones, or the introduction of Modern Shop Methods, time and cost systems. It is a book written and illustrated by a practical shop man for practical shop men who are too busy to read theories and want facts. It is the most complete all-around book of its kind ever published. 400 large quarto pages. 225 original and specially-made illustrations. Price \$5.00

MACHINE SHOP TOOLS AND SHOP PRACTICE. By W. H. VANDERVOORT.

A work of 555 pages and 673 illustrations, describing in every detail the construction, operation, and manipulation of both hand and machine tools. Includes chapters on filing, fitting, and scraping surfaces; on drills, reamers, taps, and dies; the lathe and its tools; planers, shapers, and their tools; milling machines and cutters; gear cutters and gear cutting; drilling machines and drill work; grinding machines and their work; hardening and tempering; gearing, belting and transmission machinery; useful data and tables. 5th edition. Price \$3.00

THE MODERN MACHINIST. By JOHN T. USHER.

This is a book showing, by plain description and by profuse engravings, made expressly for the work, all that is best, most advanced, and of the highest efficiency in modern machine shop practice, tools, and implements, showing the way by which and through which, as Mr. Maxim says, "American machinists have become and are the finest mechanics in the world." Indicating as it does, in every line, the familiarity of the author with every detail of daily experience in the shop, it cannot fail to be of service to any man practically connected with the shaping or finishing of metals. There is nothing experimental or visionary about the book, all devices being in actual use and giving good results. It might be called a compendium of shop methods, showing a variety of special tools and appliances which will give new ideas to many mechanics, from the superintendent down to the man at the bench. It will be found a valuable addition to any machinist's library, and should be consulted whenever a new or difficult job is to be done, whether it is boring, milling, turning, or planing, as they are all treated in a practical manner. Fifth Edition. 320 pages. 250 illustrations. Price. \$2.50

CATALOGUE OF GOOD, PRACTICAL BOOKS

MODERN MILLING MACHINES: THEIR DESIGN, CONSTRUCTION AND OPERATION. By JOSEPH G. HORNER.

This book describes and illustrates the Milling Machine and its work in such a plain, clear, and forceful manner, and illustrates the subject so clearly and completely, that the up-to-date machinist, student, or mechanical engineer cannot afford to do without the valuable information which it contains. It describes not only the early machines of this class, but notes their gradual development into the splendid machines of the present day, giving the design and construction of the various types, forms, and special features produced by prominent manufacturers, American and foreign.

Milling cutters in all their development and modernized forms are illustrated and described, and the operations they are capable of producing upon different classes of work are carefully described in detail, and the speeds and feeds necessary are discussed, and valuable and useful data given for determining these usually perplexing problems. The book is the most comprehensive work published on the subject. 304 pages. 300 illustrations. Price . . . \$4.00

MODERN MECHANISM. Edited by PARK BENJAMIN.

A practical treatise on machines, motors and the transmission of power, being a complete work and a supplementary volume to Appleton's Cyclopedic of Applied Mechanics. Deals solely with the principal and most useful advances of the past few years. 959 pages containing over 1,000 illustrations; bound in half morocco. \$4.00

"SHOP KINKS." By ROBERT GRIMSHAW.

A book of 400 pages and 222 illustrations, being entirely different from any other book on machine shop practice. Departing from conventional style, the author avoids universal or common shop usage and limits his work to showing special ways of doing things better, more cheaply and more rapidly than usual. As a result the advanced methods of representative establishments of the world are placed at the disposal of the reader. This book shows the proprietor where large savings are possible, and how products may be improved. To the employee it holds out suggestions that, properly applied, will hasten his advancement. No shop can afford to be without it. It bristles with valuable wrinkles and helpful suggestions. It will benefit all, from apprentice to proprietor. Every machinist, at any age, should study its pages. Fifth Edition. Price \$2.50

THREADS AND THREAD CUTTING. By COLVIN and STABEL.

This clears up many of the mysteries of thread-cutting, such as double and triple threads, internal threads, catching threads, use of hobs, etc. Contains a lot of useful hints and several tables. Price 25 cents

TOOLS FOR MACHINISTS AND WOOD WORKERS, INCLUDING INSTRUMENTS OF MEASUREMENT. By JOSEPH G. HORNER.

The principles upon which cutting tools for wood, metal, and other substances are made are identical, whether used by the machinist, the carpenter, or by any other skilled mechanic in their daily work, and the object of this book is to give a correct and practical description of these tools as they are commonly designed, constructed, and used. 340 pages, fully illustrated. Price \$3.50

MANUAL TRAINING

ECONOMICS OF MANUAL TRAINING. By LOUIS ROUILLON.

The only book published that gives just the information needed by all interested in Manual Training, regarding Buildings, Equipment, and Supplies. Shows exactly what is needed for all grades of the work from the Kindergarten to the High and Normal School. Gives itemized lists of everything used in Manual Training Work and tells just what it ought to cost. Also shows where to buy supplies, etc. Contains 174 pages, and is fully illustrated. Price \$1.50

MARINE ENGINEERING

MARINE ENGINES AND BOILERS, THEIR DESIGN AND CONSTRUCTION. By DR. G. BAUER, LESLIE S. ROBERTSON, and S. BRYAN DONKIN.

In the words of Dr. Bauer, the present work owes its origin to an oft felt want of a Condensed Treatise, embodying the Theoretical and Practical Rules used in Designing Marine Engines and Boilers. The need for such a work has been felt by most engineers engaged in the construction and working of Marine Engines, not only by the younger men, but also by those of greater experience. The fact that the original German work was written by the chief engineer of the famous Vulcan Works, Stettin, is in itself a guarantee that this book is in all respects thoroughly up-to-date, and that it embodies all the information which is necessary for the design and construction of the highest types of marine engines and boilers. It may be said, that the motive power which Dr. Bauer has placed in the fast German liners that have been turned out of late years from the Stettin Works, represent the very best practice in marine engineering of the present day.

This work is clearly written, thoroughly systematic, theoretically sound; while the character of its plans, drawings, tables, and statistics is without reproach. The illustrations are careful reproductions from actual working drawings, with some well-executed photographic views of completed engines and boilers. 722 pages. 550 illustrations. . . . \$9.00 net

CATALOGUE OF GOOD, PRACTICAL BOOKS

MINING

ORE DEPOSITS, WITH A CHAPTER ON HINTS TO PROSPECTORS. By J. P. JOHNSON.

This book gives a condensed account of the ore-deposits at present known in South Africa. It is also intended as a guide to the prospector. Only an elementary knowledge of geology and some mining experience are necessary in order to understand this work. With these qualifications, it will materially assist one in his search for metalliferous mineral occurrences and, so far as simple ores are concerned, should enable one to form some idea of the possibilities of any they may find.

Among the chapters given are: Titaniferous and Chromiferous Iron Oxides—Nickel—Copper—Cobalt—Tin—Molybdenum—Tungsten—Lead—Mercury—Antimony—Iron—Hints to Prospectors. \$2.00

PRACTICAL COAL MINING. By T. H. COCKIN.

An important work, containing 428 pages and 213 illustrations, complete with practical details, which will intuitively impart to the reader, not only a general knowledge of the principles of coal mining, but also considerable insight into allied subjects. The treatise is positively up to date in every instance, and should be in the hands of every colliery engineer, geologist, mine operator, superintendent, foreman, and all others who are interested in or connected with the industry. \$2.50

PHYSICS AND CHEMISTRY OF MINING. By T. H. BYROM.

A practical work for the use of all preparing for examinations in mining or qualifying for colliery managers' certificates. The aim of the author in this excellent book is to place clearly before the reader useful and authoritative data which will render him valuable assistance in his studies. The only work of its kind published. The information incorporated in it will prove of the greatest practical utility to students, mining engineers, colliery managers, and all others who are specially interested in the present-day treatment of mining problems. Among its contents are chapters on: The Atmosphere; Laws Relating to the Behavior of Gases; The Diffusion of Gases; Composition of the Atmosphere: Sundry Constituents of the Atmosphere; Water; Carbon; Fire-Damp; Combustion; Coal Dust and Its Action; Explosives; Composition of Various Coals and Fuels; Methods of Analysis of Coal; Strata Adjoining the Coal Measures; Magnetism and Electricity; Appendix; Useful Tables, etc.; Miscellaneous Questions. 160 pages. Illustrated. \$2.00

PATTERN MAKING

PRACTICAL PATTERN MAKING. By F. W. BARROWS.

This is a very complete and entirely practical treatise on the subject of pattern making, illustrating pattern work in wood and metal. From its pages you are taught just what you should know about pattern making. It contains a detailed description of the materials used by pattern makers, also the tools, both those for hand use, and the more interesting machine tools; having complete chapters on the band saw, The Buzz Saw, and the Lathe. Individual patterns of many different kinds are fully illustrated and described, and the mounting of metal patterns on plates for molding machines is included. Price \$2.00

PERFUMERY

HENLEY'S TWENTIETH CENTURY BOOK OF RECEIPTS, FORMULAS AND PROCESSES

Edited by G. D. HISCOX.

The most valuable Techno-chemical Receipt Book published. Contains over 10,000 practical receipts, many of which will prove of special value to the perfumer, a mine of information, up-to-date in every respect. Price, Cloth, \$3.00; half morocco \$4.00

PERFUMES AND THEIR PREPARATION. By G. W. ASKINSON, Perfumer.

A comprehensive treatise, in which there has been nothing omitted that could be of value to the Perfumer. Complete directions for making handkerchief perfumes, smelling-salts, sachets, fumigating pastilles; preparations for the care of the skin, the mouth, the hair, cosmetics, hair dyes and other toilet articles are given, also a detailed description of aromatic substances; their nature, tests of purity, and wholesale manufacture. A book of general, as well as professional interest, meeting the wants not only of the druggist and perfume manufacturer, but also of the general public. Third edition. 312 pages, Illustrated. . . \$3.00

CATALOGUE OF GOOD, PRACTICAL BOOKS

PLUMBING

MECHANICAL DRAWING FOR PLUMBERS. By R. M. STARBUCK.

A concise, comprehensive and practical treatise on the subject of mechanical drawing in its various modern applications to the work of all who are in any way connected with the plumbing trade. Nothing will so help the plumber in estimating and in explaining work to customers and workmen as a knowledge of drawing, and to the workman it is of inestimable value if he is to rise above his position to positions of greater responsibility. 150 illustrations. Price \$1.50

MODERN PLUMBING ILLUSTRATED. By R. M. STARBUCK.

This book represents the highest standard of plumbing work. It has been adopted and used as a reference book by the United States Government, in its sanitary work in Cuba, Porto Rico, and the Philippines, and by the principal Boards of Health of the United States and Canada.

It gives connections, sizes and working data for all fixtures and groups of fixtures. It is helpful to the master plumber in demonstrating to his customers and in figuring work. It gives the mechanic and student quick and easy access to the best modern plumbing practice. Suggestions for estimating plumbing construction are contained in its pages. This book represents, in a word, the latest and best up-to-date practice, and should be in the hands of every architect, sanitary engineer and plumber who wishes to keep himself up to the minute on this important feature of construction. 400 octavo pages, fully illustrated by 55 full-page engravings. Price \$4.00

STANDARD PRACTICAL PLUMBING. By R. M. STARBUCK.

A complete practical treatise of 450 pages covering the subject of Modern Plumbing in all its Branches, a large amount of space being devoted to a very complete and practical treatment of the subject of Hot Water Supply and Circulation and Range Boiler Work. Its thirty chapters include about every phase of the subject, one can think of, making it an indispensable work to the master plumber, the journeyman plumber, and the apprentice plumber. Fully illustrated by 347 engravings. Price \$3.00

RECEIPT BOOK

HENLEY'S TWENTIETH CENTURY BOOK OF RECEIPTS, FORMULAS AND PROCESSES.

Edited by GARDNER D. HISCOX.

The most valuable Techno-chemical Receipt Book published, including over 10,000 selected scientific, chemical, technological, and practical receipts and processes.

This is the most complete Book of Receipts ever published, giving thousands of receipts for the manufacture of valuable articles for everyday use. Hints, Helps, Practical Ideas, and Secret Processes are revealed within its pages. It covers every branch of the useful arts and tells thousands of ways of making money and is just the book everyone should have at his command. 800 pages. Price \$3.00

RUBBER

RUBBER HAND STAMPS AND THE MANIPULATION OF INDIA RUBBER. By T. O'CONNOR SLOANE.

This book gives full details on all points, treating in a concise and simple manner the elements of nearly everything it is necessary to understand for a commencement in any branch of the India Rubber Manufacture. The making of all kinds of Rubber Hand Stamps, Small Articles of India Rubber, U. S. Government Composition, Dating Hand Stamps, the Manipulation of Sheet Rubber, Toy Balloons, India Rubber Solutions, Cements, Blackings, Renovating Varnish, and Treatment for India Rubber Shoes, etc.; the Hektograph Stamp Inks, and Miscellaneous Notes, with a Short Account of the Discovery, Collection, and Manufacture of India Rubber are set forth in a manner designed to be readily understood, the explanations being plain and simple. Second edition. 144 pages. Illustrated. \$1.00

SAWS

SAW FILINGS AND MANAGEMENT OF SAWS. By ROBERT GRIMSHAW.

A practical hand book on filing, gumming, swaging, hammering, and the brazing of band saws, the speed, work, and power to run circular saws, etc. A handy book for those who have charge of saws, or for those mechanics who do their own filing, as it deals with the proper shape and pitches of saw teeth of all kinds and gives many useful hints and rules for gumming, setting, and filing, and is a practical aid to those who use saws for any purpose. New edition, revised and enlarged Illustrated. Price \$1.00

CATALOGUE OF GOOD, PRACTICAL BOOKS

STEAM ENGINEERING

AMERICAN STATIONARY ENGINEERING. By W. E. CRANE.

This book begins at the boiler room and takes in the whole power plant. A plain talk on every-day work about engines, boilers, and their accessories. It is not intended to be scientific or mathematical. All formulas are in simple form so that any one understanding plain arithmetic can readily understand any of them. The author has made this the most practical book in print; has given the results of his years of experience, and has included about all that has to do with an engine room or a power plant. You are not left to guess at a single point. You are shown clearly what to expect under the various conditions; how to secure the best results; ways of preventing "shut downs" and repairs; in short, all that goes to make up the requirements of a good engineer, capable of taking charge of a plant. It's plain enough for practical men and yet of value to those high in the profession. Has a complete examination for a license. \$2.00

EMINENT ENGINEERS. By DWIGHT GODDARD.

Everyone who appreciates the effect of such great inventions as the Steam Engine, Steamboat, Locomotive, Sewing Machine, Steel Working, and other fundamental discoveries, is interested in knowing a little about the men who made them and their achievements. Mr. Goddard has selected thirty-two of the world's engineers who have contributed most largely to the advancement of our civilization by mechanical means, giving only such facts as are of general interest and in a way which appeals to all, whether mechanics or not. 280 pages. 35 illustrations. Price \$1.50

ENGINE RUNNER'S CATECHISM. By ROBERT GRIMSHAW.

A practical treatise for the stationary engineer, telling how to erect, adjust and run the principal steam engines in use in the United States. Describing the principal features of various special and well-known makes of engines: Temper Cut-off, Shipping and Receiving Foundations, Erecting and Starting, Valve Setting, Care and Use, Emergencies, Erecting and Adjusting Special Engines. The questions asked throughout the catechism are plain and to the point, and the answers are given in such simple language as to be readily understood by anyone. All the instructions given are complete and up-to-date; and they are written in a popular style, without any technicalities or mathematical formulae. The work is of a handy size for the pocket, clearly and well printed, nicely bound, and profusely illustrated. To young engineers this catechism will be of great value, especially to those who may be preparing to go forward to be examined for certificates of competency; and to engineers generally it will be of no little service, as they will find in this volume more really practical and useful information than is to be found anywhere else within a like compass. 387 pages. Seventh edition. Price. \$2.00

ENGINE TESTS AND BOILER EFFICIENCIES. By J. BUCHETTI.

This work fully describes and illustrates the method of testing the power of steam engines, turbines and explosive motors. The properties of steam and the evaporative power of fuels. Combustion of fuel and chimney draft; with formulas explained or practically computed. 255 pages, 179 illustrations. \$3.00

HORSE POWER CHART.

Shows the horse power of any stationary engine without calculation. No matter what the cylinder diameter of stroke; the steam pressure or cut-off; the revolutions, or whether condensing or non-condensing, it's all there. Easy to use, accurate, and saves time and calculations. Especially useful to engineers and designers. 50 cents

MODERN STEAM ENGINEERING IN THEORY AND PRACTICE. By GARDNER D. HISCOX

This is a complete and practical work issued for Stationary Engineers and firemen dealing with the care and management of boilers, engines, pumps, superheated steam, refrigerating machinery, dynamos, motors, elevators, air compressors, and all other branches with which the modern engineer must be familiar. Nearly 200 questions with their answers on steam and electrical engineering, likely to be asked by the Examining Board, are included. 487 pages. 405 engravings. Price \$3.00

STEAM ENGINE CATECHISM. By ROBERT GRIMSHAW.

This unique volume of 413 pages is not only a catechism on the question and answer principle; but it contains formulas and worked-out answers for all the Steam problems that appertain to the operation and management of the Steam Engine. Illustrations of various valves and valve gear with their principles of operation are given. Thirty-four Tables that are indispensable to every engineer and fireman that wishes to be progressive and is ambitious to become master of his calling are within its pages. It is a most valuable instructor in the service of Steam Engineering. Leading engineers have recommended it as a valuable educator for the beginner as well as a reference book for the engineer. It is thoroughly indexed for every detail. Every essential question on the Steam Engine with its answer is contained in this valuable work. Sixteenth edition. Price \$2.00

CATALOGUE OF GOOD, PRACTICAL BOOKS

STEAM ENGINEER'S ARITHMETIC. By COLVIN-CHENEY.

A practical pocket book for the steam engineer. Shows how to work the problems of the engine room and shows "why." Tells how to figure horse-power of engines and boilers; area of boilers; has tables of areas and circumferences; steam tables; has a dictionary of engineering terms. Puts you on to all of the little kinks in figuring whatever there is to figure around a power plant. Tells you about the heat unit; absolute zero; adiabatic expansion; duty of engines; factor of safety; and 1,001 other things; and everything is plain and simple—not the hardest way to figure, but the easiest. 50 cents

STEAM HEATING AND VENTILATION

PRACTICAL STEAM, HOT-WATER HEATING AND VENTILATION. By A. G. KING.

This book is the standard and latest work published on the subject and has been prepared for the use of all engaged in the business of steam, hot water heating, and ventilation. It is an original and exhaustive work. Tells how to get heating contracts, how to install heating and ventilating apparatus, the best business methods to be used, with "Tricks of the Trade" for shop use. Rules and data for estimating radiation and cost, and such tables and information as make it an indispensable work for everyone interested in steam, hot water heating, and ventilation. It describes all the principal systems of steam, hot water, vacuum, vapor, and vacuum-vapor heating, together with the new accelerated systems of hot water circulation, including chapters on up-to-date methods of ventilation and the fan or blower system of heating and ventilation. 367 pages. 300 detailed engravings. Price \$3.00

STEAM PIPES

STEAM PIPES: THEIR DESIGN AND CONSTRUCTION. By WM. H. BOOTH.

This book fills in a deep gap in scientific literature, as there has been very little written on the practical side of steam pipe construction. Steam piping to-day is such a costly item, and the successful operation of a large plant depends so much upon it, that the problem of minimum cost and maximum efficiency becomes very important. The work is well illustrated in regard to pipe joints, expansion offsets, flexible joints, and self-contained sliding joints for taking up the expansion of long pipes. In fact, the chapters on the flow of steam and expansion of pipes are most valuable to all steam fitters and users. The pressure strength of pipes and method of hanging them is well treated and illustrated. Valves and by-passes are fully illustrated and described, as are also flange joints and their proper proportions, exhaust heads and separators. One of the most valuable chapters is that on superheated steam and the saving of steam by insulation with the various kinds of felting and other materials with comparison tables of the loss of heat in thermal units from naked and felted steam pipes. Contains 187 pages. Price \$2.00

STEEL

AMERICAN STEEL WORKER. By E. R. MARKHAM.

This book tells how to select, and how to work, temper, harden, and anneal steel for everything on earth. It doesn't tell how to temper one class of tools and then leave the treatment of another kind of tool to your imagination and judgment, but it gives careful instructions for every detail of every tool, whether it be a tap, a reamer or just a screw-driver. It tells about the tempering of small watch springs, the hardening of cutlery, and the annealing of dies. In fact there isn't a thing that a steel worker would want to know that isn't included. Price \$2.50

HARDENING, TEMPERING, ANNEALING, AND FORGING OF STEEL. By J. V. WOODWORTH.

A new work treating in a clear, concise manner all modern processes for the heating, annealing, forging, welding, hardening, and tempering of steel, making it a book of great practical value to the metal-working mechanic in general, with special directions for the successful hardening and tempering of all steel tools used in the arts, including milling cutters, taps, thread dies, reamers, both solid and shell, hollow mills, punches and dies, and all kinds of sheet metal working tools, shear blades, saws, fine cutlery, and metal cutting tools of all description, as well as for all implements of steel both large and small. In this work the simplest and most satisfactory hardening and tempering processes are given.

The uses to which the leading brands of steel may be adapted are concisely presented, and their treatment for working under different conditions explained, also the special methods for the hardening and tempering of special brands.

A chapter devoted to the different processes for Case-hardening is also included, and special reference made to the adoption of machinery steel for tools of various kinds. Price \$2.50

WATCH MAKING

WATCHMAKER'S HANDBOOK. By CLAUDIUS SAUNIER.

This famous work has now reached its seventh edition and there is no work issued that can compare to it for clearness and completeness. It contains 493 pages and is intended as a workshop companion for those engaged in Watch-making and allied Mechanical Arts. Nearly 250 engravings and fourteen plates are included. Price \$3.00



TEMG
W

574570

Woodworth, Joseph Vincent
Drop forging, die sinking and machine
forming of steel . . .

DATE

NAME

UNIVERSITY OF TORONTO
LIBRARY

DO NOT
REMOVE
THE
CARD
FROM
THIS
POCKET



